

Chapter One: Characteristics Of Living Organisms

In order to identify living organisms, scientists listed 7 characteristics which all living organisms have:

Nutrition: Taking in nutrients which are organic substances and mineral ions, containing raw materials and energy for growth and tissue repair, absorbing and assimilating them.

Excretion: Removal from organisms of toxic materials, the waste products of metabolism and substances in excess.

Respiration: Chemical reactions that break down nutrient molecules in living cells to release energy.

Sensitivity: The ability to detect or sense changes in the environment and to make responses.

Reproduction: Progresses that make more of the same kind of organism.

Growth: The permanent increase in size and dry mass by an increase in number of cells, cell size, or both.

Movement: An action by an organism or part of an organism that changes position or place.

The seven characteristics could be memorized by the term “Mrs. Gren”:

Movement

Respiration

Sensitivity

Growth

Reproduction

Excretion

Nutrition

Definitions:

Metabolism: Chemical reactions taking place in cells.

Stimuli: Changes in the environment which organisms response to.

Chapter 2: Lab Skills And Separating

Methods:

This unit deals with lab equipment and methods of separating solutions.

The following is a list of commonly used lab equipment:



Test Tube



Beaker



Conical flask



Burette

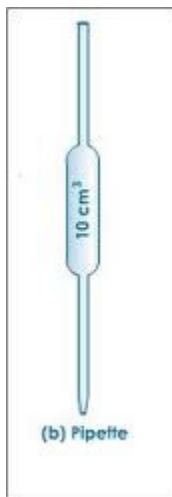

pipette



teat pipette (dropper)



Measuring Cylinder



Round Bottom Flask

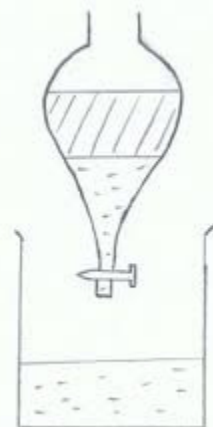

Separating Funnel



Bunsen Burner



Tripod



Gauze



Thermometer



Evaporating Dish



Balance



Safety Goggles



Mortar and Pestle

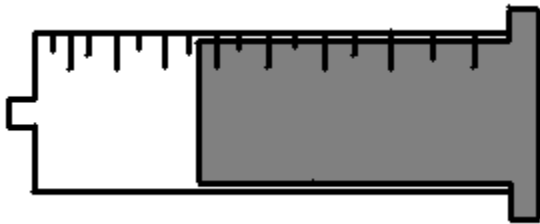

Gas Syringe



Crucible and Lid



Spatula



Condenser

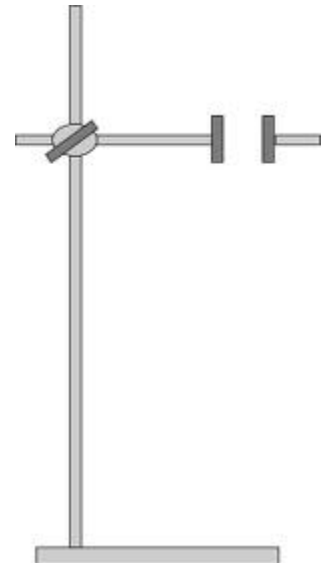

Stand and Clamp

Speaking about the chemistry of matter, we have only 3 types of matter. These are elements, mixtures and compounds. Long ago, scientists found out that the smallest unit of a matter is called an atom. An element is extremely pure because it is made up of only one type of atoms. For example a pure gold ring has only the element Gold (Au) in it. Compounds are very pure too, a compound is made up of one type of a particle called molecule. A molecule consists of two or more atoms chemically bonded together. Carbon Dioxide (CO_2) gas is a compound. A mixture however is not pure at all. A mixture is just two or more elements or compounds mixed together, but not chemically bonded. For example if you dissolve some table salt, which is a compound called sodium chloride (NaCl) in some water, which is also another compound (H_2O), you will get a mixture of Sodium Chloride in water, but there are absolutely no bonds between the Sodium Chloride molecules and water molecules. Air is another good example of mixtures. Air is just a mixture of gases floating around each other like Nitrogen and Oxygen, which are pure elements. Air also contains compounds such as Carbon Dioxide.



These nails are made up of an element called Iron (Fe)



These marbles are made up of the compound Calcium Carbonate (CaCO_3)



Sea water is a mixture of Salts and Water

Elements: Elements are substances that consist of only one kind of atoms and cannot be broken down into simpler substances by chemical means.

Elements, compounds and mixtures can be represented by diagrams like this, where circles of different sizes and colours represent different atoms. Circles attached to each other mean that they are chemically bonded forming a molecule.

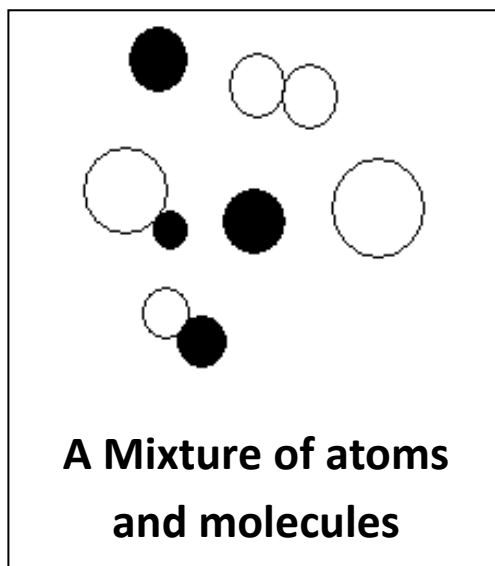
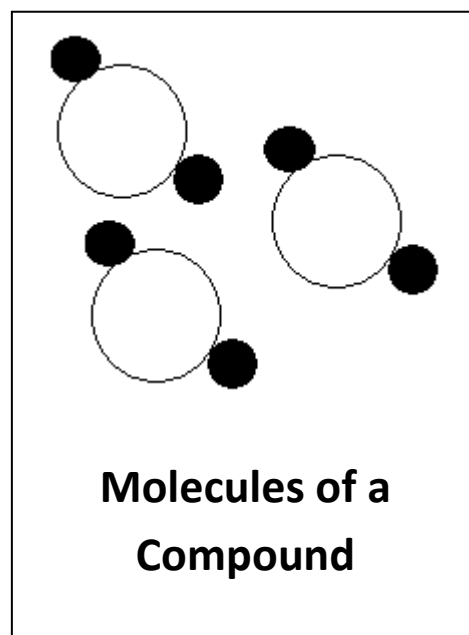
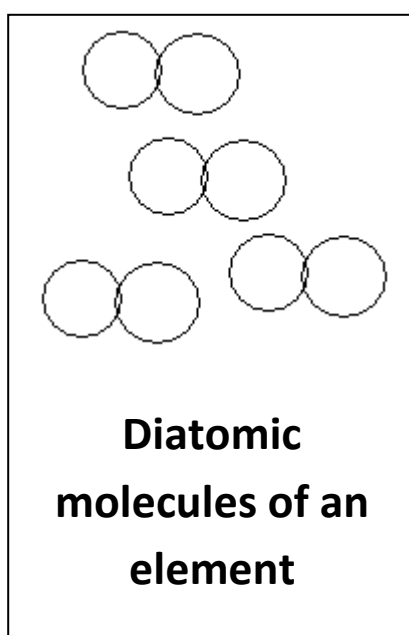
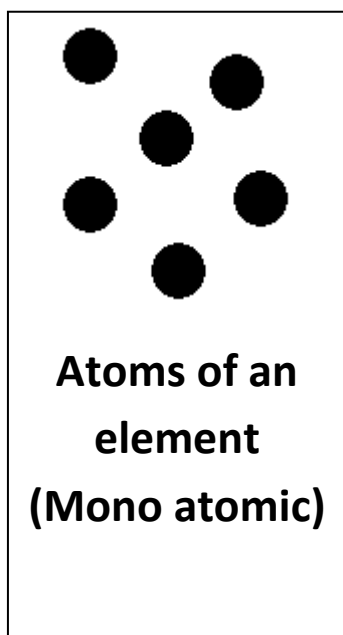

Diatomic Molecules are molecules made of two atoms of the same element, such as Chlorine molecules (Cl_2) and Oxygen molecules (O_2).

Since particles in mixtures have no chemical bonding between them, they could be easily separated by physical means. The method of separation however depends on the type of the mixture, and some of the physical properties of its components.

We have 4 types of mixtures:

- Solid/Solid mixtures
- Solid/liquid mixtures
- Liquid/liquid mixtures
- Gas/gas mixtures

Separating Solid/Solid Mixtures:

By Magnet:

This method is used to separate a mixture of two solids. One condition must be present though. This is that one of the solids is magnetic. For example if we have a mixture of sand and iron chips. We can separate them by following these instructions:

- Pour the mixture in a dish
- Approach a magnet just above the mixture

The iron chips will immediately get attracted to the magnet leaving sand behind.

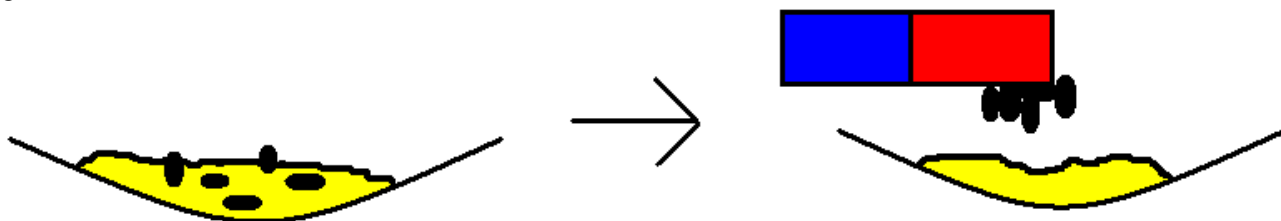

By Sublimation:

If we have a mixture of two solids, one of them undergoes sublimation we can easily separate them by heating the mixture using a Bunsen burner. One solid might melt while the other one will directly sublime into a gas. This process must be done in a fume cupboard in order to collect the gas.

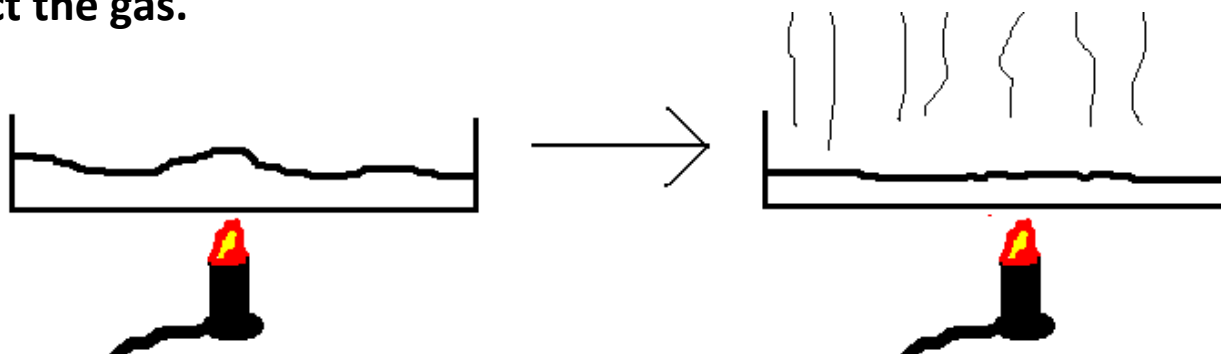

By Solvent Extraction Method:

This method is used one of the solids is water soluble, while the other is insoluble, For example a sand and salt mixture. In this method, the mixture is put in a beaker and water is added to it. The mixture is stirred on gentle heating to make the salt dissolve in the water quickly. Then the mixture is filtered using a filter funnel and filter paper. The residue will be the insoluble sand and the filtrate will be the salt solution. The sand is dried and collected. The salt is obtained from the solution by either the evaporation or the crystallisation method which will be studied later on.

Solubility:

A solution is formed when a solute is dissolved in a solvent.

Solute: This is a substance that dissolves in a solvent forming a solution

Solvent: This is a substance in which a solute dissolves forming a solution

Solution: A uniform mixture which is formed when a solute is dissolved in a solvent.

Dilute Solution: A solution with a small amount of solute/dm³.

Concentrated Solution: A solution with a large amount of solute/dm³.

Concentration: The amount of solute (in grams or moles) that can dissolve in 1dm³ of a solvent.

Saturated Solution: A very concentrated solution with the maximum amount of solute that dissolve in it already dissolved in it.

If you leave a hot saturated solution to cool, crystals of the solute will form. This is because as the temperature decreases the solvent can hold less solute so excess will form in the form of crystals.

The rate of dissolving can be increased by:

- Increasing temperature
- More stirring
- Crushed solute (larger surface area)

Solubility: The maximum amount of solute that can dissolve in 100g of water at a particular temperature.

If we want to find the solubility of table salt (sodium chloride) at 30 °C, we do the follow these steps:

- Use a balance to measure 100g of water accurately.
- Pour the 100g of water into a beaker
- Heat the water to 30°C using a Bunsen burner and a thermometer
- Using a spatula, add a considerable mass of the table salt into the water and stir
- If the mass of salt dissolves completely, add the same amount again and stir, repeat this if the mass keeps dissolving completely until you start seeing excess of the salt not dissolving at the bottom of the beaker.
- You have to record the masses of salt you are adding each time and when you start seeing the excess stop adding salt and sum up the amount of salt you added. Call this $Mass_1$.
- Filter the solution. The excess of salt will be the residue, dry it and weigh it. Call this $Mass_2$.
- The amount of table salt that was dissolved in water is $Mass_1 - Mass_2$.
- This is the solubility of table salt at 30°C.

Solubility increases as temperature increases. This is because the intermolecular spaces between the water molecules increase with temperature, giving more space for the solute's molecules.

By Evaporation (For Soluble Solid/Liquid Solutions).

- Put solution in a beaker
- Set the apparatus (Tripod with a gauze above it and a Bunsen burner below it)
- Put the beaker on the gauze
- Start heating the solution slowly

The liquid will evaporate completely leaving the solute behind in powder form.

By Crystallisation (For Soluble Solid/Liquid Solutions):

- Put solution in a beaker
- Set the apparatus (Tripod with a gauze above it and a Bunsen burner below it)
- Insert a glass rod in the beaker
- Turn on the Bunsen burner and continuously dip the glass rod in the solution
- When you see crystals of the solute starting to form on the glass rod, turn off the Bunsen burner. (This is crystallisation point)
- Leave the solution to cool
- Filter the solution and take the crystals, which will be the residue
- Wash the crystals with distilled water then dry them between two filter papers.

Not: do not dry the crystals in the oven because it will evaporate the water of crystallisation turning it into powder.

By Simple Distillation (For Soluble Solid/Liquid Solutions).

- Set the apparatus as shown in the diagram below
- Turn on the Bunsen burner
- The solvent will evaporate and rise as vapor into the condenser
- The cold water surrounding the tube where the water is in the condenser will make the vapor condense into liquid
- The solvent is collected in the tube or beaker on the other side of the condenser, its called the distillate.
- The solute is collected in the flask as powder.
- The thermometer must be where the vapor passes the measure the boiling point of the solvent.

This method is perfect for distilling sea water.

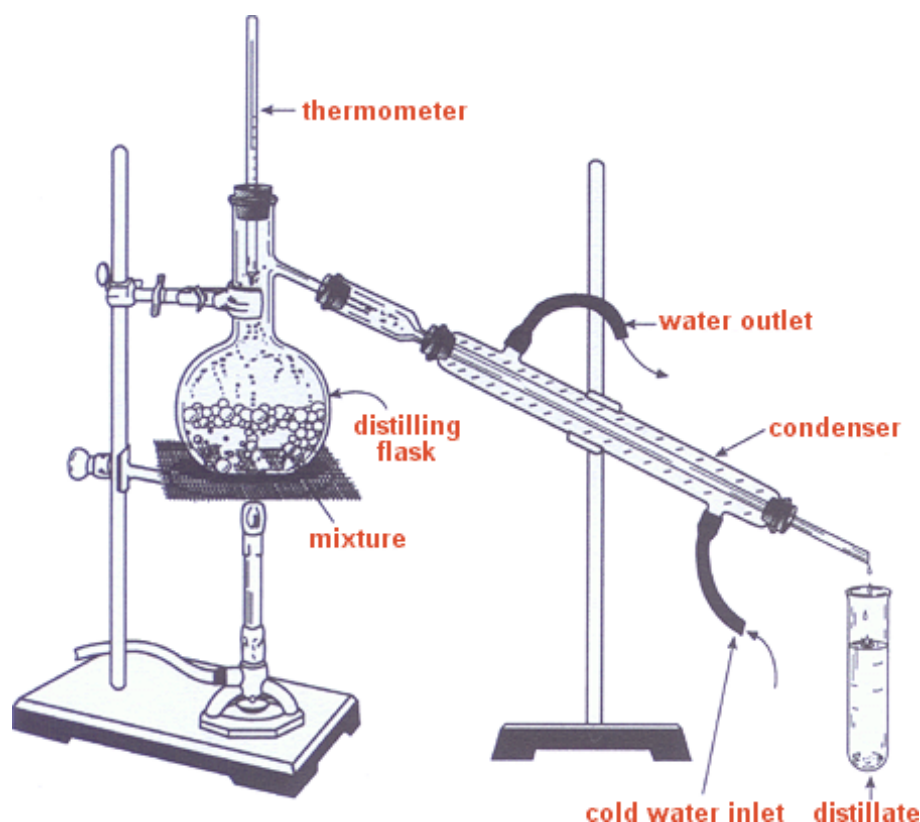

Filtration (For Insoluble Solid/Liquid Mixtures).

- Set the apparatus as shown in the diagram below
- Pour the mixture into the filter funnel
- The solvent will go through and be collected in the beaker as the filtrate
- The insoluble solid will be collected from the funnel as the residue.

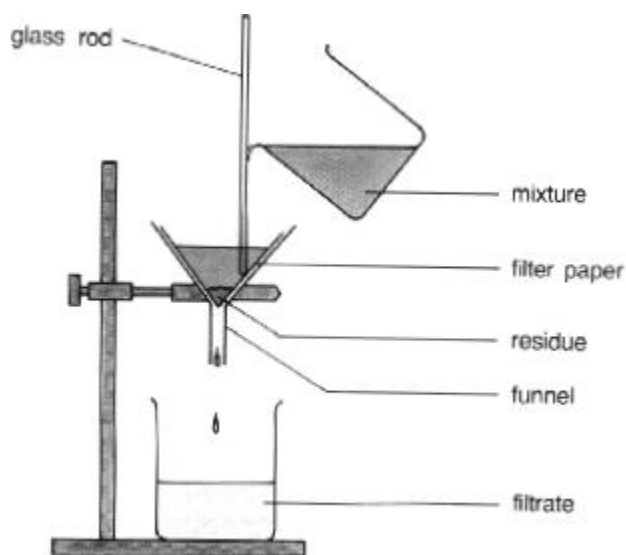
**Decantation (For Insoluble Solid/Liquid Mixtures):**

This method is very simple. It involves letting the insoluble solid rest at the bottom of the beaker. Then pouring the liquid in another beaker leaving the solid behind.



Centrifugation (For Insoluble Solid/Liquid mixtures).

- Put the mixture in a test tube
- Place the test tube in the centrifugation machine
- Start the machine

The centrifugation force will make the mixture separate into two layers, the liquid at the top, and solid at the bottom. They are then separated by decantation.

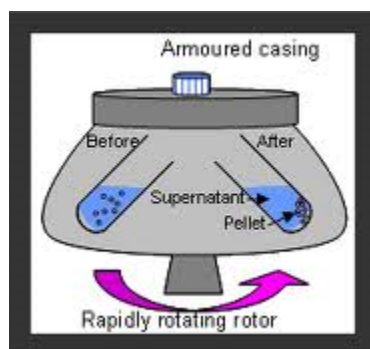

Separating Liquid/Liquid Mixtures:

Separating Funnel (For Immiscible Liquids):

Immiscible liquids do not mix together. Like oil and water. If they are put in one container, the denser liquid will settle at the bottom and the lighter one will go above it. To separate and oil and water mixture, we pour the mixture into the separating funnel. The water is denser than oil, it settles below it. The tap is opened to let the water flow into the beaker. The tap is closed when all the water is poured, the beaker is replaced by an empty one and the oil is now poured.

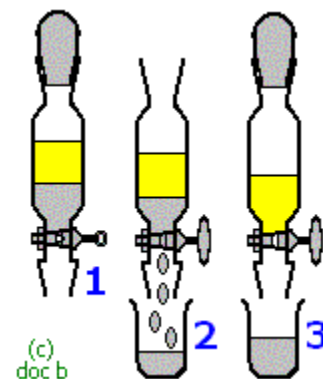

Fractional Distillation (For Miscible Liquids).

Fractional distillation is a method of separating a mixture of two or more liquids provided that they have different boiling points.

- The apparatus is set as in the diagram below
- When the heat is turned on the vapor of all the liquids rises
- The liquid with the lowest boiling point goes all the way through the glass beads and into the condenser and out on the other side as liquid. The temperature is constant during this.
- The liquids with the higher boiling points condense on the glass beads. When all of the liquid with the lowest boiling point have evaporated and collected, the temperature starts rising again. The liquid with the second lowest boiling point evaporates now, and gets collected on the other side. And so on.

The glass beads are to provide a cool large surface area for condensation.

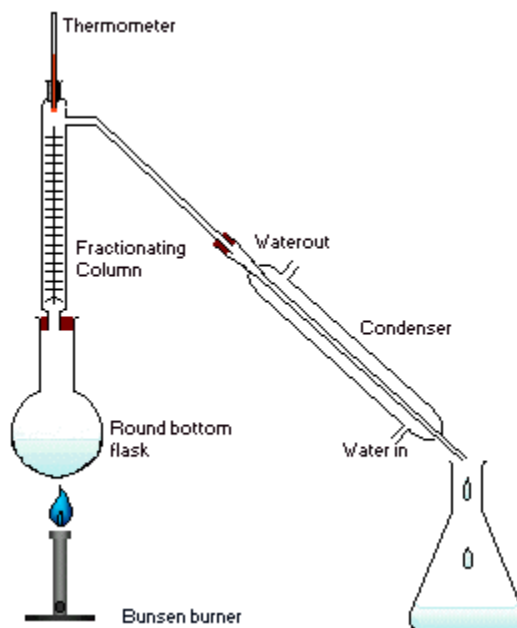

Fractional Distillation of Crude Oil:

Crude oil is a mixture of hydrocarbons. It is the major source of fuel. It is refined and separated into several very useful fractions by fractional distillation in a fractionating tower. The higher the fraction is obtained in the fractionating tower the lower its boiling point.

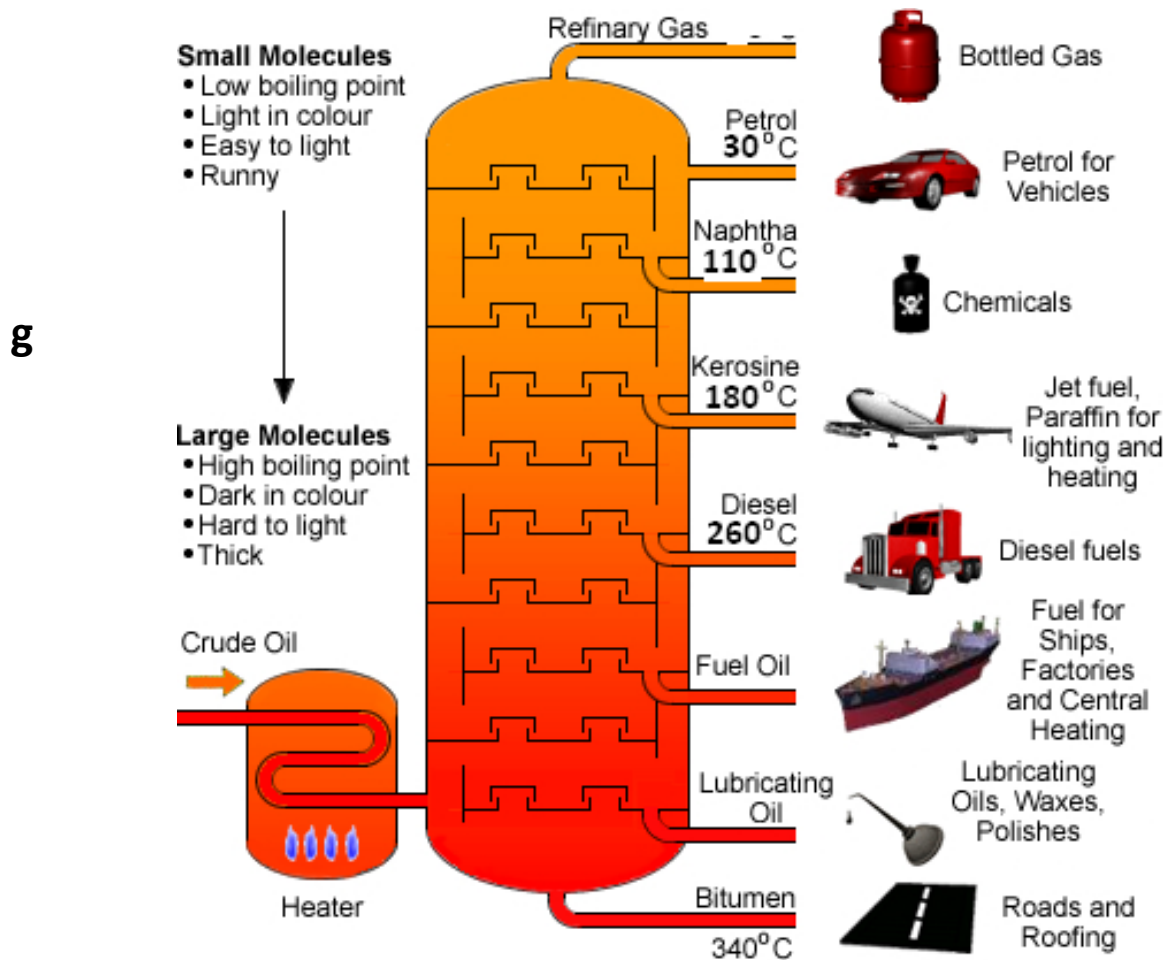

Fuel is a substance that releases energy (Eg: Coal, Natural gas, Ethanol)

Lubricant is a substance that reduces friction between two surfaces.

Hydrocarbons are organic compounds containing carbon and hydrogen only.

Different hydrocarbons are collected at different levels according to their boiling points. The higher they are collected the lower their boiling point

Chromatography is a process used to separate and identify two or more substances from a mixture. This method depends on the solubility of the tested substances. Chromatography is also used to find out the number of components in a drink for example.

Let's say we want to find the number of coloured dyes present in black ink. First we get a piece of filter paper or chromatography paper. We draw a line, in pencil, at the bottom of the paper. This line is called the base line, and the reason it is drawn in pencil is because pencil is insoluble so it won't interfere with the solubility of the ink. Then we place a spot of the black ink on the base line. The chromatography paper is now put with its bottom soaked in a suitable solvent, which is in our case water. The chromatography paper is going to absorb the solvent, which moves upwards. When the solvent reaches the base line, the spot of black ink will dissolve in it. The solvent will keep moving upwards taking with it the black ink. The more soluble the contents of the ink the higher it will move until it can't anymore.

www.studyguide.pk
The apparatus should look like this.

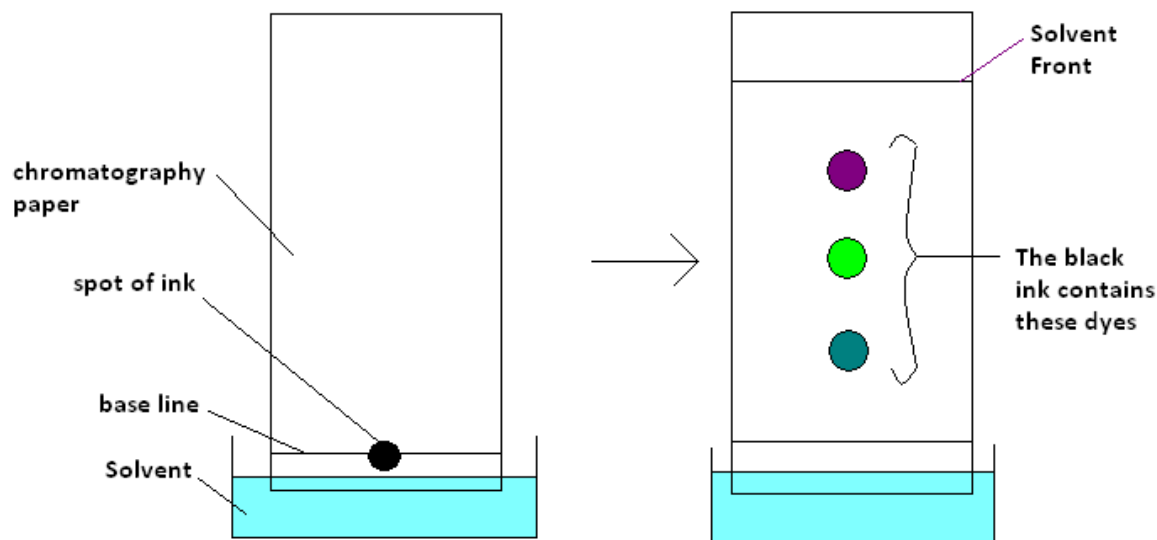

Sometimes the substance we are testing is in solid form. In this case we have to crush and dissolve it in water and filter it. We then take the filtrate and evaporate some of its water to get the most concentrated sample. Then we are ready to do the experiment.

When dealing with ethanol in concentrating the sample. We have to heat it in a water bath because it is flammable. And when we use it as a solvent in chromatography, it has to be performed in a covered beaker because ethanol is volatile.

The solvent front is the furthest distance travelled by the solvent.

Sometimes, the sample is separated into colourless spots. In this case the chromatography paper is sprayed with a locating agent to that locates the spots. The number of spots indicates the number of components in the sample.

To identify the substances which were formed when the sample was separated, we measure what's called the **R_f Value**. The R_f Value is the rate of the distance travelled by the solute (the spot) to the distance travelled by the solvent line. Its calculated by measuring the distance travelled by the spot (Distance₁) from the base line, measuring the distance from the base line to the solvent front (Distance₂), and dividing distance₁ by distance₂.

$$R_f \text{ value} = \frac{\text{Distance travelled by spot}}{\text{Distance travelled by the solvent}}$$

This value is always less than one because the distance travelled by the solvent is always larger than the distance travelled by the spot. Each substance has a different R_f Value.

Chromatography can be used to test purity of substances. If a substance gives only one spot, it means it is pure because it contains one substance.

If two spots have the same R_f value they are made of the same substance.

Chapter Three: Cell Structure and Organisation

A cell is the smallest unit that can carry on all the processes of life.

All organisms are made of cells, organisms are made of several organ systems, each organ system contains several organs, each organ contains several tissues, each tissue is made of cells. Cells are very tiny they could be seen only through a microscope. We have two types of cells:

CELLS

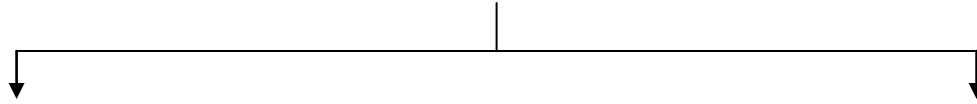

Plant Cells

Animal Cells

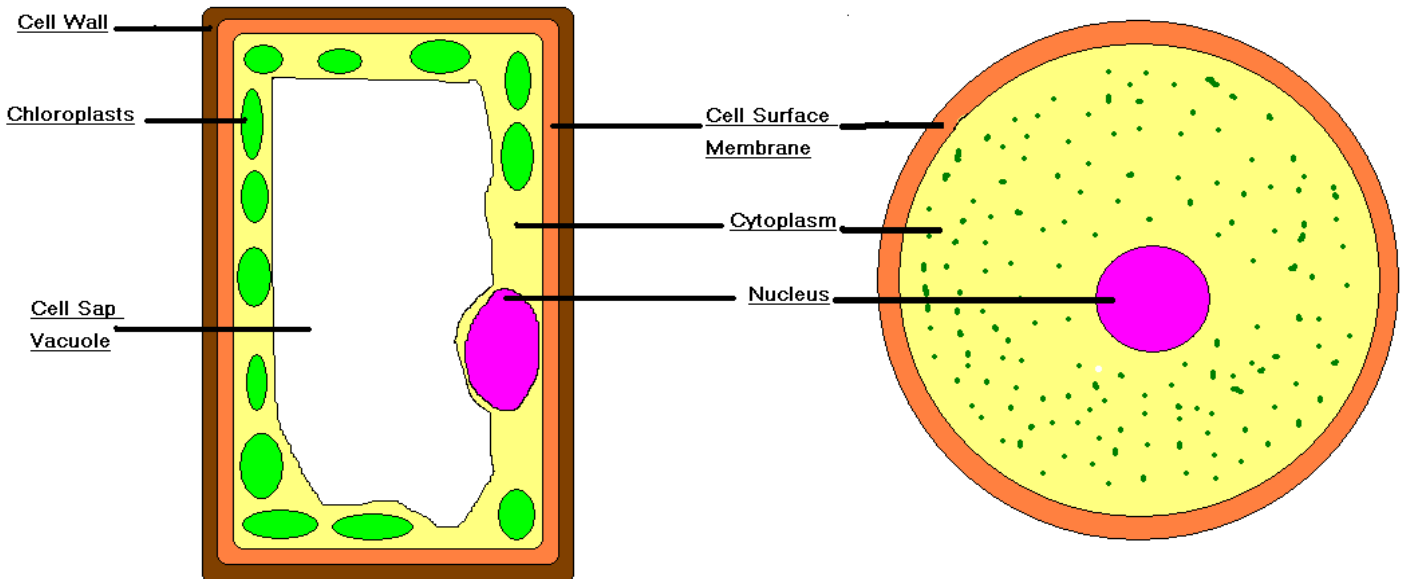

As you can see from the diagram, some features found in plant cells but not in animal cells.
Features found in both plant and animal cells:

- **Cell surface membrane:** This is a partially permeable membrane separating the cell from the environment its made of lipid and protein, it controls movement of substances in and out, its strong but flexible.
- **Cytoplasm:** This is a jelly like substance, its made of mostly water and protein. Metabolic reactions occur in it.
- **Nucleus:** This determines how the cell behaves and it contains chromosomes made of strings of DNA which also determines which proteins the cell should make etc.

Features found in only plant cells:

- **Cell Wall:** This is a rigid layer surrounding the cell made of cellulose, it gives the plant its shape and prevents it from bursting.
- **Chloroplasts:** They are sacs which contain chlorophyll which is a green pigment that traps sunlight for photosynthesis.

- **Vacuole:** This is a large room in the center of the cell, it stores sugars and salts and controls movement of water in and out of the cell.

Animal cells store sugars in glycogen form but plant cells store it as starch. Animal cells have an irregular shape but plant cells have a regular shape.

Both types of cells contain Mitochondria these are structures that convert chemical energy in foods to energy that could be used in moving, dividing, etc., it is evidence that the cell is an Active Cell.

Specialised Cells:

Red Blood Cells:

Red blood cells are found in the blood of animals, its function is to transport oxygen from the lungs to all the body cells, and carbon dioxide from the body cells to the lungs.



They are adapted by four ways:

- **They have a biconcave disc shape that gives it a large surface area to carry more oxygen.**
- **They contain a chemical called hemoglobin that combines with oxygen and carbon dioxide.**
- **They have no nucleuse to carry more oxygen and CO₂**
- **They are tiny enough to squeeze through capillaries.**

Muscle Cells:

They are cells found in muscles in animals, they contract and relax together to move the organisms. Their function is to contract to Support and move the body.

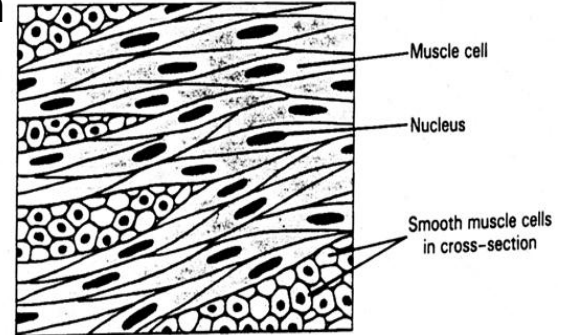

They are adapted by two ways, First, Is that they are made of contractile filament to help in contraction. Second is it contains lots of mitochondria to supply the cell with energy.

Ciliated Cells:

Ciliated cells are present in the trachea and bronchi of out respiratory system.

Their function is to use their cilia to sweep mucus up the trachea to the throat. The mucus traps bacteria and dust particles. When it reaches the throat, mucus is swallowed to the stomach where the acid kills the bacteria.

They are adapted by the tiny hair like projections called cilia which sweep the contaminated mucus upwards.

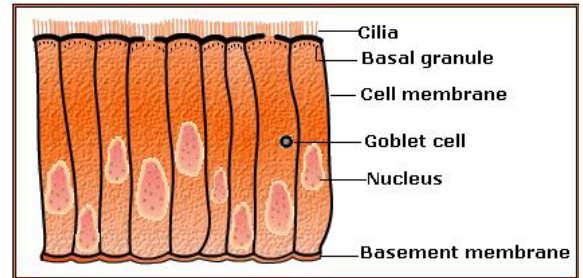

Ciliated epithelium

The mucus is secreted by goblet cells which are next to ciliated cells.

Root Hair Cells:

These are cells situated in the roots of plants. They contain no chloroplasts.

Their function is to absorb water and minerals from the soil. And to anchor the plant in the soil.

They are adapted by 3 ways. One, they have an extension that increases the surface area for more water intake. Two, they have a large number of mitochondria for respiration to become

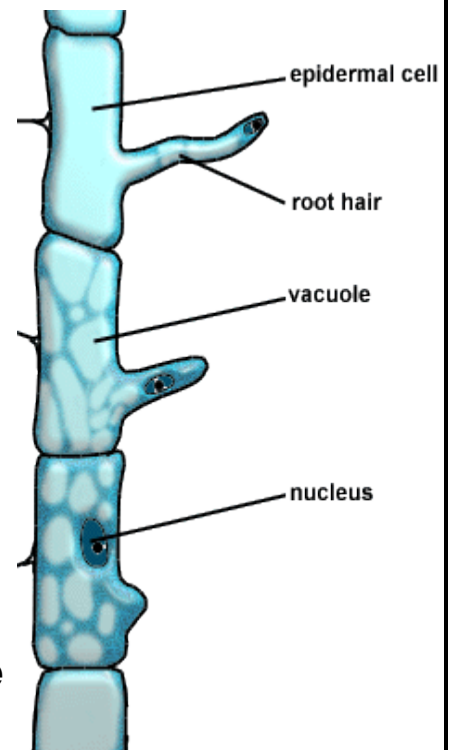

Vacuole to help absorbing water by osmosis.

Xylem Vessels:

These are dead lignified cells that exist in the stem of a plant.

Their function is to transport water and minerals from the roots to the leaves and the rest of the plant through the stem. And to support the plant.

They are adapted by 2 ways. Firstly, they are hollow to allow water and minerals to pass through them with no resistance. Secondly they are strong and lignified to support the plant.

The Division Of Labour: the specialization of cells to carry out particular functions in an organism.

Chapter Four: Movement In And Out Of Cells

Substance move in and out of cells by three ways:

- **Diffusion:** The net movement of particles from a region of their higher concentration to a region of their lower concentration down a concentration gradient, as a result of random movement.
- **Osmosis:** The diffusion of water molecules from a region of their higher concentration (dilute solution) to a region of their lower concentration (concentrated solution) through a partially permeable membrane.
- **Active Transport:** The movement of ions, in and out of a cell, through a cell membrane, from a region of their lower concentration to a region of their higher concentration, against the concentration gradient, using the energy released by respiration.

Diffusion:

Diffusion is the process by which oxygen enters the blood from the lungs, and by which carbon dioxide enters the leaf from the atmosphere. There are many more examples of diffusion in biology.

Diffusion always takes place down a concentration gradient, that means that the particles that diffuse try

to spread evenly in all spaces, so it moves from where it's very concentrated to where it's not concentrated.

There are some factors affecting the rate of diffusion, like the **steepness of the concentration gradient**. The steeper the gradient the faster the particles diffuse.

The surface area of the exchange membrane also affects the rate of diffusion. The larger the surface area of the exchange membrane the faster particles diffuse.

Thickness of exchange membrane too determines the diffusion rate, the thinner it is, the easier it will be for particles to go through it, the faster the diffusion rate.

Temperature is another factor affecting the diffusion rate, increasing the temperature will give particles more kinetic energy, making them move faster, thus increasing the rate of diffusion.

Osmosis:

Osmosis is the diffusion of water molecules. When we speak about osmosis, we don't say water concentration, instead we use the term **water potential**. A dilute solution means it has lots of water molecules, and a high water potential. A concentrated solution has few water molecules and low water

potential. Osmosis has to take place through a partially permeable membrane (or Semipermeable) this means that the Water molecules move from a place of their high concentration to a place of their low concentration through a membrane with pores in it that lets some molecules through but not others.

The diagram shows two solutions, one dilute And one concentrated, separated by A semipermeable membrane. Red circles Represent water molecules while blue circles Represent sugar molecules. The solution on The right is diluted while the concentration on The left is concentrated. The water molecules Will move from the right handside solution where they are very concentrated to the left handside solution where they are of a very low concentration, osmosis took place.

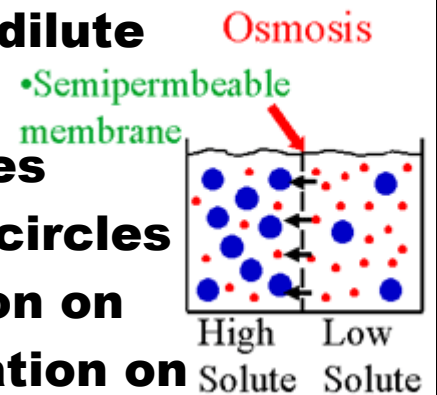

Osmosis happens all the time in cells. If you place an animal cell in distilled water. Osmosis will result in the water molecules moving from the distilled water where they are very concentrated to the Cell Where they are of low concentration Through the cell surface membrane. The cell becomes fat. As more Water molecules enter the cell, the cell will eventually burst and die.

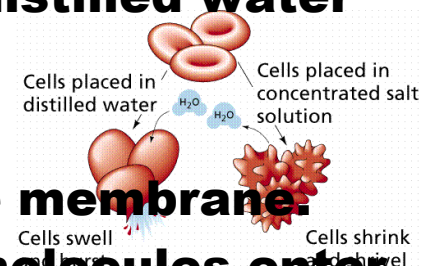

If we do the opposite, and place a red blood cell in a concentrated salt solution, the water in the cell has a higher water potential than the concentrated salt solution. Water molecules will move from the cell to the salt solution causing the cell to become shrunken and shrivel as in the diagram.

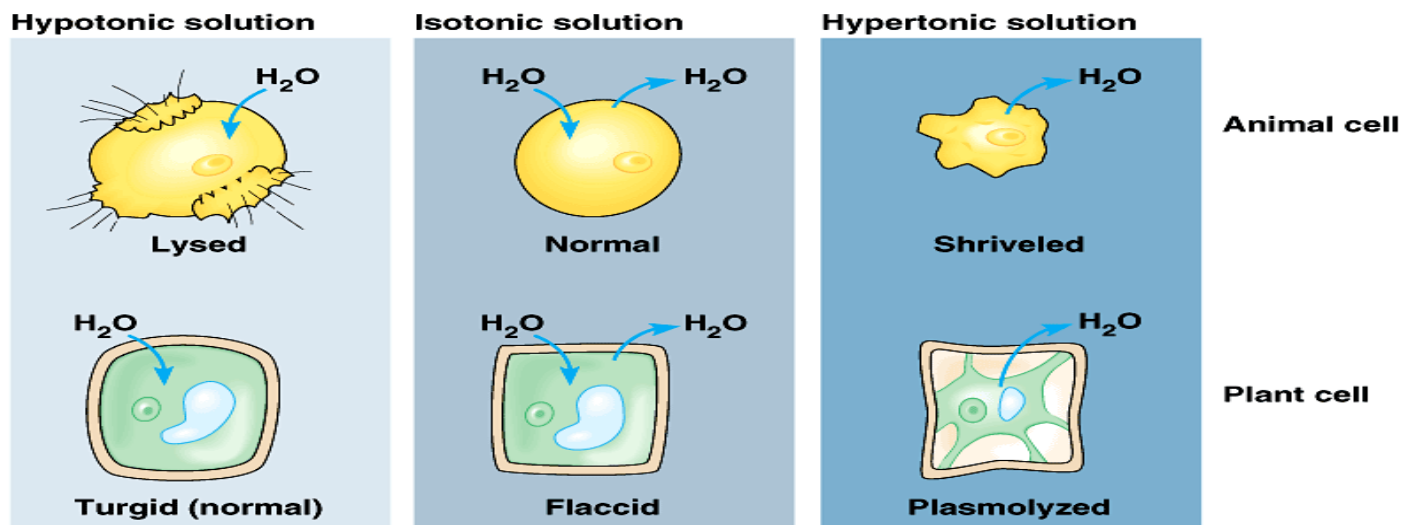

Copyright © Pearson Education, Inc., publishing as Benjamin Cummings.

In plant cells, if a plant cell is placed in distilled water, water molecules will move from the distilled water to the cell, the cell swells up and becomes turgid but it will never burst because plant cells are surrounded by cell walls, which are made of cellulose and is elastic, it will stretch but never break, the cell becomes turgid.

If we place a plant cell in a concentrated salt solution with low water potential, water will move from the cell to the solution causing the cell to become plasmolysed as in the diagram.

Active Transport:

Active transport occurs in cells, it is basically the movement of molecules or ions from a region of their low concentration to a region of their high concentration (against the concentration gradient) using energy of respiration. Active transport occurs in living, active cells only because it needs energy, these cells usually have a structure called mitochondria which respire producing energy to be used in active transport.

Active transport happens in roots to absorb mineral salts from the soil. It also occurs in the digestive system of mammals.

If oxygen is absent, respiration won't take place, active transport will stop. Molecules are taken into the cell by protein carriers within the cell membrane.

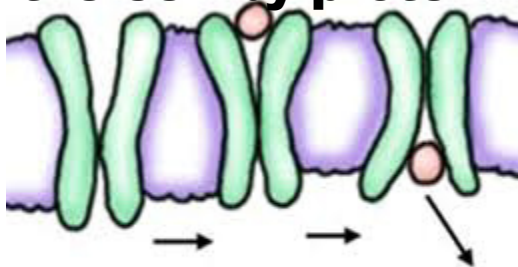

ONE METHOD OF TRANSPORT THROUGH THE MEMBRANE

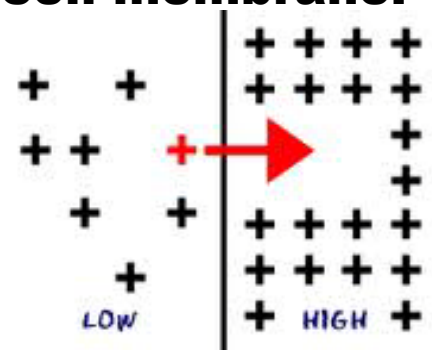

Chapter Five: Enzymes

What are enzymes?

Enzymes are proteins that function as a biological catalyst.

They are proteins in nature.

A catalyst is a substance that speeds up a chemical reaction but isn't changed by the reaction.

Hydrogen peroxide (H₂O₂) is a substance that decomposes into Water (H₂O) and Oxygen (O₂) if it is left in room temperature for a period of time. This reaction could a long time, but it could be sped up if we add a catalyst. Each catalyst can catalyse a specific substance and nothing but it. The catalyst for Hydrogen peroxide is called Manganese⁴ oxide. If it is added we will get water and oxygen gas in a very short time, and the manganese⁴ oxide could be obtained again as it was, it remains unchanged.

How Do Enzymes Work?

Enzymes work the same way as catalysts do, they can work with only one substrate and they can be used more than once.

Enzymes have a structure that is called active site. Only one substance can fit into the active site to be digested, and it is the only substrate that this particular enzyme works with.

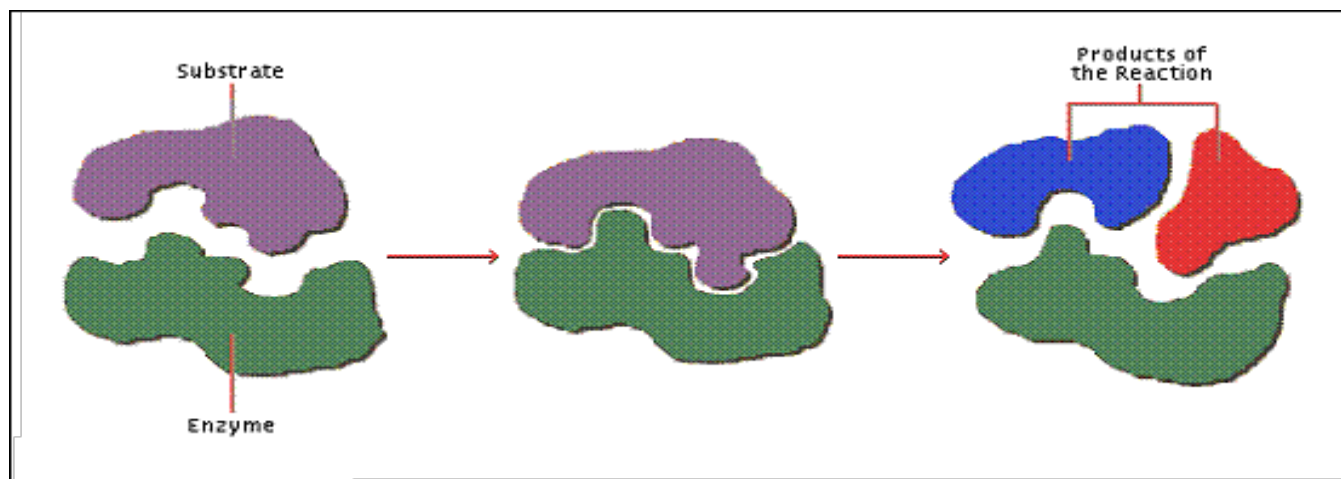

The figure above shows the function of enzymes:

- **The substrate enters the active site of the enzyme.**
- **The reaction takes place.**
- **The substrate exits the enzyme as two simpler products.**

You can also think of the way enzymes work as a key and a lock, the key is the substrate and the lock is the enzyme. The key should be exactly the right shape to fit in the lock, so does the substrate to fit in the active site of the enzyme. The key could only open only one lock, and the lock could be unlocked by only that key.

Enzymes are two types, Builders and Breakers.

Builder enzymes do the opposite of breaker enzymes. Breakers break large molecules into smaller simpler ones, builders combine smaller ones to make large molecules.

Breaker enzymes are used in the digestive system to break down large insoluble molecules into simpler soluble ones to be used by the body. They are also present in cells that respire to break down sugars and oxygen into carbon dioxide, water and energy. Builder enzymes are present in plants to be used in photosynthesis, the opposite of respiration, in photosynthesis, oxygen and water are combined together to form carbon dioxide and sugars.

Naming enzymes depends on the substrate they work on. For example:

The sucrase enzyme works on sucrose.

The maltase enzyme works on maltose.

Enzymes are reusable and are only affected by the change in temperature and pH.

Affect of temperature on the enzyme's activity:

Each enzyme has an optimum temperature, this is the temperature at which the enzyme is most active, below this temperature the activity of the enzyme decreases until it becomes inactive at low temperatures, above this optimum temperature the enzyme becomes denatured and can no longer work.

At low temperatures the enzyme is and the substrate are moving very slowly and collide weakly, the enzyme is said to be inactive and doesn't work. As the temperature increases, the enzyme and substrate gain more kinetic energy and move faster colliding more, the enzyme becomes more active and the reaction takes place. When the enzyme reaches it's optimum temperature, it is in its most active mood, if the temperature crosses the optimum the enzyme begins to die and become denatured. The enzymes become denatured when the shape of their active site changes as a result of high temperature, thus the substrate cannot fit into the active site and the enzyme is useless.

Each enzyme has its own optimum temperature, enzymes in humans have optimum temperatures of

around 40 degrees. Plants have enzymes with optimum temperature of about 25 degrees.

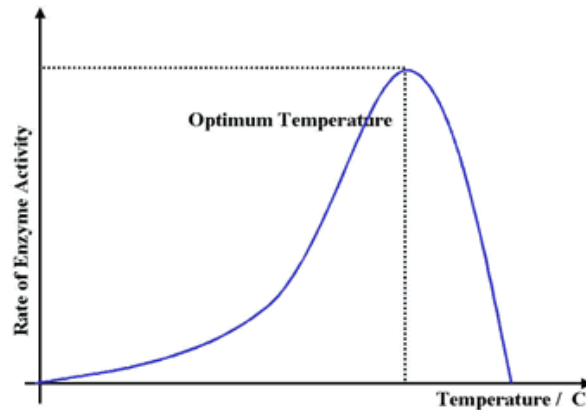

The Effect of pH on the enzyme's activity:

As in temperature, enzymes have an optimum pH. The pH is a scale measuring the acidity or alkalinity of a substance or solution. The scale runs from 1 to 14. pH 7 is neutral, below that it is acidic and above that it is alkaline.

Each enzyme has an optimum pH, if this pH changes, the shape of the active site of the enzyme is changed, thus the substrate will not be able to fit in it, and the enzyme becomes useless.

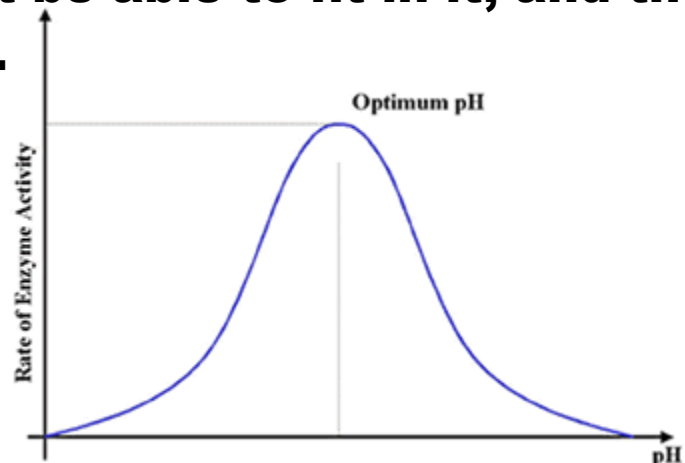

Uses Of Enzymes In Seeds Germination:

Seeds grow into plants by germinating. Seed germination involves enzymes breaking the materials stored in the seed down to be used in growth, energy and building cells. The seed contains stored substances such as:

***Starch:** Starch is broken down by amylase enzyme into maltose, maltose is then broken down by maltase enzyme into glucose which is used in respiration.

***Proteins:** Proteins are broken down into amino acids by Protease enzyme, amino acids are used in building up cells and growth.

***Fats:** Fats are broken down into fatty acids by lipase enzyme, they are used in making cell membranes.

In order for a seed to germinate, some conditions must be present:

- **Water:** To activate the enzymes.
- **Oxygen:** To be used for respiration.
- **Warm Temperature:** For providing the best conditions for enzymes to work and optimum temperature.

Uses Of Enzymes In Biological Washing Powders:

Washing powders contain detergents that help in cleaning clothes by dissolving stains in water. Some stains are made of insoluble substance, these cannot be removed by normal washing powders, instead, a biological washing powder is used.



Biological washing powders contain enzymes that break down the insoluble stain into smaller soluble substances, which are then dissolved in the water.

For example, if your shirt gets stained by egg yolk or blood, there is an enzyme called protease in the washing powder that will break down the insoluble protein into amino acids, which are dissolved in the water and sucked away. Thus the shirt becomes clean.

The best removal of stains is maintained by providing the optimum temperature for enzymes, presoaking to leave time for the enzymes to digest, putting the suitable amount of the powder.

Use Of Enzymes In Food Industry:

Enzymes are often used in the manufacturing of different foods.

Baking – Brewing – Cheese Making:

In baking, both yeast and sugar are Used. Yeast cells contain enzymes That ferment sugar by anaerobic Respiration producing carbon dioxide Bubbles which causes the dough to Rise as in the photo.



Brewing is the process of making wine or beer. In this process fermentation is Involved producing alcohol which and carbon dioxide that gives wine and beer its sparkle.

In making cheese, an enzyme called rennin extracted in enzymes, helps by clotting milk.

Making Juices:

In fruits such as apples or oranges, a substance called pectin holds the cells together making it hard to squeeze them. An enzyme called pectinase digests pectin making it much easier to squeeze the fruit and to make the juice more clear than cloudy.



Making Baby Foods:

It is hard for new born babies to digest food such as high protein foods. That is why foods like that are treated with proteases to break down protein to amino acids, making it easier for newborns to absorb and assimilate them.

Making Sugar:

Sugar producing companies get sugar from starch by using the amylase enzyme to digest starch into maltose. For dieters a sugar called fructose is very useful because it provides a sweeter taste than other sugars from a less quantity. Fructose can be obtained by using the isomerase enzyme to convert glucose to fructose.

Meat And Leather Production:

Proteases are used to make meat less tough and acceptable for consumers by treating cuts of meat.

In leather industries hairs are removed from animal skin by digesting them using protease enzymes.

The Enzymes used in the industries are taken from either fungi or bacteria. This takes place in a **Fermenter, this is a large sterilized container with a stirrer, a pipe to add feedstock and air pipes. The following steps take place:**

- **The micro-organisms and the feedstock are added and the liquid is maintained at 26 degrees and pH of 5-6.**
- **The micro-organisms produce two types of enzymes, either extra-cellular or intra-cellular.**
- **Extra-cellular enzymes are extracted from the feedstock by filtering.**
- **Intra-cellular enzymes are extracted by filtering the micro-organisms from the feedstock, crushing them, wash them with water then extracting them from the solution.**

Enzymes And Antibiotics:

Antibiotics are powerful medicines that fight bacterial infections. Micro-organisms are used for the production of antibiotics.

Some Antibiotics, like bactericides, fight bacteria by damaging its cell walls causing them to burst and die. Other antibiotics interfere with the protein synthesis and stop the bacteria growing.

Antibiotics have no effect on human cells because human cells have no cell walls and the structures involved in protein production are different than that of bacteria.

Antibiotics are obtained from sources like:

- **Bacteria (Actinobacterium Streptomyces):** this bacterium produces the antibiotic streptomycin.
- **Fungi (Penicillium fungus):** penicillin, the first antibiotic discovered is produced by this fungus.

Different types of penicillin are produced by different species of the fungus. They are chemically altered in lab to make them more effective and make them able to work with different diseases.

Steps of production:

- 1- The Fermenting tank is filled with nutrient solution of sugar (lactose) or corn liquor which contain sugars and amino acids**
- 2- Minerals are added**
- 3- pH is adjusted around 5 or 6**
- 4- Temperature is adjusted about 26 degrees**
- 5- The liquid is stirred and air is blown through it**
- 6- The micro-organisms are added and allowed to grow for a day or two in sterile conditions**

www.studyguide.pk
7- When the nutrient supply is decreased, micro-organisms secrete their antibiotics

8- The fluid containing the antibiotic is filtered off and the antibiotic is extracted,

Chapter 6: Nutrition

Nutrition is Taking in nutrients which are organic substances and mineral ions, containing raw materials and energy for growth and tissue repair, absorbing and assimilating them. Nutrition is one of the characteristics of living organisms. All organisms do it, they do it to obtain energy for vital activities and raw materials needed for growth and repair.

Every Individual needs to take In a certain amount of each Nutrient daily, depending on Their age, size, sex and activity.

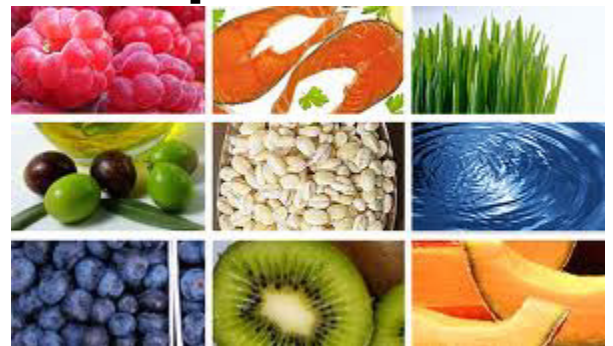

There are 7 Types of nutrients, these are:



Carbohydra tes



Proteins



Fa ts

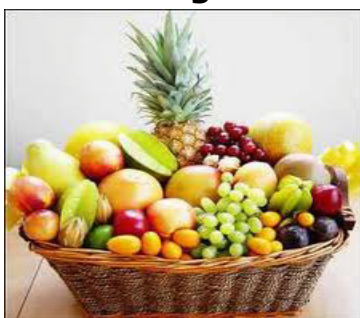

Vitamins



Minerals



Roughages



Water

Carbohydrates, proteins, fats and vitamins are all organic substances. This means that they are made by living organisms (plants) and contain carbon atoms in their structures. Plants make organic substances from inorganic materials like carbon dioxide, water and inorganic minerals. Animals are unable to do this.

*** Carbohydrates:**

This nutrient is an organic compound composed of carbon, hydrogen and oxygen.

Function: it is used as an energy resource, essential in respiration to release energy.

It is used in creating the cellulose, the substance forming cell walls of plant cells.

Carbohydrates are 3 types:

Monosaccharides: * The smallest and simplest form

* Water soluble

* Chemical formula $C_6H_{12}O_6$

* Examples: Glucose-Fructose-Galactose

* Sources: Fruits-Honey



Disaccharides:

- * Each molecule consists of two monosaccharide joined together
- * **Water soluble**
- * **Examples: Lactose-Sucrose-Maltose**
- * **Sources: Table sugar- Milk**

Monosaccharide and Disaccharides are sugars, they are reducing for Benedict's reagent, except for the disaccharide sucrose, it is non-reducing.

Polysaccharides:

- * Each molecule consists of many joined monosaccharide forming a long chain.
- * **Insoluble in water**
- * **Examples: Starch-Glycogen-Cellulose**
- * **Sources: Bread-Potatoes-Pasta**
Cellulose in plant cells
Glycogen in livers.

Polysaccharides are not considered as sugars and don't have a sweet taste. Excess polysaccharide are stores in the liver and muscles.

These are composed of carbon, hydrogen and oxygen. But their ratios are different than that of carbohydrates. One fat molecule is made of a glycerol unit and three molecules of fatty acids.

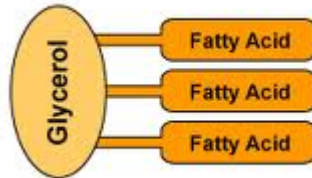

Types OF Lipids

Saturated Lipids
They are Solid
{eg: Butter}



Unsaturated Lipids
They are liquid
{eg: Oil}



Fats are essential in a diet because they are needed to:

- **Release high amounts of energy**
- **Make cell membranes**
- **Store them under the skin to insulate heat.**

- **Forming a layer of fats around organs to protect them from damage**
- **Storing energy (better than glycogen)**

When fats are respired, they produce about twice as much energy as carbohydrates.

***Proteins:**

These are also organic compounds, they contain the elements Carbon, Hydrogen, Oxygen, Nitrogen and sometimes Phosphorus or Sulfur.

A molecule of protein is a long chain of simpler units called amino acids.

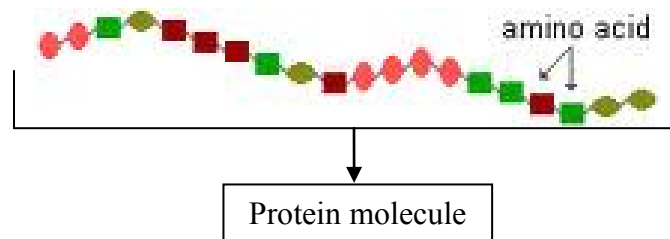

These amino acids are linked together by what's called "peptide bond".

Types Of Protein

Animal Protein

It contains the most biological value because it contains all essential amino acids. {eg: Meat, Milk, Fish, Eggs, etc.}



Plant Protein

It contains a lower biological value to humans because it contains fewer essential amino acids. {eg: Cereals, Peas, Beans, etc.}



Needs of proteins:

- Making and new body cells
- Growth and repair
- Making enzymes (they are proteins in nature)
- Build up hormones
- Making antibodies

Although proteins are needed in high amounts, the body will only absorb as much as needed, so excess protein is deaminated in the liver and excreted as urea.

These are organic, soluble substances that should be present in small amount in our diets, they are very important though.

Most of the amount of vitamins in our bodies was taken in as nutrients, the body its self can only make few Vitamins, so we have to have to get them from organisms that make them, such as plants.

Each type of Vitamin helps in chemical reactions that take place in our cells.



Types OF Vitamins

Vitamin C

This is present in most fruits and vegetables specially citrus fruits like lemon and oranges, however, it is damaged by heating so it these foods have no value of Vitamin C if they are eaten cooked. Vitamin C is essential for the formation of Collagen, a protein that functions as cementing layer between cells, Vitamin C also increases immunity.



Vitamin D

This is present in fish oils, egg yolk, milk and liver. Unlike Vitamin C, Vitamin D is made by animals as well as plants, this occurs when the skin is exposed to the Ultra Violet Rays of the sun. Vitamin D plays a big role in absorbing Calcium from the small intestine and depositing it in bones. So it is responsible for having healthy bones.



www.studyguide.pk
***Minerals (Inorganic Ions):**

These are a lot of types, each needed in small quantities. Iron and Calcium are the most important minerals, and they are needed in higher amounts.

Types Of Minerals

Calcium

This mineral is needed for the formation of bones and teeth as they are made of calcium salts, it also helps in blood clotting and transmission of nerve impulses. Good sources of the mineral Calcium are milk, dairy products and hard water.



Iron

This mineral is needed for the formation of the red pigment haemoglobin which is essential for the transport of oxygen around the body in red blood cells. Good sources of Iron include red meat specially liver and green leafy vegetables.



Although roughages are not even absorbed by the body, they are a very important nutrient in our diet. Roughages are mostly cellulose, which is the substance that makes up the cell walls of plants we eat. We humans, have no enzyme that could digest cellulose, that means that roughages enter the body from the mouth, go through the digestive system, and out through the anus unchanged. But as it goes through the digestive system, roughages take space in the gut to give the gut muscles something to push against, this process of pushing the food through the gut is called peristalsis, without roughages peristalsis is very slow and weak. Quick and strong peristalsis means that food stays in the alimentary canal for a shorter period, this prevents harmful chemicals of certain foods from changing the DNA of cells of the alimentary canal causing cancer, so roughages also helps stay away from cancer. Roughages are found in leafy vegetables.



About 70% of your weight is water. Water is perhaps a very essential nutrient we should take in. The functions of water include:

- **As a solvent which reactants of metabolic reactions are dissolved in.**
- **It makes up most of the blood plasma which red blood cells, nutrients, hormones and other materials are carried in.**
- **It helps in lowering the body temperature in hot conditions by secreting it as sweat on the skin, the sweat evaporates using heat energy from the body, thus lowering the temperature.**



A perfect diet contains all of the nutrients in reasonable proportions, not too much and not too little. The perfect diet should also contain energy as much as the total energy used by the individual.

The eatwell plate

Use the eatwell plate to help you get the balance right. It shows how much of what you eat should come from each food group.

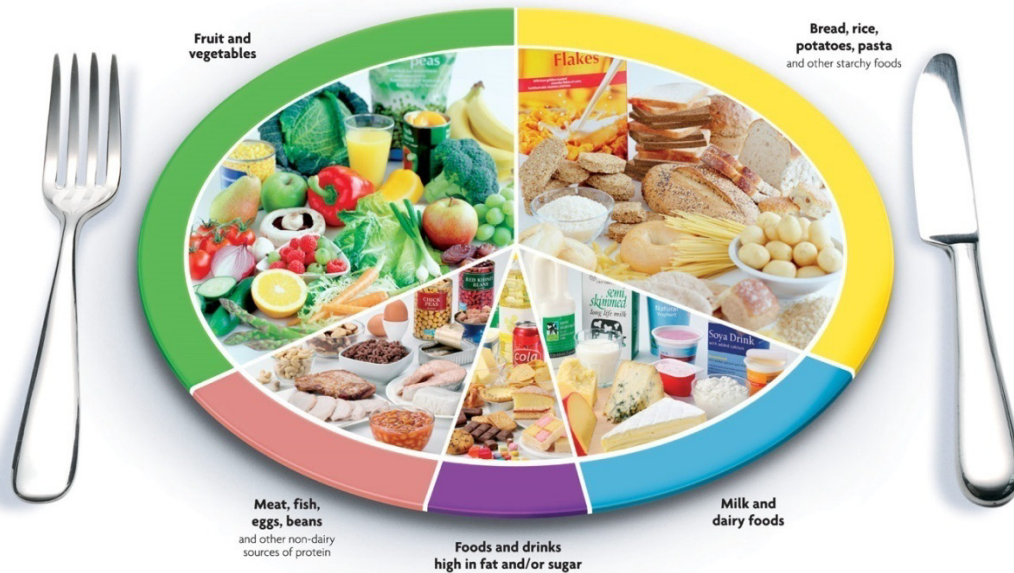

Malnutrition (Unbalanced Diet)

Malnutrition is eating inadequate proportions of food. In other words, an unbalanced diet means it is rich in a nutrient and low in another, or even lacking of a substance. There are lots of effects of malnutrition, such as starvation, obesity or deficiency diseases.

Starvation is an effect of malnutrition. In case of starvation the body tends to feed on its own self. When the glucose level is decreased in the body, the liver breaks down fats to respire for energy, when the body is out of fats, it starts respiring proteins from the muscles to release energy, eventually the body ends up looking like a skeleton. Starvation is usually present in countries with famines, which is caused by poverty, large population, low amounts of food, unsuitable climates and lack of money.



Obesity is the opposite of starvation. It is eating too much of every nutrient, especially carbohydrates and fats. Obesity doesn't strike alone, it brings with it several other diseases such as high blood pressure, cardiac diseases, diabetes, stress on joints and bones as well as other psychological issues like low self esteem and lack of confidence. To prevent obesity, you have to control your carbohydrates and fats intake and exercise regularly.



Another consequence of malnutrition is deficiency diseases. These are results of a certain nutrient in the diet.

Scurvy is the deficiency disease of vitamin C. Its symptoms include bleeding gums.

Rickets is the deficiency disease of both Vitamin D and Calcium. Bones are made of calcium which Vitamin D helps in depositing in the bones, if any of both is lacking in the diet, rickets is developed.

Anemia is the deficiency disease of iron. The amount of haemoglobin decreases causes short breath and tiredness.

Kwashiorkor affects children whose diets are lacking in protein. It causes weakness and tiredness.

Special Needs:

There are certain types of people whose diets need to be different to normal ones. Such as pregnant women, breast-feeding women or children going through puberty.

Pregnant Women:

The diet of a pregnant woman needs to be very rich of certain nutrients because she is not only feeding her self, she is feeding her baby as well. In order for the fetus to develop well, it needs extra Protein, Iron, Calcium and Vitamin D. Proteins are to develop the tissues of the fetus, Iron is to make haemoglobin and to store in the liver, while Calcium and Vitamin D are to develop the baby's bones.

Breast-Feeding Women (Lactation):

Lactation means the production of breast milk. After pregnancy, the mother breast-feeds the baby for about 6 months or more. Breast milk needs to be high in Proteins, Calcium, and Vitamins to guarantee a healthy growth for the infant.

Growing Children (Passing Puberty)

At some point, each child gets a growing spurt. This is a very high growth rate that increases the child's size and mass in a short period of time. A growing child's diet needs extra Proteins to develop cells and enzymes because their metabolic rate is higher, Calcium and Vitamin D to develop bones and Iron to make haemoglobin.

These are chemical compounds added to foods by the manufacturer because they have some benefits such as increasing the lifespan, prevent rotting etc. Most food additives are good, such as ones that add colours or flavours to foods. But there are others which have been proven hazardous to humans.

Good food additives include flavourings and colourings which are used to make the food more appealing, antioxidants which prevent foods from combining with oxygen and rot, and stabilisers which stops foods like ice-cream from separating into water and fatty components.

Food preservatives though, are a widely used food additives which increase the lifespan of foods, making it cheaper to store and transport. However, scientists claim that some preservatives contain nitrites which combine with chemicals making a substance (nitrosamines) that causes cancer in animals.

Food Additives**Advantages**

- Prevents rotting
- Improve colour
- Improve flavour
- Keeps texture
- Increases lifespan
- Prevents poisoning

disadvantages

- Allergic reactions
- Cause hyperactivity
- Damages liver/kidney
- Carcinogenic
- Makes bad food look good

Microorganisms And Food Industry:**Production of Single Celled Protein (Mycoprotein):**

Mycoprotein is a protein made from microscopic fungus. Humans need large amounts of proteins in their diets, in some poor areas, sources of proteins like meat are unaffordable, mycoprotein is used.

The process takes place in a sterilised container called fermenter. The micro-organisms are grown in the fermenter and supplied with **air which contains oxygen for aerobic respiration, **ammonia** as a source of nitrogen to be used by the micro-organisms to make proteins, and **methanol** which contains carbon for the formation of carbohydrates.**

Advantages of mycoproteins are that it is cheaper than any source of protein but equal in value, and that it contains much less fats and more roughages and carbohydrates

Production OF Yoghurt:

- **Milk is sterilised by boiling**
- **Certain types Bacteria are added to the milk**
- **The milk is kept warm to provide best conditions for bacteria growing**
- **Bacteria respire producing lactic acid, thickening the milk and giving it the pleasant flavour**
- **Yoghurt is cooled and flavours or fruits could be added.**

Food Tests:

Starch Test:

- **Put sample in a test tube**
- **Add water to make it a solution**
- **Add iodine solution**
- **Is starch is present the solution changes colour from yellowish brown to Blue Black.**
- **If starch is not present the solution remains yellowish brown.**

Reducing sugars (carbohydrates) test:

Note: This test is only applicable on all sugars (monosaccharide and disaccharide) EXCEPT FOR SUCROSE.

- **Add sample to a test tube**
- **Add **Benedict's Reagent****
- **Put test tube in water bath for heating**
- **If reducing sugars are present the solution turns from blue to **yellow, orange, red** (fire colours)**
- **If reducing sugars are not present the solution remains blue.**

Proteins Test:

- **Put sample in a test tube**
- **Add water to make a solution**
- **Add **Buired Reagent****
- **If proteins are present in the solution turns **Purple****
- **If proteins are not present the solution remains blue.**

Note: Biuret Reagent is blue in colour and made of copper sulphate and a small amount of sodium hydroxide.

Fats Test:

- **Add sample to a test tube**
- **Add ethanol**
- **Add water and shake well**
- **If fats are present the solution becomes unclear**
- **If fats are not present the solution remains clear**

General Table:

| Nutrient | Test | Colour | Positive | Negative |
|-----------------|-----------------------|---------------------|-------------------|---------------------|
| Starch | Iodine sol. | yellow/brown | Blue/black | yellow/brown |
| Carbs | Benedict's | Blue | Red (fire) | Blue |
| Proteins | Biuret reagent | Blue | Purple | Blue |
| Fats | Ethanol/water | - | cloudy | clear |

Chapter 7: Animal Nutrition

Animals eat to grow, repair etc. They simply eat to live. In this unit we will study how animals make use of what they eat. The journey of the food from the mouth to the anus through the alimentary canal includes 5 steps:

Ingestion: Taking in pieces of food into the mouth

Digestion: The break down of large, insoluble food molecules into smaller more soluble ones by chemical and mechanical means.

Absorption: Taking the digested food molecules into the cells

Assimilation: Making use of the digested food molecules for example to release energy or grow etc.

Egestion: The elimination of undigested food materials through the anus

*** Don't confuse egestion with excretion, excretion is to get rid of waste products of metabolism.**

The alimentary canal (gut or digestive tract) is made up of several organs working together to perform all the processes mentioned above. Starting with the mouth and ending with the anus.

Organs of the Digestive System

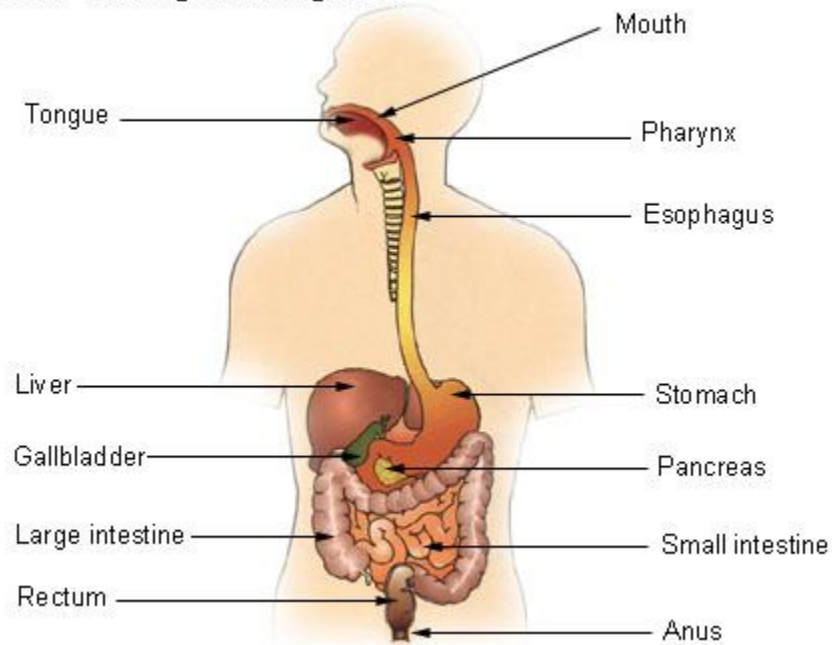

The journey of the food inside the human body:

The Mouth:

The mouth performs several functions.

Mechanical Digestion: The action of the teeth biting a small piece of food from a large one is considered

Mechanical digestion, the teeth also tear and grind the food into a bolus to give it larger surface area for faster chemical digestion.



Chemical Digestion: beneath the tongue lies a salivary gland which secretes saliva into the mouth, this saliva contains water and mucus to lubricate the food bolus and amylase enzyme that breaks down starch in the food into maltose.

After this the tongue pushes the food bolus into the oesophagus.

The Oesophagus:

This is a tube that transports the food from the mouth deep into the body to the stomach.

The food is pushed downwards by the muscles in the walls of the Oesophagus, this process is called

Peristalsis. Muscles contract and relax creating a wavy motion to push the food down.

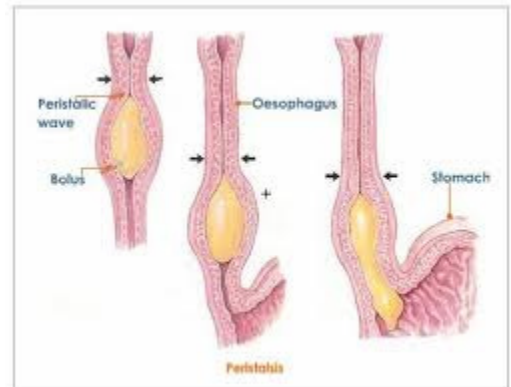

The Stomach:

Here the food stays for a while. The stomach is a flexible bag that performs both mechanical and chemical digestion.

Mechanical digestion: The walls of the stomach contain muscles that contract and relax together

mixing the food with the content of the stomach and turning it into liquid chyme, this process is called churning.

Chemical digestion: The walls of the stomach also secrete a liquid called “**Gastric Juice**” which contains **Hydrochloric acid, Mucus, and pepsin enzyme**. The pepsin enzyme digests proteins into simpler polypeptides, while the hydrochloric acid is to provide optimum pH for the enzyme and the mucus is to lubricate the food and protect the walls of the stomach from the acid.

After few hours, the sphincter which is a muscular valve opens allowing the food into the small intestine.

The Small Intestine:

The small intestine is where most digestion and absorption takes place. It is divided into two sections, duodenum and ileum. The walls of the small intestine contains several types of liquids that help in providing suitable conditions and digest the food. These liquids are:

Bile Juice: It comes from the liver, stored in the gall bladder. It is squirted along the bile duct in the duodenum. The bile works on fats only, fats are very difficult to digest because they are very insoluble, the bile contains bile salts that breaks fats into tiny droplets that float in the content of the small intestine, making it easier for the lipase to digest fats into fatty acids and glycerol, this process is called emulsification.

Pancreatic Juice: it comes from the pancreas and secreted along the pancreatic duct. It contains enzymes and sodium hydrogencarbonate, which neutralises the hydrochloric acid that was added to the food in the stomach, creating better conditions for the enzymes to work. The pancreatic juice contains the following enzymes:

- **Amylase** to digest starch into Maltose
- **Trypsin** to digest proteins to polypeptides
- **Lipase** to digest fats into fatty acids and glycerol

Small intestine liquid: the small intestine its self also secrets a liquid that consists of lots of enzymes to make sure carbohydrates, fats and proteins are digested to their simplest form, these enzymes are:

For carbohydrates:

- **Maltase** to digest maltose into glucose + glucose
- **Sucrase** to digest sucrose into glucose + fructose
- **Lactase** to digest lactose into glucose + galactose

For Fats:

- **Lipase** to digest fats into fatty acids and glycerol

For proteins:

- **Protease** for further digestion of polypeptides to amino acids.

Absorption in small intestine:

Absorption in the small intestine takes place in the second section, the ileum. The walls of the ileum are fully adapted for absorption. The interior walls of the ileum is covered with a layer of villi, each villus is covered with another layer of micro villi.

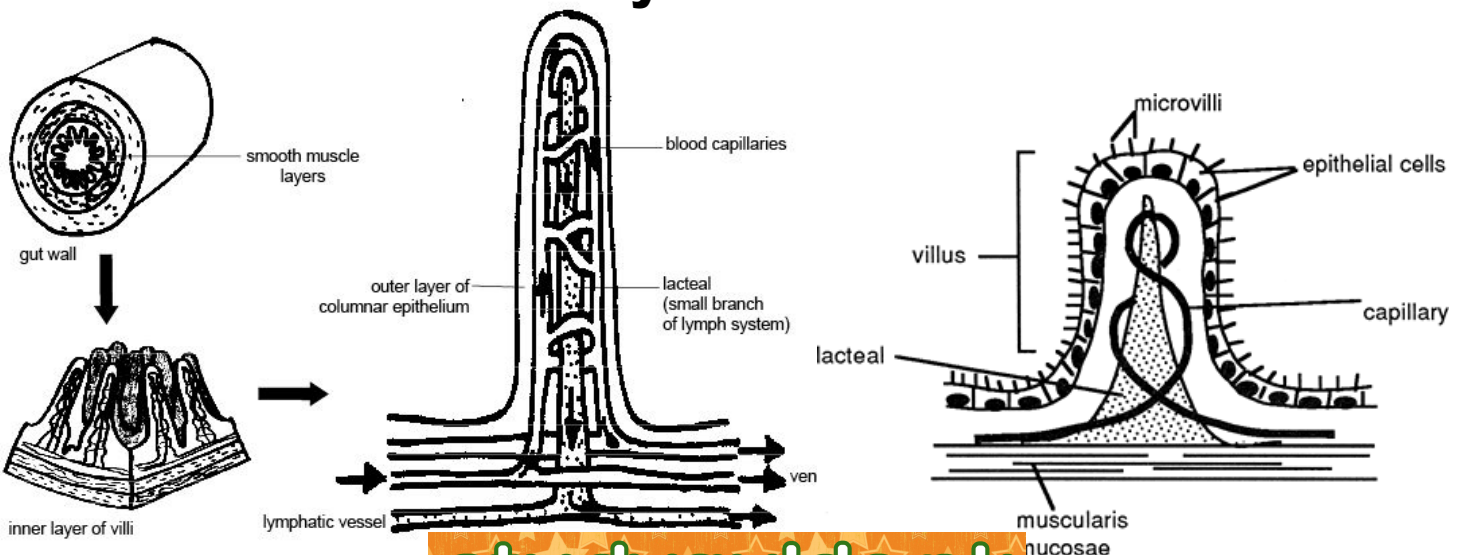

Each villi has a branch of blood capillaries in it as well as a lacteal. Which is a lymph vessel, the lacteal absorbs fats and lipids with vitamins dissolved in them into the lymphatic system.

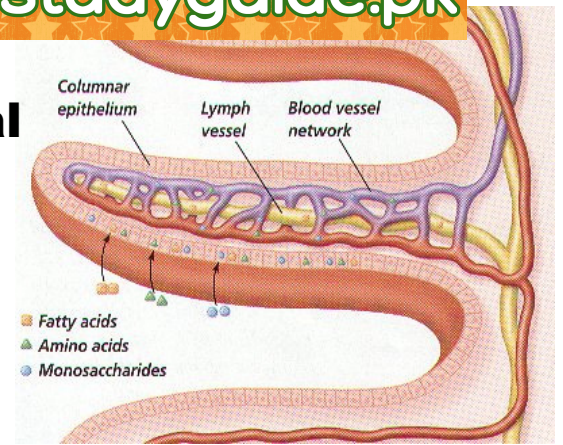

Villi and microvilli are adapted to absorption by:

- **They give a very large surface area for faster diffusion of food molecules**
- **Each villus contains a large network of blood capillaries transporting more blood, thus faster diffusion**
- **Each villus is one cell thick, reducing the diffusion distance and making it faster**
- **Each villus contains a lacteal which absorbs fats**

The Large Intestine:

By the time the food reaches the large intestine, there is not much left of it, only some water, minerals, and fibers. The water and the minerals are absorbed into the blood, while the fibers and dead cells of the

alimentary canal are stored in the **rectum** then excreted through the **anus** (**egestion**).

Assimilation Of The Absorbed Food Molecules:

After the food molecules are Absorbed from the alimentary canal, It is transported to the liver by a Special blood vessel called

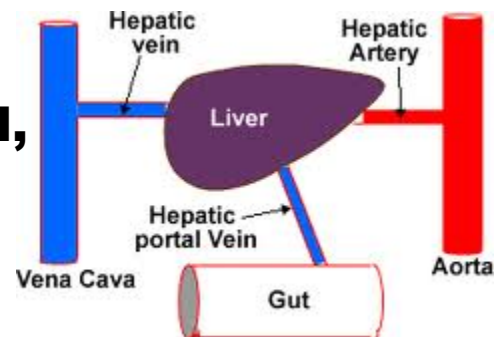

The Hepatic Portal Vein. The liver is an organ that is considered a gland too. It carries out several jobs to “sort out” the food molecules it receives. Each type of nutrient has its own fate in the liver.

Glucose: when the absorbed glucose reaches the liver, the liver allows as much as needed by the body to pass to the circulatory system to be used for respiration or other processes. The excess glucose is converted to glycogen and stored in the liver cells, when the blood is short in glucose, glycogen will be converted back into glucose and secreted to the blood. Some glucose will also be converted to fats as an energy reserve. These functions are controlled by the Insulin and Glucagon hormones which are made in the pancreas.

Amino Acids: some amino acids will be used by the liver cells to make proteins, the rest will be allowed into the blood stream to be absorbed by the body cells which also convert it to proteins. If the body contains enough amino acids, the excess will undergo a process called **Deamination**, this involves the break down of amino acids into carbohydrates and amino group, which is then converted to ammonia then converted into urea, which is part of the waste product of the body, urine.

A part from sorting out food molecules, the liver performs the following jobs too:

- **Dealing with old red blood cells:**

The liver changes dead red blood cells to iron and bile. Iron is stored in the liver, large amounts of iron give it the red colour and used to build up new red blood cells. The bile is stored in the gall bladder to be used in digesting food again.

- **Detoxification:**

The liver breaks down toxic materials such as alcohol which damages cells to fats. Alcoholics are known to have liver diseases.

www.studyguide.pk

- **Helps in generating heat:**

The liver contains a very large number of cells, which means a lot of metabolic reactions take place in it producing lots of energy to warm the blood.

- **Making fibrinogen:**

This is a plasma protein which helps in blood clotting when the skin is cut.

Teeth:

Teeth are made of calcium salts.

Their job is to cut, tear and grind food

To give it more surface area for faster

Digestion, they do mechanical digestion.

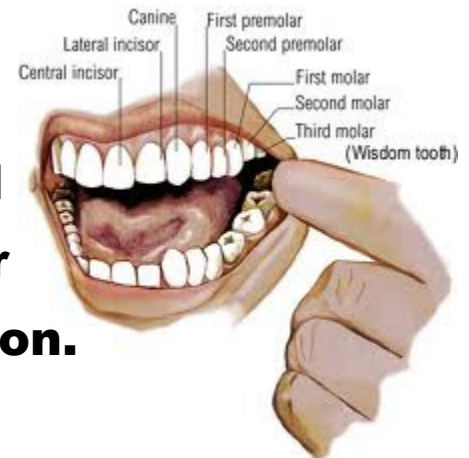

Types of mammalian teeth:

- **Incisors:** they are 4 in front of each jaw.

They act like a blade to cut food

(eg. To cut a bite of a sandwich) they

have a (chisel-like surface).

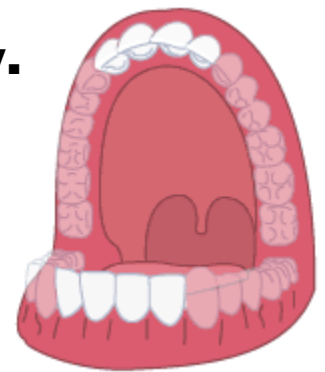

- www.studyguide.pk
- **Canines:** they are two in each jaw.

**They are very pointed, in humans
They are used for the same purpose
As incisors. However in carnivores
They are longer and sharper and
Used to kill the prey.**



- **Premolars:** 4 on the sides of each jaw
They are used to cut and grind food



- **Molars:** they are 6 at the back of
Each jaw, 2 of them are wisdom
Teeth. They have the same use as
Premolars.



Note: remember that we have two jaws, so 4 incisors in each jaw means that we have a total of 8 incisors in our mouth. We have 16 teeth in each jaw, 32 in the whole mouth.

The tooth is divided into two parts, the crown and the root.

Parts of the tooth:

Enamel: made of calcium Salts, it is very strong.

Dentine: it is covered by The enamel and surrounds The pulp cavity.

The pulp cavity: it contains the nerves and blood vessels.

The part of the tooth above the gum is called the crown, the part buried in the jawbone is called the root. The enamel covers the crown, the root is covered by cement. And the tooth is held in place by fibres.

Tooth Decay: when we eat, some food particles stay in our mouth. Bacteria that lives in our mouth feed on these food particles, they respire anaerobically producing lactic acid. Like any acid, lactic acid reacts with the enamel and dissolves it away reaching the dentine, here we feel the toothache.

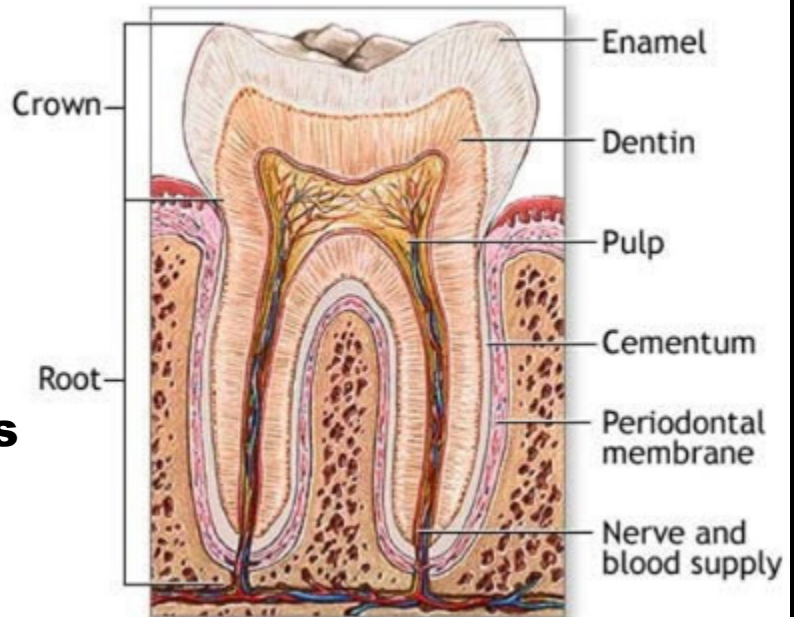

Methods Of preventing Tooth Decay:

- **Reduce sugar intake to prevent bacteria respiring**
- **Brush teeth to remove the plaque layer of bacteria and saliva on our teeth and neutralise mouth**
- **Use toothpaste or water containing fluoride because it is absorbed by the teeth and helps stopping the attack by acid**
- **Pay regular visits to the dentist.**

Adding Fluoride To Water

Advantages

- **Suitable amounts prevent tooth decay**
- **It is a cheaper method of teeth caring**

Disadvantages

- **Too much causes teeth molting, illness and abdominal pain**
- **It is expensive**



Decayed Teeth

Chapter 8: Transport In Humans:

The human transport system is a system of tubes with a pump and valves to ensure one way blood flow. We need a transport system to deliver oxygen, nutrients and other substances to all our body cells, and take away waste products from them.

How It Works:

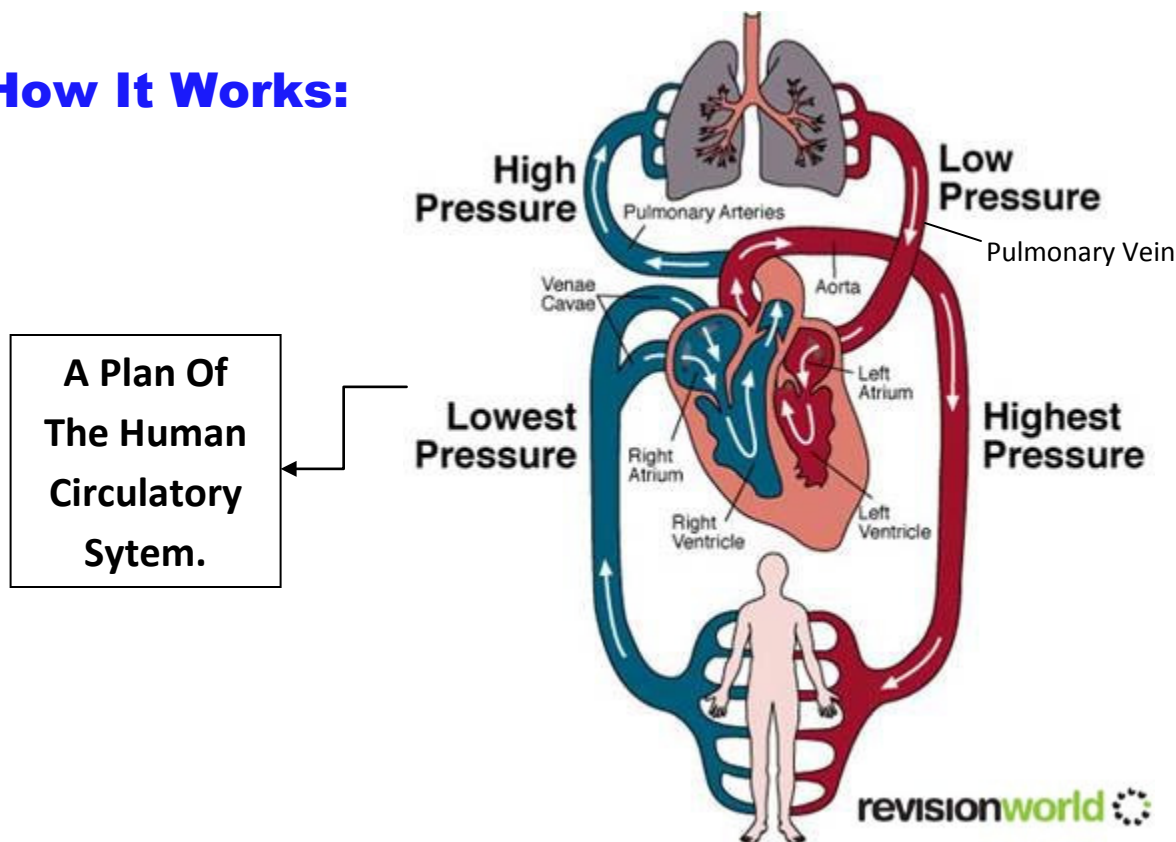

The oxygenated blood (high in oxygen, red in colour) comes to the heart from the lungs in the pulmonary vein, the heart pumps it to the aorta (an artery) to the rest of the body. The deoxygenated blood returns to the heart from the body in the vena cava (a vein), the heart pumps is to the lungs to get rid of the carbon dioxide

Oxygenated Blood → red colour, high oxygen low carbon dioxide

Deoxygenated Blood → blue colour, low oxygen high carbon dioxide

Did you notice that during one circulation, the blood went through the heart twice, this is why we call it **double circulation**. When the blood is flowing away from the heart, it has a very high pressure, when it is flowing towards the heart it has a lower pressure.

The Blood:

The blood is a fluid consisting of several types of cells floating in a liquid called plasma.

Red Blood Cells:

These are one of the smallest cells in Your body, they are round with a dent in The middle, we call this shape a **Biconcave disc**.

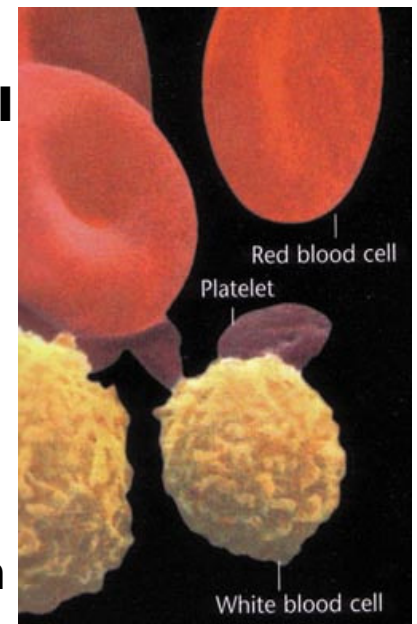

Blood Under A
Microscope

The function of the red blood cells is to transport oxygen from the lungs to the body cells. A red protein called Haemoglobin, when the blood reaches the

lungs, oxygen diffuses from the alveoli to the red blood cells and combines with haemoglobin forming an unstable compound called oxyhaemoglobin. When the blood reaches the body cells, the oxyhaemoglobin is easily split into oxygen and haemoglobin again, the oxygen diffuses through the blood plasma to the cells.



Red blood cells are fully adapted to their function by the following characteristics:

- **Biconcave disc shape gives it large surface area to carry more oxygen**
- **Haemoglobin to combine with oxygen**
- **No nucleus that takes up space.**

White Blood Cells:

White blood cells are one of the substances floating in the blood plasma. They are completely different in function than red blood cells. White blood cells are part of the Immune System, they play a big role in protecting the body by killing bacteria which cause disease, also known as pathogens. White blood cells can be distinguished from red blood cells easily

because they are much bigger, with a nucleus, and present in fewer amounts.

Types OF White Blood Cells

Phagocytes

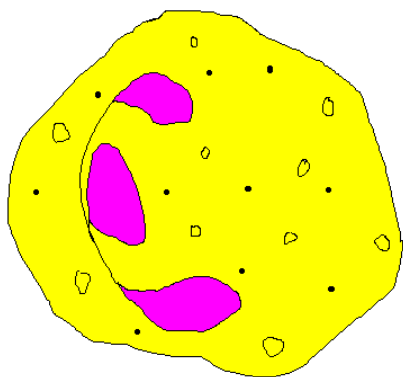

They kill bacteria by engulfing them, taking them in the cell then kill them by digesting them using enzymes, this process is called **phagocytosis**.

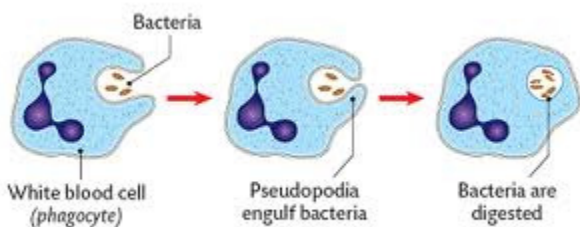

Most white blood cells are the phagocyte type.

Lymphocytes

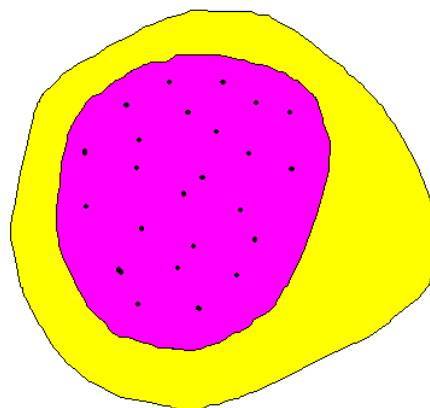

Unlike phagocytes, lymphocytes have a large nucleus. They are produced in the lymph nodes (in the lymphatic system). Lymphocytes kill bacteria by secreting antibodies and antitoxins which kill the pathogens directly or make them easier to kill. Each pathogen could be killed by a certain type of antibody

Platelets are tiny cell fragments that prevent bleeding when the skin is cut, and stops bacteria from entering our systems through the wound. This works by blood clotting, when the skin is cut, some reactions take place that results in platelets producing a protein, this protein will change the fibrinogen (another soluble protein in the plasma) to insoluble fibrin. The fibrin forms long fibres that clot together blocking the cut, thus preventing any bleeding, this is called blood clotting.

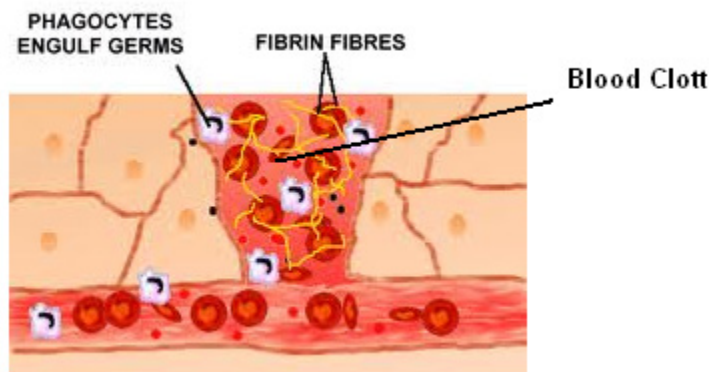

Blood Plasma:

This makes up most of the blood. It is mostly water with some substances dissolved in it, these include carbon dioxide, hormones, food nutrients, urea and other waste products. The blood plasma transports substances from one place to another.

- **Transportation of R.B.C's, W.B.C's, oxygen, food nutrients, hormones, and waste products.**
- **Defence against disease, by white blood cells phagocytosis and production of antibodies.**
- **Supplying cells with glucose to respire and keep a constant temperature.**

Blood Vessels (Vascular System):

This is a number tubes carrying blood away from and to the heart and other organs. The main types are Arteries, Veins and Capillaries.

Arteries:

Their function is to transport Blood away from the heart to the Lungs or other body organs.

The blood in the arteries always Has a high pressure. The heart pumps the blood Quickly into the arteries, resulting in the pressure, each time the ventricle of the heart contracts, the pressure in arteries increase, when the ventricle relaxes, the pressure falls. The lumen of arteries is also very narrow adding to the pressure.

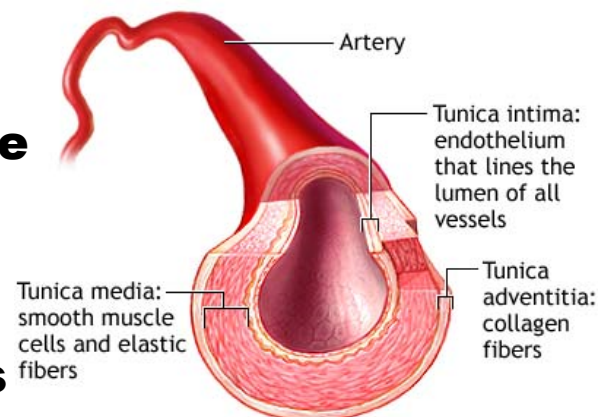

ADAM.

The structure is simple, beside the narrow lumen, the arteries have a strong thick wall to withstand the pressure. Their walls are also elastic and stretchable.

Brief description of characteristics of arteries:

- Transporting blood away from the heart
- Always in a high pressure
- Strong but stretchable walls
- Narrow lumen.

Veins:

Their function is to Transport blood to The heart from the Body.

The veins always
Always have a low

Blood pressure because by the time the blood with high pressure reaches the veins, it loses most of the pressure. This means that blood flows very slowly in veins, to help this, veins lie between muscles so that the blood is squeezed when the muscles contract.

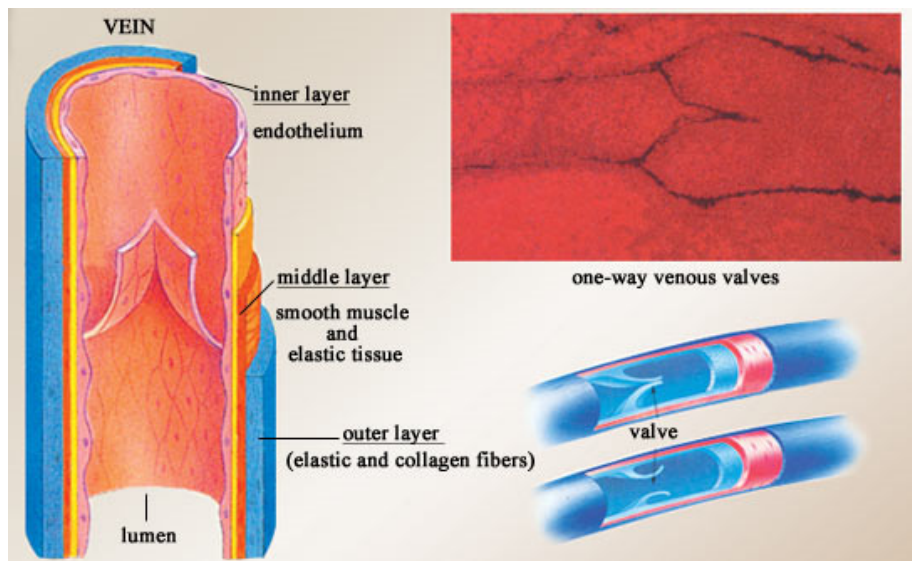

They have a simple structure. Because they have a low pressure, they don't need strong, thick walls like the artery, instead they have thin less elastic walls. Their lumen is much wider too. Veins have a unique feature, that is valves. Because blood in veins flows slowly with a low pressure, there is a risk of a backflow, specially in veins that move blood upwards against gravity, like the ones in the leg. The valves ensure that the blood is always flowing in the direction of the heart. When the muscles squeeze the blood, the valves are open the let blood through, when muscles relax, valves close to prevent a backflow.

Brief description of characteristics of veins:

- **They carry blood to the heart**
- **Always in a low pressure**
- **Thin less elastic walls**
- **Wide lumen**
- **Valves present.**

| Arteries | Veins |
|--|--|
| • blood flows away from the heart | • blood flows towards the heart |
| • possess thick elastic walls | • possess thin, not very elastic walls |
| • carry oxygenated blood except pulmonary arteries | • carry deoxygenated blood except pulmonary vein |
| • do not possess valves except in the aorta | • have valves to prevent back-flow of blood |
| • arteries are deeper in the flesh than veins | • veins are nearer the surface of the skin than arteries |
| • pulse is detectable | • pulse is usually not detectable |
| • have narrow lumen | • have wider lumen |

Table that compares arteries and veins

Blood capillaries are the smallest Blood vessels in our systems. Their Function is to get blood from the Arteries as close as possible to the tissues in order to exchange materials with the cells, and to link arteries with veins.

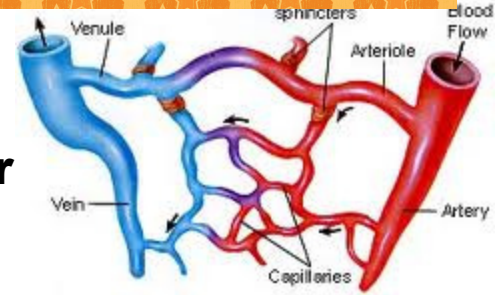

When arteries come near and organ or a tissue, it divides into arterioles, these arterioles divide more into several blood capillaries that go through the tissue, this is when the exchange of oxygen and food nutrients with carbon dioxide and waste products such as urea take place by diffusion.

Blood capillaries are very well Adapted to their jobs. They are One cell thick to reduce the diffusion Distance of materials for faster diffusion. They Also have pores in their walls between the cells, to allow the plasma to get out of the blood and become tissue fluid.

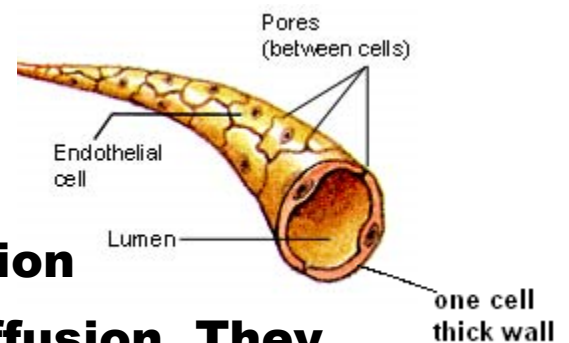

The Heart:

The heart is a pumping organ that is Responsible for the movement of blood Around the body. The function of the Heart is to give the blood a push, Keeping it flowing around the body all The time. That is why the heart is Constantly working, if it stops for a Minute, the other organs will not receive any oxygen or nutrients, thus the body fails and the person dies. The heart is located in the chest, the thoracic cavity between both lungs.

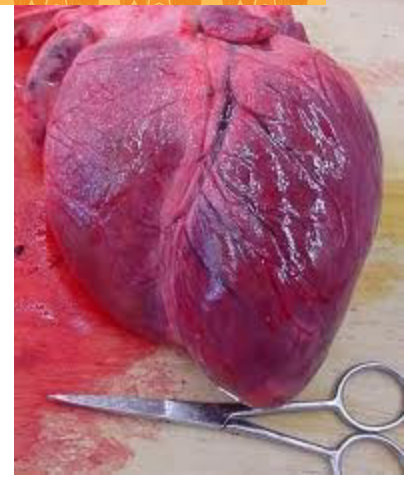

A Real Human Heart

Structure:

The heart is hollow, it has 4 chambers. Two of them are atria and two are ventricles. One of each of these on each side. When looking at the diagram of a heart, notice that your right is the left side of the heart, and your left is the heart's right, as if you are looking at your own heart on a mirror.

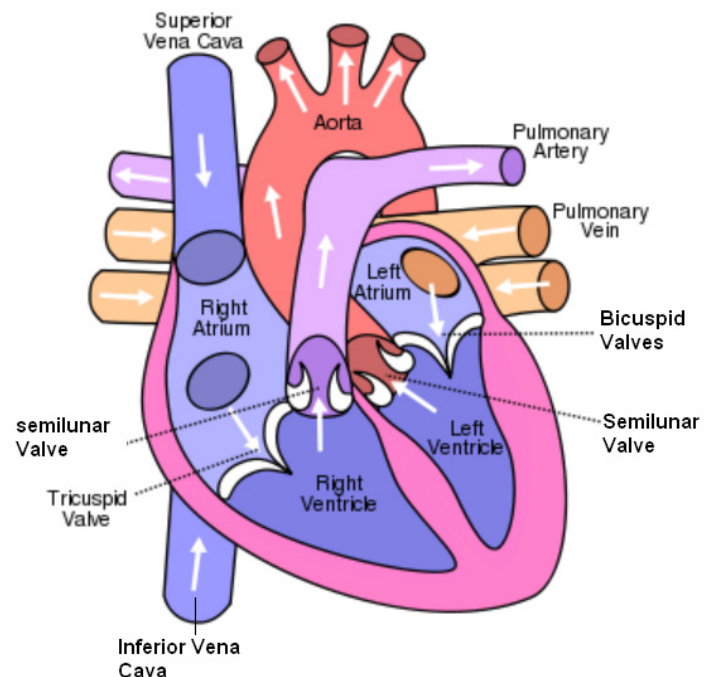

The sides of the heart are separated by a wall called septum. Each side contains an atrium (at the top) and a ventricle (at the bottom), there is a valve between the atrium and the ventricle in each side, it is called bicuspid valve in the left side and tricuspid valve in the right side. There several blood vessels associated with the heart, these are:

- **The Pulmonary vein, it transports oxygenated blood from the lungs to the right atrium.**
- **The Aorta, which is the biggest artery in the body, it transports oxygenated blood from the heart to the rest of the body.**
- **The Vena Cava, the biggest vein in the body, it transports deoxygenated blood from the whole body to the heart.**
- **The pulmonary artery, it transports deoxygenated blood from the heart to the lungs.**

Note that blood vessels entering the heart are veins, and the ones leaving the heart are arteries. The left side of the heart always contains oxygenated blood because it receives blood fresh from the lungs and pumps it to the body, the right side always contains deoxygenated blood because it receives is from the body. You can memorise this by the word **LORD:**

Left Oxygenated – Right Deoxygenated

The diagram on the right represents the blood flow, the heart receives blood from the lungs at the left atrium and pumps it to the body from the left ventricle, then it receives it again from the body at the right atrium and pumps it to the lungs from the right ventricle. The red shows oxygenated blood and the blue shows deoxygenated blood.

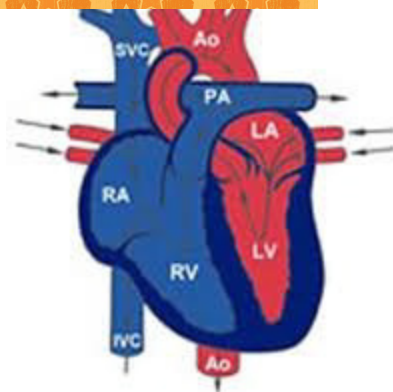

Notice that the walls around the left ventricle are much thicker than the ones in the right ventricle. The reason for this is that because the left ventricle pumps blood to the whole body, so blood will travel a long distance, so it needs lots of muscles to contract and pump the blood more strongly. However, the right ventricle pumps blood the lungs which are very close to heart, the blood does not need to be pumped very strongly.

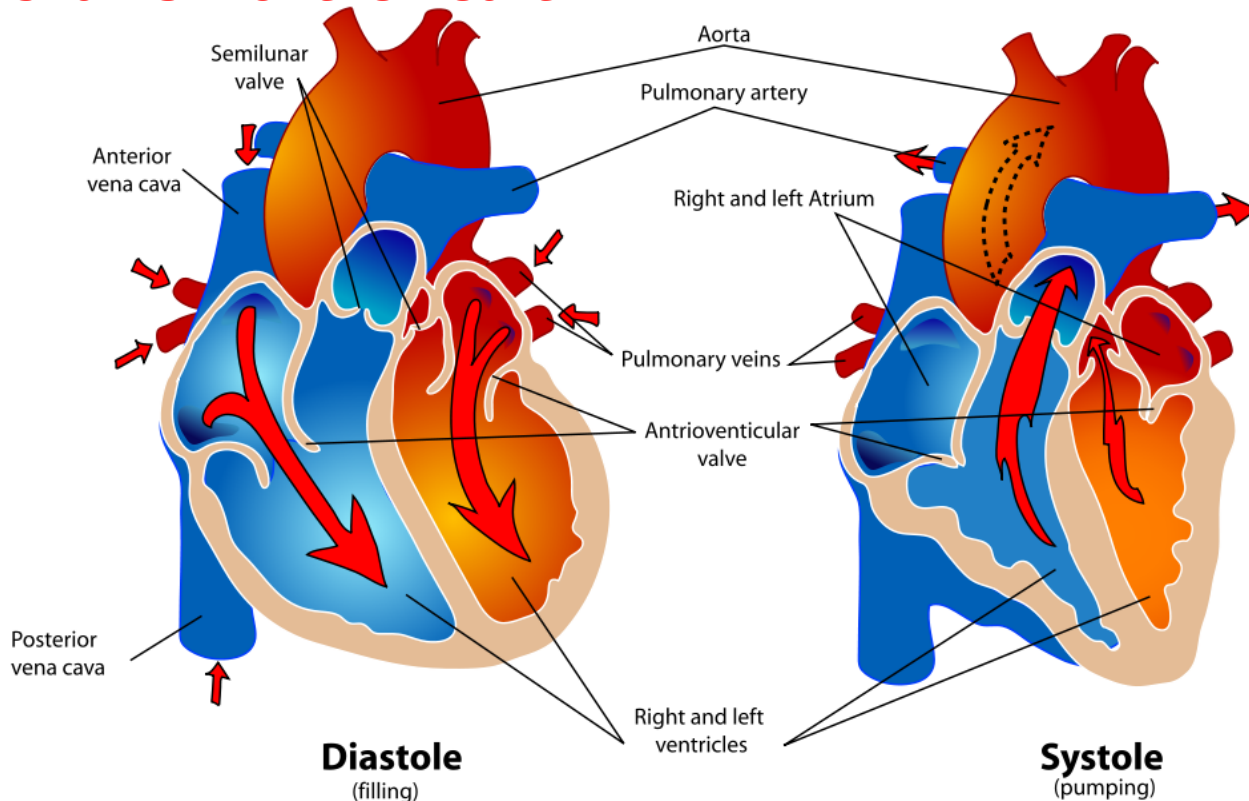

When the heart is being filled with blood (whether from the body or the lungs), this is called the diastole. When the heart is pumping the blood out of it (whether to the body or to the lungs), it is called the systole.

During **diastole, the heart is getting filled with blood, the blood enters the atria first, the atria contract to force blood into the ventricles, both tricuspid and bicuspid valves are open to allow blood into the ventricles and the semilunar valves are shut. Once the ventricles get filled with blood, it is **systole**, the bicuspid and tricuspid valves get shut and semilunar valves are open, the ventricles contract strongly forcing the blood into the Aorta or pulmonary artery.**

During diastole the semilunar valves are snut to keep the blood out of the arteries. During systole the tricuspid and bicuspid valves are closed, to prevent blood from flowing back into the atria when it is pumped. The tricuspid and bicuspid valves are kept fixed by fibres called tendons, they prevent the valves from opening in the opposite direction, allowing backflow.

The tendons also control the opening and closing of the cuspid valves, when the tendons are

loose, the valves are open. When the tendons are tightened the valves close.

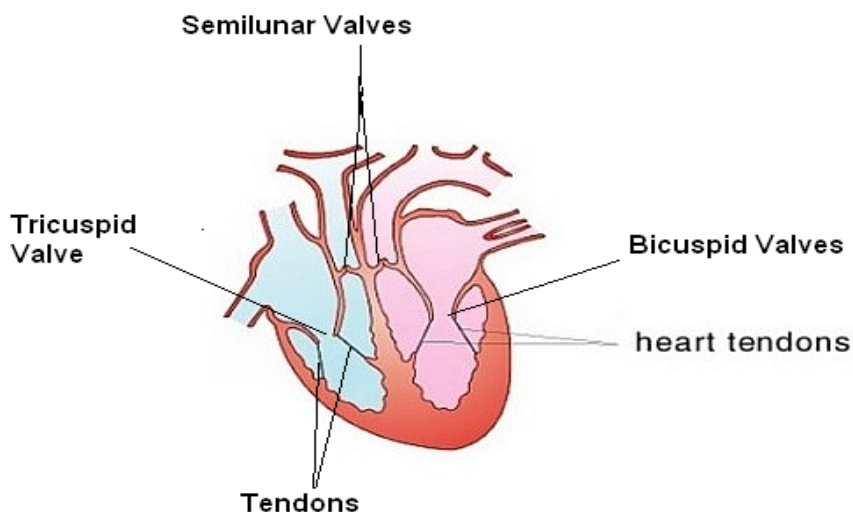

| | Diastole | Systole |
|-------------------|----------|-----------|
| Ventricles: | Relax | Contract |
| Atria: | Contract | Relax |
| Cuspid Valves: | Open | Close |
| Tendons: | Loose | Tightened |
| Semilunar Valves: | Close | Open |

If you listen to your heartbeat, you will hear two sounds, one low and one high. These are results of the systole and diastole. They are the sounds of the cardiac valves opening and shutting.

Coronary Heart Disease (CHD):

The heart, like any other organ, needs a supply of blood containing oxygen and nutrients. In fact, the heart needs a higher amount of blood supply than any other organ

because it is working all the time, and contains a lot of muscles. The coronary arteries are those which supply the heart tissues with blood, they branch from the aorta. CHD develops when cholesterol layers build on the walls of the coronary arteries, partially blocking the path of blood, thus this tissue of the heart is not supplied with oxygen nor nutrients, so it stops working properly. If it is not treated at this age, a blood clot may form near the partially blocked area, completely blocking the artery, when this happens, the blood cannot function anymore, a heart attack occurs, which is extremely fatal

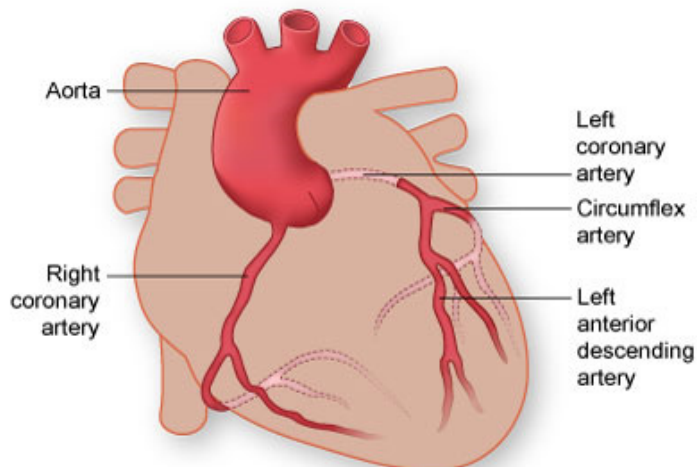

The causes of CHD are mostly in the diet. A diet with lots of fats, increases the chance of cholesterol building up on the walls of the artery, causing CHD, Same thing with salts. Smoking also increases the rate of fat deposition. It was also said that Causes Of CHD are:

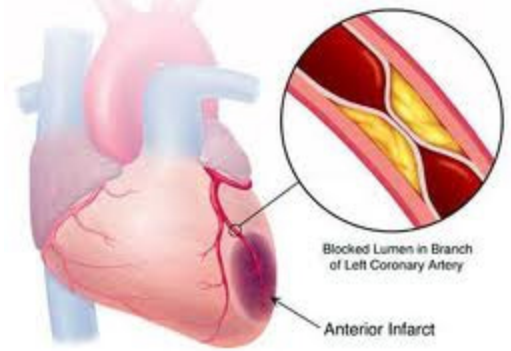

- **Diet full of fats** increases the fats level in blood
- **Diet full of salts**, salts can be deposited in the artery leading to CHD, same as fats or cholesterol
- **Smoking**, carbon monoxides increases fat deposition
- **Stress** was also said to contribute to CHD by raising blood pressure
- **Lack of exercise**, regular workouts improve the blood flow wearing layers of fats or salts deposited on the walls of arteries away.

So to protect you self from CHD you need to avoid diets full of fats and salts, avoid smoking, try to be less stressed out, and exercise regularly.

Tissue Fluid And Lymph:

Tissue fluid is a fluid surrounding the cells of a tissue. It supplies them with all their needs of oxygen and nutrients, and takes away all their waste products including carbon dioxide. Tissue fluid plays a very big role in substance exchange between blood and cells.

How Substance exchange works:

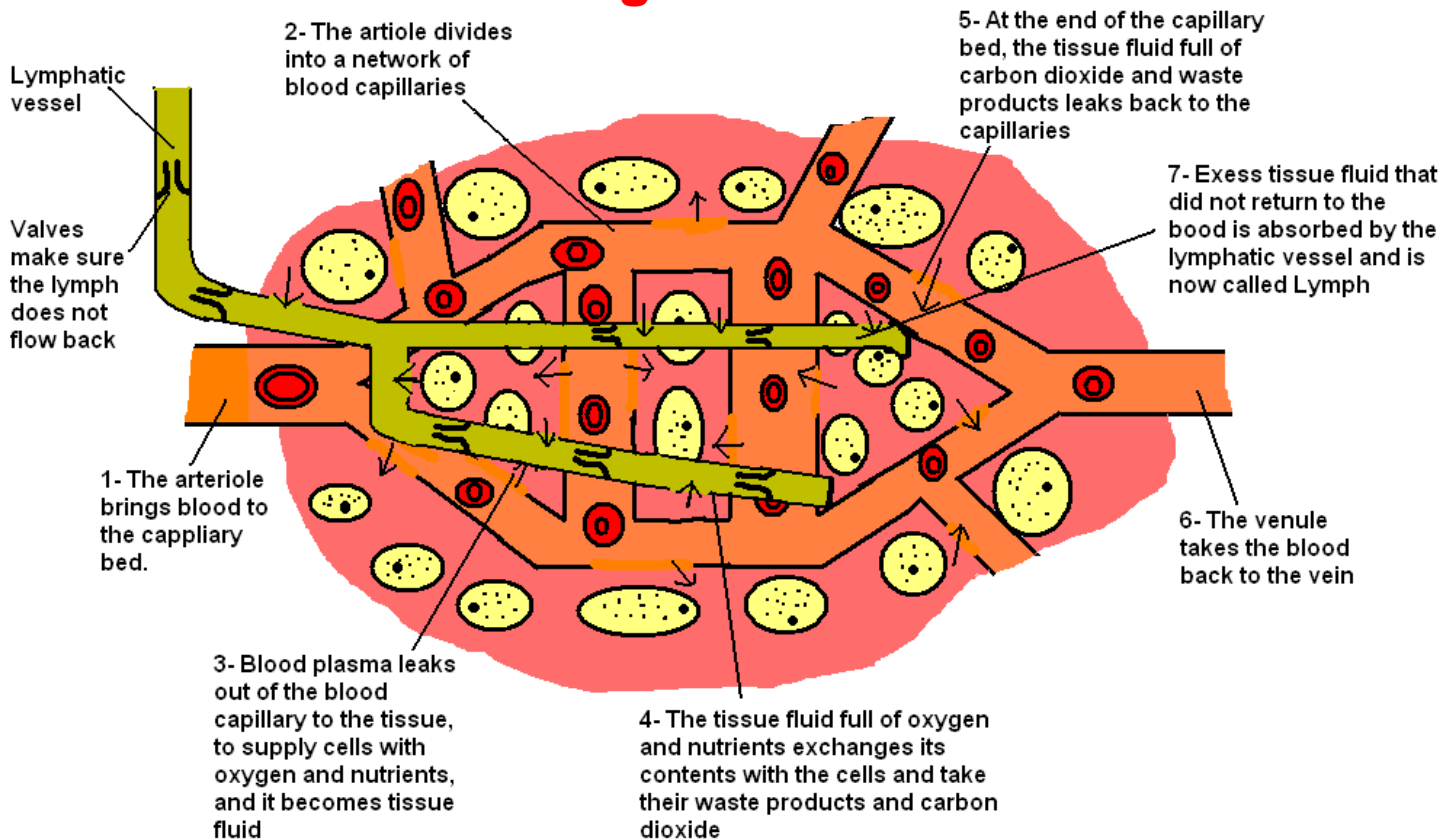

Plasma from the blood capillaries move to the tissue through gaps in the walls. They become tissue fluid. They exchange their content of oxygen and nutrients with the cells and take carbon dioxide and waste products. At the end of the capillary bed, the tissue fluid leaks back into the blood, and becomes plasma

again, but not all of it. A little of it is absorbed by the lymphatic vessel and becomes lymph. The lymphatic vessel takes the lymph to the blood stream by secreting them in a vein near the heart, called subclavian vein. The lymph in the lymphatic vessels are moved along by the squeeze of muscles against the vessel, just like some veins.

The lymphatic system plays a big role in the protection against disease. It produces the white blood cells lymphocytes. Which kill any cell with a different antigens than the ones in your body cells. So if bacteria get into your body, your lymphocytes quickly recognise them as foreigners and will divide and kill them.

Lymphocytes are considered a problem when it comes to organs transplant. For example if someone (recipient) with renal failure receives a kidney from another person (the donor), the cells of the kidney will have different antigens than the other cells in the patient's body. The lymphocytes will consider the cells of the kidney an enemy and start attacking it, this is called tissue rejection. Organ transplant is perfect in one case, this is when the donor and the recipient are

identical twins, because the antigens of their cells perfectly match. In other cases the recipient is given immunosuppressant drugs to actually weaken their immune system to prevent tissue rejection.

Brief Summary Of Functions Of The Lymphatic System:

- **Production of white blood cells lymphocytes**
- **Transport of digested fats from villi to blood stream**
- **Transport of lymph from the tissue fluids to the blood stream at the subclavian vein.**

Chapter 9: Plant Nutrition

Plants are living organisms, they need food in order to keep living. The way they obtain their nutrients however, is completely different than that of ours. Plant make most of their nutrients by them selves, they just need 2 raw materials, these water and carbon dioxide.

The leaf of a plant is considered the kitchen of it. It is where food is made, later on you will see how the leaf is adapted to making food.

Structure Of The Leaf:

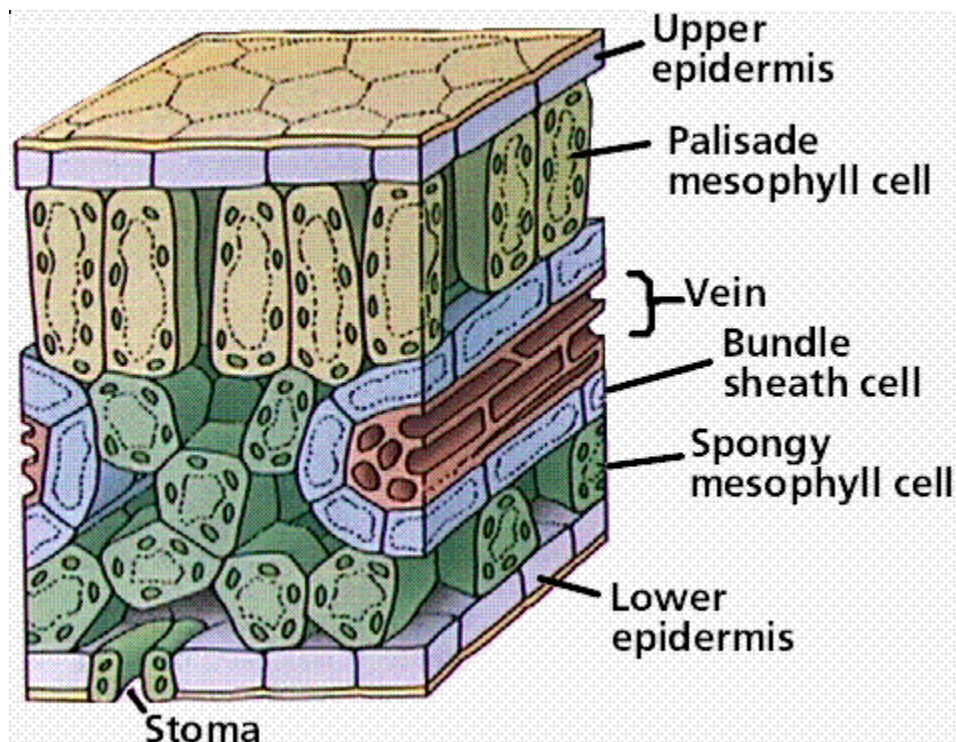

Upper Epidermis: It is a layer of cells

leaf and protect it, it is covered by a layer of wax called **cuticle**.

Mesophyll Layer:

- **Palisade Mesophyll:** a layer of palisade cells which carry out most of photosynthesis
- **Spongy Mesophyll:** a layer of spongy cells beneath the palisade layer, they carry out photosynthesis and store nutrients.

Vascular Bundle: it is a group of phloem and xylem vessels that transport water and minerals to and from the leaves.

Lower Epidermis: similar to the upper epidermis, only that it contains a special type of cells called **guard cells**. Guard cells are a specialised type of cells that control the passage of Carbon dioxide into the Cell and the passage of Oxygen out of the cell by Opening and closing the Stomata (a hole in the leaf

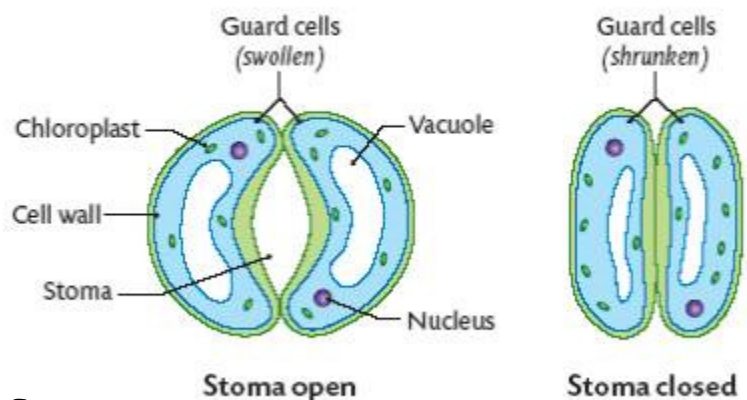

Through which (gases pass) so guard cells are responsible for the gas exchange.

Photosynthesis:

Photosynthesis means “making with light”. It is the process by which plants make useful glucose out of the raw materials water and carbon dioxide, using light energy from the sun.

Water is essential for photosynthesis, it is sucked up from the soil by the roots and transported up the stem to leaves where it is put into use.

Carbon dioxide, just like water is essential for photosynthesis. It moves into the leaf from the air by diffusion, through the stomata (tiny wholes in the leaf).

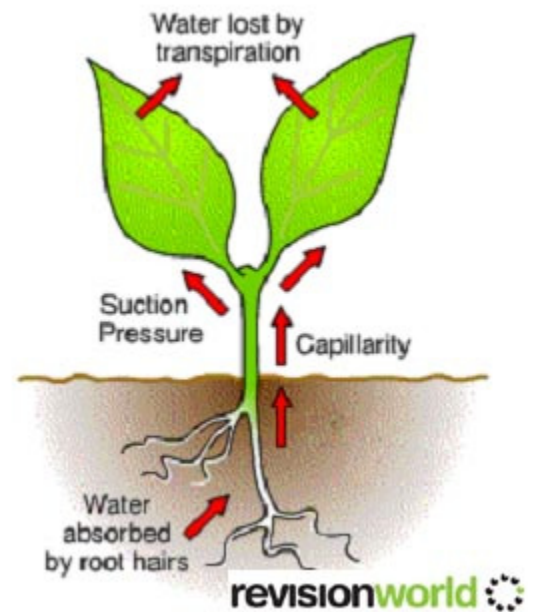

Once carbon dioxide and water are present in a leaf, one condition for photosynthesis is needed, that is light. The two cells in the diagrams are called palisade cells (the rectangular one) and spongy mesophyll cell (the circular one), these are the cells where photosynthesis takes place. They are structures called chloroplasts, these structures contain a green pigment named chlorophyll, this is to trap sunlight to be used in energy, a large number of chloroplasts is required for photosynthesis.

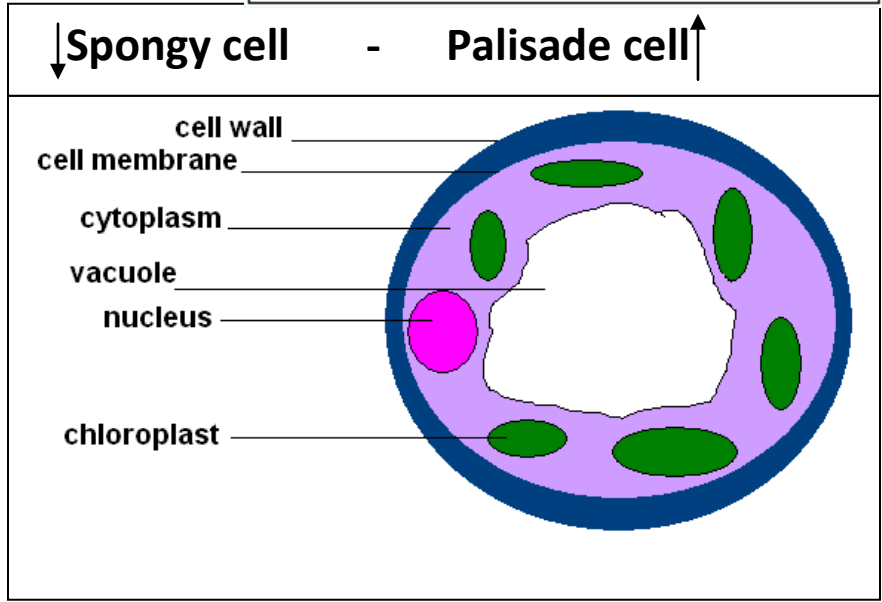
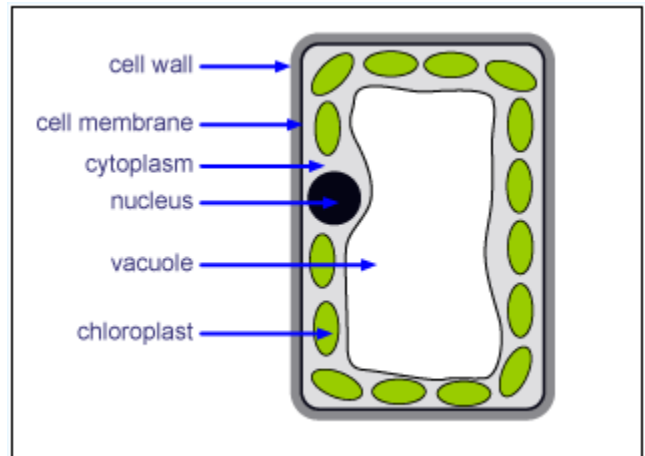

How photosynthesis happens:

- Carbon dioxide and water enter the cell
- The cell traps light energy using chloroplasts
- The energy is used to split water (H₂O) into hydrogen and oxygen

- The oxygen is excreted outside atmosphere as a waste product
- The hydrogen reacts with carbon dioxide forming glucose.

The Balanced And Word Equations Of Photosynthesis

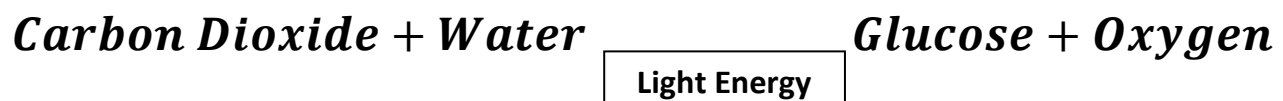

Carbon Dioxide Supply:

The carbon dioxide moves to the leaf from the atmosphere by diffusion through tiny holes in the leaf called stomata. Carbon dioxide is not present in a high concentration in air, but compared to its concentration inside the leaf, it is more in the air. This is because the cells inside the leaf are always doing photosynthesis (at daytime), converting the carbon dioxide into the glucose quickly, thus the concentration of it inside the leaf decreases, making a concentration gradient for diffusion from the atmosphere to the leaf.

Water Supply:
The water is absorbed by the roots of the plants, then they are transported upwards through a hollow tube called the xylem vessel, till it reaches the leaf where photosynthesis takes place, it enters the leaf through holes in the xylem. Excess water leaves the cell through the stomata, this is called “transpiration”

Sunlight Supply:

The leaves are always exposed to sunlight at daytime. The sun penetrates the transparent layers on the leaf till it reaches the mesophyll layer, where photosynthesis take place. Palisade cells are nearer to the surface of the leaf than the spongy cells, so they receive more of the light and make more photosynthesis.

Factors Needed For Photosynthesis:

- **Water**
- **Carbon Dioxide**
- **Light**

- **Amount of water:** the rate increases as it increases
- **Concentration of carbon dioxide:** the rate increases as it increases
- **Light intensity:** the rate increases as it increases

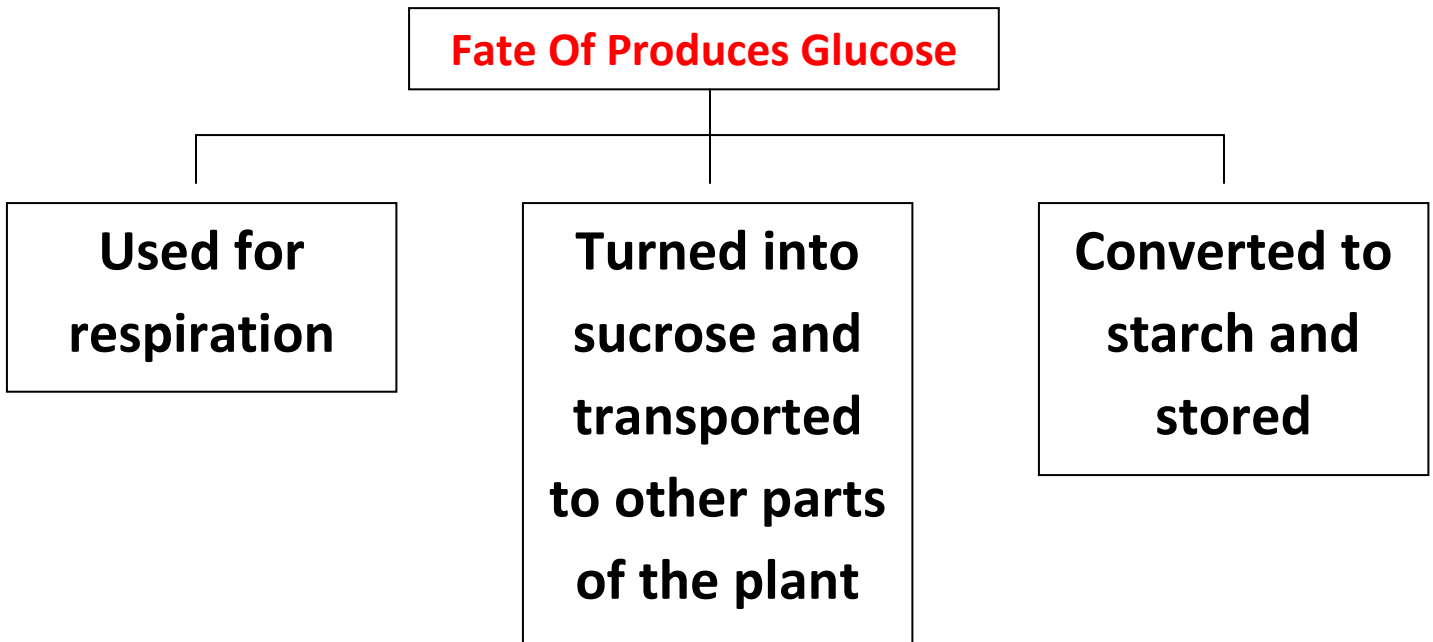

Plants at night:

At night, the plant performs several process to convert the stored starch into many useful nutrients like:

- **Sugars for respiration**
- **Cellulose and proteins for making cells**
- **Vitamins to help in energy action**
- **Fats as a long term storage material**
- **Remaining starch is temporarily stored.**

At daytime, the guard cells open the stomata to allow gaseous exchange, this occurs according to the following steps:

- **Sunlight increases the potassium concentration in the vacuoles of the guard cells, the water potential decreases making a gradient between the guard cells and the surround epidermal cells.**
- **Water moves by osmosis into the guard cells from the epidermal cells**
- **The water raises the pressure inside the guard cells.**
- **The cell wall adjacent to the stomata is thicker and less stretchable then the cell wall on the other side.**
- **The pressure expand the whole cell except for the inner cell wall (adjacent to the stomata) creating a curve and a pore between the two guard cells.**
- **The stoma opens.**

At night however, the mechanism

- **Potassium level decreases in the vacuole of the guard cells.**
- **Water potential increases in the cell and water diffuses out of it**
- **The guard cells straighten up because of low pressure closing the stoma.**

Mineral Requirements:

The plant is also in need for mineral ions to control chemical activities, grow, and produce materials. The most important minerals are:

- **Mg⁺² (Magnesium ions):** they are important for the production of the green pigment chlorophyll. Lack of it results in lack of photosynthesis and wilting of the leaves
- **Nitrates:** these are the sources of nitrogen, they are required to make amino acids and proteins by combining with glucose. Lack of it results in deformation of the plant structure making it small and weak.

Both mineral ions are absorbed from the soil.

Fertilisers:
Sometimes the soil is lacking of the mineral ions needed, this problem can be solved by adding fertilisers to the soil. Fertilisers are chemical compounds rich in the mineral ions needed by the plants. They help the plants grow faster, increase in size and become greener, they simply make them healthier and increase the crop yield. But there are disadvantages of fertilisers, such as:

- **Excess minerals and chemical can enter a nearby river polluting it and creating a layer of green algae on the surface of it, causing lack of light in the river, thus preventing the aqua plants photosynthesizing.**
- **When living organisms in the river or lake die, decomposers such as bacteria multiply and decay, respire using oxygen. Eutrophication takes place eventually.**



A green house is a place covered by transparent polythene. In green houses, the limiting factors of photosynthesis are eliminated, and the plants are provided the most suitable conditions for a healthy, rapid growth.



The soil in green houses is fertilised and very rich in mineral ions, assuring healthy, large yields. More carbon dioxide is supplied to the crops for faster photosynthesis. The polythene walls and ceiling allow heat waves and light rays only to enter and prevent harmful waves, thus providing a high light intensity and optimum temperature, sometimes a heating system is used too. A watering system is also present.

The disadvantages of green houses are that it is too small to give a large yield and that it is expensive.



Chapter 10: Transport in Plants

Just like humans, plants have a transport system of vessels and cells that transports water, minerals and other nutrients around the plant.

Structure Of Plants:

A plant is divided into two section, whatever is above the soil, is called the shoot, and whatever is below the soil is called the root. The root is simple, it is usually a main root with extensions of thinner ones. The shoot however, is made of several parts. The roots have the specialised cell, root hair cell, which we looked closely before, the root hair cells absorbs water from the soil and fixes the plant into the ground. In the root also, starts the transports system of the plant which extends all the way from the root up to the tip of the stem.

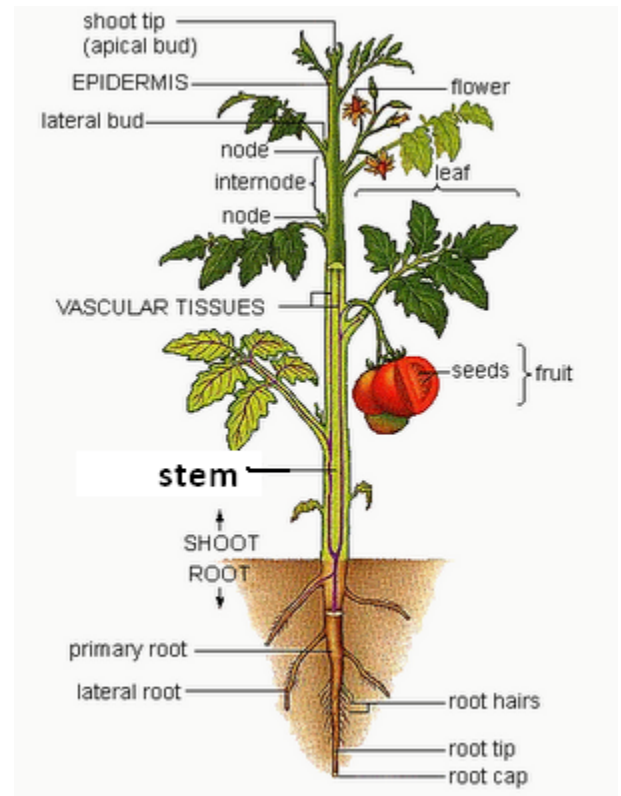

the diagram shows a section through the root. The root hairs of the root hair cells are visible. In the centre of the root, is the beginning of the transport system of the plant, which is made of two main transport tissues, the **xylem tissue** and the **phloem tissue**.

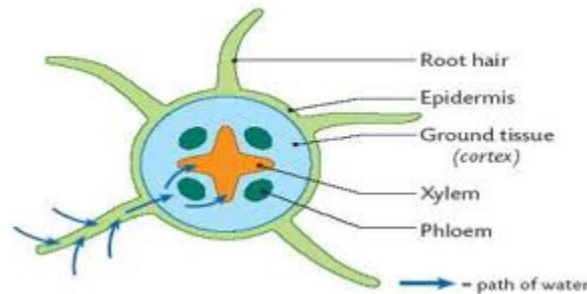
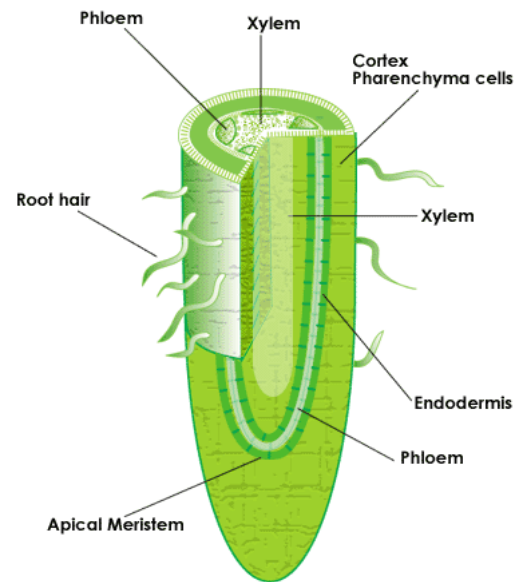

The diagram above shows a transverse section through a root. We can see than there are two types of hollow tubes, the xylem is the one in yellow and the phloem is the one in blue. Each type of these tissues functions adapts differently to the other.

The diagram on the right shows a transverse section of the stem. We can see that the xylem and phloem are still there, but they are arranged differently, they are both put together in an egg shaped structure separated by a cambium.

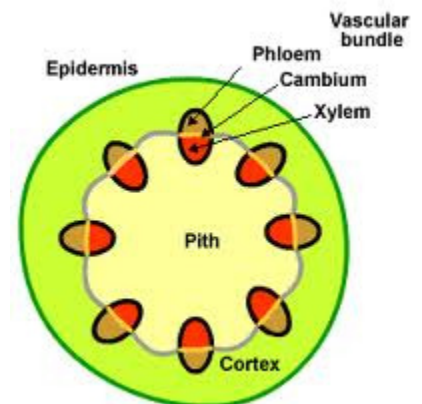

Together they are called the vascular tissue, is surrounded by what is called the cortex.

Structure Of The Xylem Tissue:

The xylem vessels are long hollow tubes made of dead lignified cells arranged end to end forming a continuous. The xylem vessel is specialised to transport water and dissolved minerals from the root up to all the other parts of the plant, and also to help supporting the stem and strengthening it. The walls of the xylem vessel contains holes called pits which water enters through. The xylem tissue is adapted to its functions in different ways. For instance, the cell wall of the dead cells of the walls of it is made of lignin, which makes it stronger to support the stem, the fact that they are dead makes all the water absorbed by the root hair cells get transported to the leaves without being used by the cells of the vessel. The tube is also very narrow, to make it easier for the water to be transported upwards.

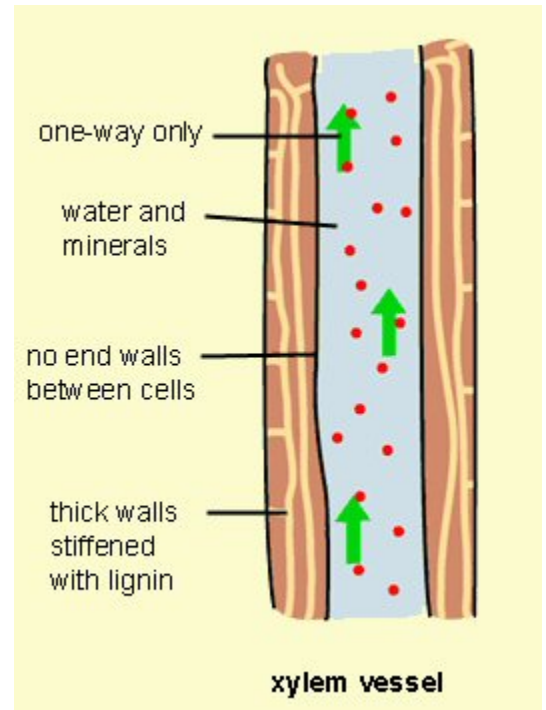

Structure Of The Phloem Tissue:

This is a long tube that runs alongside the xylem tissue. They are made of long narrow tubes with perforated sieve plates along the thin length. The function of the phloem tissue is to transport food nutrients such as glucose and amino acids from the leaves and to all other cells of the plant, this is called translocation. Unlike the xylem, the phloem tissue is made of living cells, because as we will see later, there are several forces causing the transport of water in the xylem, but there are no forces causing the translocation, so substances need to be moved along using active uptake, which needs energy. The cells of the phloem vessels contains a cytoplasm but no nucleus, and its activities are controlled by a companion cell next to it which has a nucleus, but companion cells have no function in translocation.

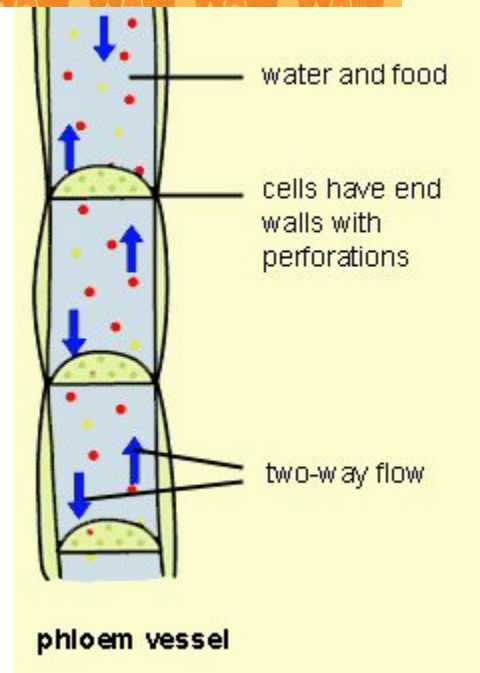

The water reaches the leaves from the soil by several steps, starting at the root:

- **The root hair cells have a concentrated cell sap vacuole which means that the water potential is low in it and high in the soil, osmosis takes place and water enters the cell.**
- **Minerals are also present in the soil but in low concentration, using active up take, the root hair cells takes the mineral ions in.**
- **The mixture of mineral and water moves from the root hair cells through the other cells by osmosis active uptake till it reaches the xylem vessel in the root, it enters the xylem through pits.**
- **The xylem vessel transports the water from the root to the stem (forming the vascular bundle with the phloem) and upwards to the leaves.**
- **The water and dissolved minerals leave the xylem and get absorbed by the cells in the leaves.**

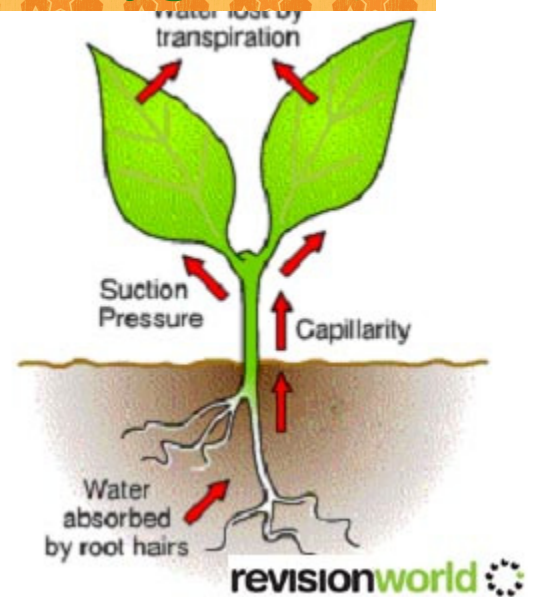

There are three factors affecting the movement of water:

- **In root hair cells, the mineral concentration is high, it helps pushing the water towards the xylem and the stem.**
- **Capillarity is a factor that helps in the movement of water in the xylem vessels. The water molecules are attracted to each other, as one moves upwards it pulls its neighbouring molecule with it. The molecules are also attracted to the walls of the xylem, the narrower the xylem the easier it is for water to move.**
- **Transpiration force is the most effective force that causes water movement. In the leaf, the water evaporates and leaves the plant through the stomata, one molecule escapes pulling the other with it, and so on, creating a suction force. You can think of it as using a straw to drink.**

Factors Affecting The Transpiration

- **Humidity:** humidity means more water vapour in the air, which means water vapour has a higher concentration in the atmosphere than inside the leaf, so transpiration will be much slower because the diffusion of water vapour outside the leaf will be slow. The higher the humidity the slower the transpiration.
- **Temperature:** when the temperature is high, molecules move faster and evaporate faster, so transpiration rate increases. The higher the temperature the faster the transpiration.
- **Wind speed:** when the wind is fast, it takes humid air away from around the leaf, making the diffusion rate faster, so the faster the wind the faster the transpiration.
- **Light:** when light intensity is high, the stomata will open to let Carbon dioxide in for photosynthesis, the water vapour has an easier chance to escape. In the dark the stomata are closed, the transpiration rate is very slow.

than the rate of water absorption. The amount of water in the plant keeps on decreasing. The water content of cells decreases and cells turn from turgid to flaccid. The leaves shrink and the plant will eventually die.

Translocation:

This is the transport of organic food such as sucrose and amino acids in the plant through the phloem vessels.

Glucose, the product of photosynthesis is the most important food of the plant. Because from it, it makes most of its other nutrients. Glucose is converted into an other more complex sugar called sucrose. Sucrose in the leaves enter the phloem vessels. The phloem transports it to every other part of the plant where it is made use of. Amino acids are also transported in the phloem.

Sucrose and amino acids are transported to every tissue of the plant, each cell use it in a different way. Root cells convert sucrose into glucose for respiration and store it. Growing cells make cellulose for cell

www.studyguide.pk studyguide.pk
walls from sucrose and use the amino acids and proteins for growth. And fruits use the sucrose to make the attractive scent and tasty nectar to attract insects.

The areas of the plant where sucrose is made, are called sources, and where they are delivered to and made use of are called sinks.

Pesticides And Insecticides:

Some insects and pests feed on plants and harm them. A way to prevent this problem is to spray the plant with insecticides and pesticides. But the problem here is that these chemicals also kill insects and pests that are useful to the plant. This is why systemic pesticides are used. When sprayed, they are absorbed inside the plant and distributed all over the plant. When the harmful insects and pests eat a part of the plant, they eat the poison with it, thus they die and harmless ones are safe.

Adaptation Of Special Plants:

Desert Cactus:

- **Leaves are needle like spines to reduce water loss by transpiration. They are covered with a thick cuticle to insulate heat and prevent water escaping. The stomata of the leaves are sunken into the epidermis to be away from external features that increase transpiration.**
- **The stem is short to prevent wind from blowing it away. It is round to decrease surface area and transpiration rate. Photosynthesis takes place in the stem.**
- **Roots are very long and deep into the soil to have access to underground water and rain water. Root hair cells have a very concentrated cell vacuole to increase osmosis rate.**



Pond Plants:

- **Wide, broad leaves on surface of water to exchange gases. Stomata on upper side of the leaf to be in contact with air**

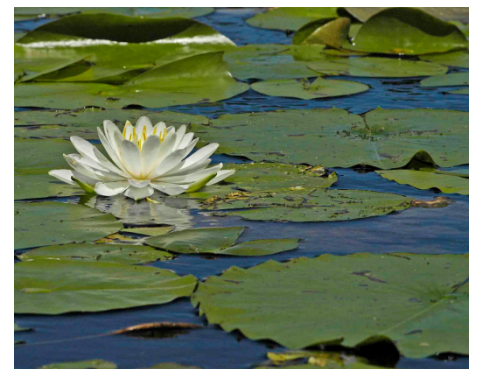

Chapter 11: Air & Water:

Water:

Water is perhaps the most known substance. This is perhaps because of its abundance and numerous uses. Water is, H_2O , is the most popular solvent for chemical reaction.

Tests for Water:

There are several tests for water, the easiest one which you can perform at home is physical and doesn't involve any reaction. It is testing its boiling point. Pure water boils at $100^{\circ}C$ sharply, and freezes at $0^{\circ}C$ sharply.

There are chemical reactions which could be applied to test for water. For example if you add water to anhydrous copper sulphate powder which is white in colour, it forms a blue solution and may give heat out. If you crystallise the solution you will obtain blue crystals of hydrated copper sulphate.

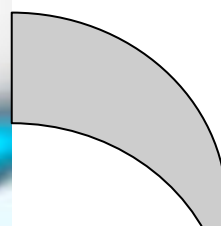
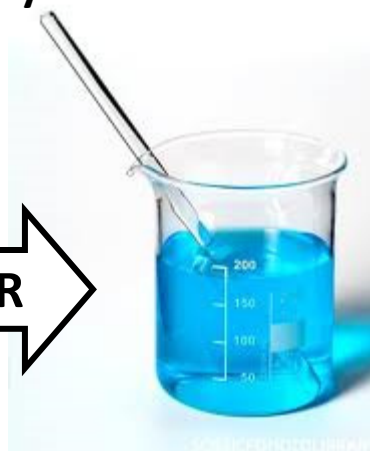
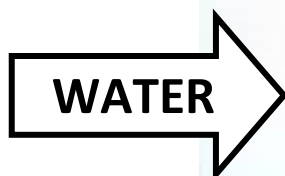

CRYSTALLISATION

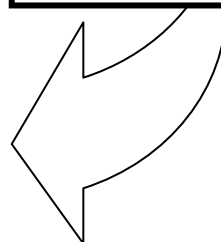

Another test for water is adding it to anhydrous cobalt chloride which is blue in colour, if water is added to it the anhydrous salt forms a pink solution. If you crystallise the solution of cobalt chloride you will obtain pink hydrated cobalt chloride crystals.

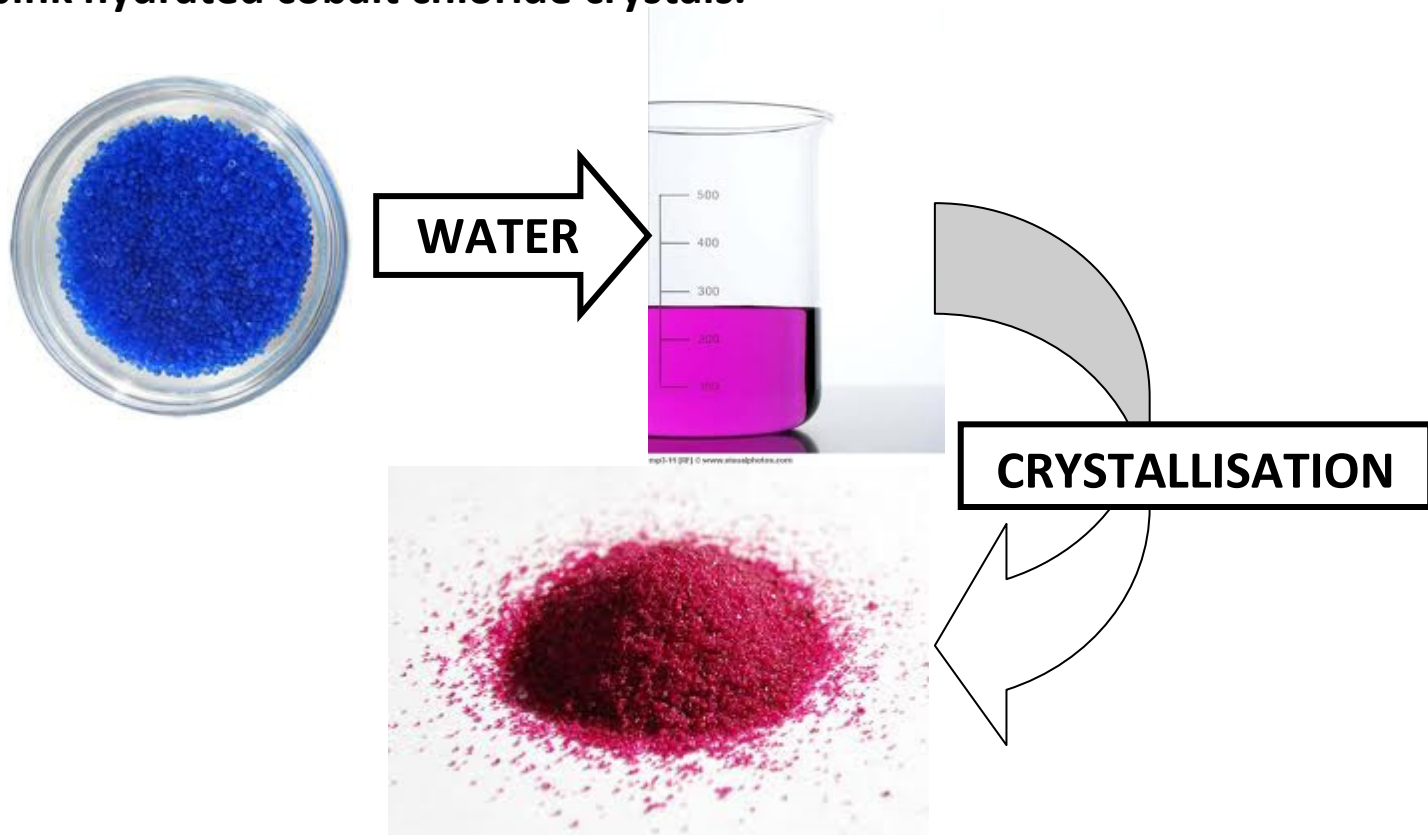

Uses of Water:

Water has many uses in both the industry and in homes.

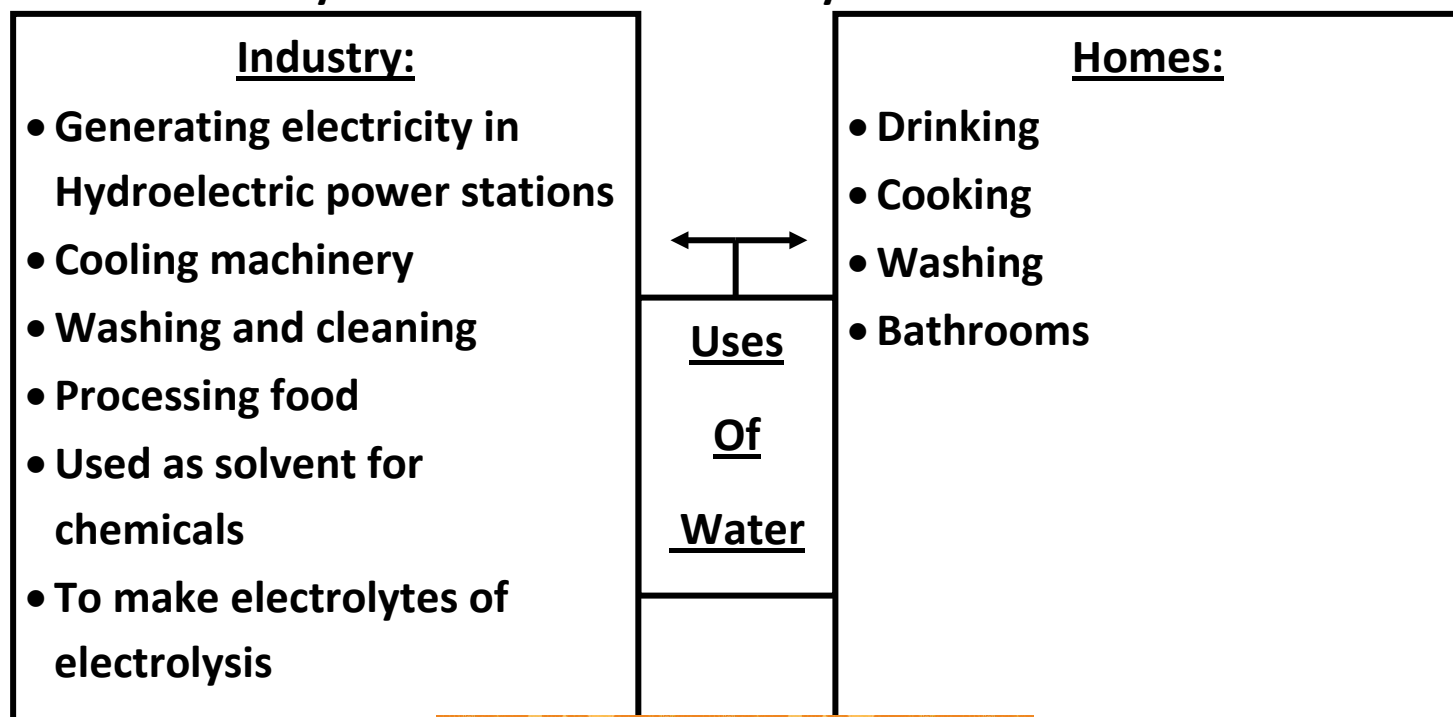

Water Purification

Water that exists naturally in earth is never pure. There are always impurities in it ,sometimes in large amounts. In fact water could very well be contaminated with diseases and bacteria. This is why water has to be purified before it is put to use. Water purification involves two processes (**Filtration & Chlorination**) done in several steps:

1. Water is taken from reservoirs or any other source to the water treatment plant
2. Water is passed through filters to remove large, floating objects such as pieces of rocks or mud
3. Smaller particles are removed by adding aluminum sulfate which makes them stick together in large pieces and settle down
4. Water is passed through sand and gravel filters which filter off small particles and may kill some bacteria (filtration is done)
5. Chlorine gas is bubbled through the water to kill all bacteria living in the water making the water sterile
6. The water may end to be slightly acidic, small amounts of sodium hydroxide are added to treat this. Fluoride might be added to because it helps in preventing tooth decay.
7. Water is then delivered to homes.

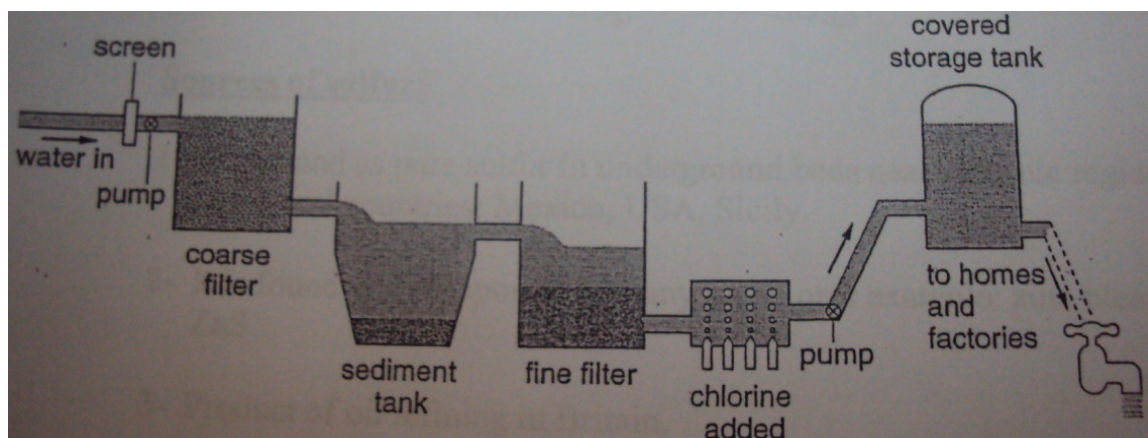

Air: www.studyguide.pk

Air is a mixture of gases that makes up the atmosphere of earth.

Composition of Clean Air:

Clean air is made up of nitrogen, oxygen and traces of other gases including carbon dioxide and noble gases. There are also traces of water vapour in air. Noble gases present in air are mostly argon and some helium, neon, krypton and xenon.

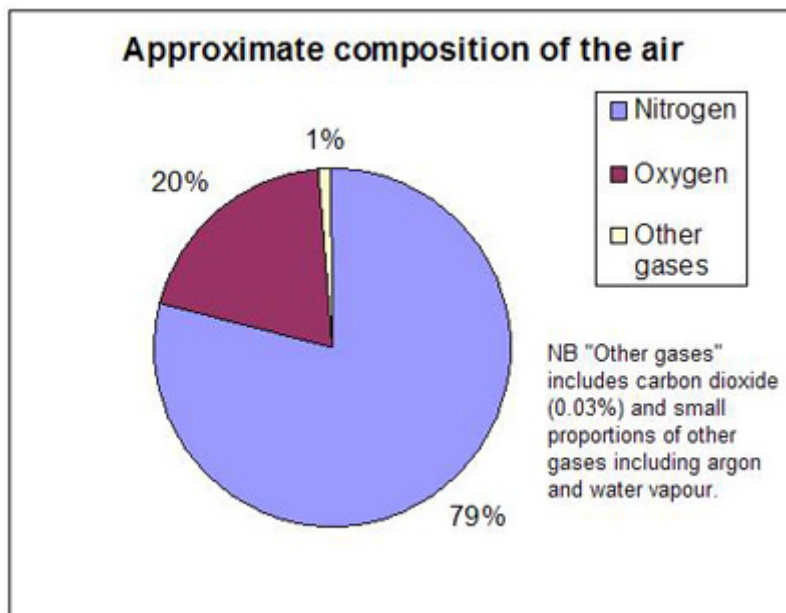

Fractional Distillation of Liquid Air:

Fractional distillation of liquid air is used to separate gases of air, specially nitrogen and oxygen. Like fractional distillation of petroleum, it is based on the boiling points of the components of air.

| <u>GAS</u> | <u>Boiling Point:</u> | <u>Makes Up __% Of Air</u> |
|----------------|-----------------------|----------------------------|
| Carbon Dioxide | -32 °C | <1% |
| Xenon | -108 °C | <1% |
| Krypton | -153 °C | <1% |
| Oxygen | -183 °C | 20% |
| Argon | -186 °C | <1% |
| Nirtogen | -196 °C | 79% |
| Neon | -246 °C | <1% |
| Helium | -249 °C | <1% |

Steps of Fraction Distillation of Liquid Air:

- Clean air is cooled till -80°C , Carbon dioxide sublimates into solid and is collected, water vapour condenses then freezes into ice and is collected too.
- The cold air is now put into a compressor which increases its pressure to 100 atm. This causes the air to warm up so it has to be cooled down again.
- The re-cooled, compressed air is then allowed to expand and lose its pressure, this causes it to cool further.
- The air is now recompressed then expanded again to keep cooling it. This stage is repeated until all gases liquefy, this is at a temperature below -200°C .
- Then the cold liquid air is brought in a fractionating column and left to warm slowly.
- Gases separate one after another according to their boiling points. The gas with the lowest boiling point evaporates first, followed by the gas of the second lowest boiling point and so on.
- The three main gases of air (nitrogen, oxygen and argon) evaporate in the following order:
 - 1- Nitrogen (-196°C)
 - 2- Argon (-186°C)
 - 3- Oxygen (-183°C)
- Gases are collected and stored separately.

Air Pollution.

Pollution is the presence of harmful substances. Air pollution is the presence of pollutant gases in the air. A pollutant is a substance that causes pollution. Pollutants are:

Carbon Monoxide

Oxides of Nitrogen

Sulphur Dioxide

Lead Compounds

Carbon Monoxide: Carbon monoxide (CO) is one of the poisonous pollutants of air. It is considered a pollutant because it can kill living organisms. The main source of carbon monoxide is factories which burn carbon-containing fossil fuels since CO is one of the products of the incomplete combustion of fossil fuels. Carbon monoxide could be treated by installing catalytic converters in chimneys of the factories.

Sulphur Dioxide: Sulphur dioxide (SO₂) is considered a pollutant since it contributes to acidic rain. Sulphur dioxide is a product of two process, these are combustion of sulphur –containing fossil fuels and extraction of metals from their sulphide ores (such as zinc sulphide). The problem associated with sulphur dioxide is that when it rises in the air from chimneys of factories, it mixes with water vapour of clouds and air. This results in the formation of sulphuric acid (H₂SO₄). When it rains, rain water which falls becomes acidic. Acid rain causes death to water creatures since it makes water acidic, acidifies soil causing death to plants and deforestation, reacting with limestone from buildings and sculptures corroding it, and may also cause lung cancer. Sulphur dioxide could be treated before it leaves chimneys of factories by reacting it

with limestone which is a neutralisation reaction. This process is called desulphurisation.

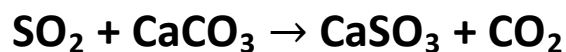

Acid Rain Effects:



Oxides of Nitrogen (NO & NO₂): Nitrogen oxides are formed at high temperatures as a result of nitrogen and oxygen reacting. In cars, engines have a very high temperature, this creates a chance for nitrogen and oxygen present in air in the engine to react forming nitrogen monoxide.

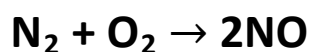

The produced carbon monoxide is released through the exhaust with other waste fumes. Nitrogen monoxide reacts with more oxygen from air producing nitrogen dioxide.



The problem associated with nitrogen dioxide is similar to that of sulphur dioxide. It rises up in the air and mixes with rain water forming nitric acid. This causes acid rain. Nitrogen oxides can also cause health respiratory problems to humans and animals. To treat this issue, cars are

now fitted with devices called catalytic converters which eliminate nitrogen oxides.

Lead Compounds: Compounds of lead are waste products of fuel burning in cars. They are considered pollutants because they are poisonous and they are said to cause mental disabilities to young children. To treat this problem, gas stations now provide unleaded fuel.

Catalytic Converters:

Car fuels contain carbon. So carbon monoxide gas is released by cars as waste fumes, as well as nitrogen oxides. These are pollutant gases. To prevent these gases from polluting air, a device called catalytic converter is fitted at the end of the exhaust. This device contains a catalyst which catalyses the reaction between these two gases producing two harmless gases, nitrogen and carbon dioxide:

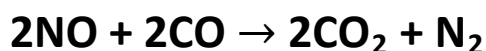

The catalyst of the device works best at temperature around 200°C .

The Carbon Cycle:

The carbon cycle is a natural global cycle of the element carbon. It is what maintains a constant level of carbon dioxide in air (0.03%). The cycle goes as follows:

- Plants absorb carbon dioxide from air and undergo photosynthesis reaction which turns it into glucose and produces oxygen

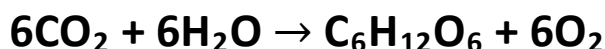

- www.studyguide.pk
- The carbon is now stored in plants as glucose. One of two things happen, either the plants get eaten by animals or humans, or the plant dies and decays.
 - If the plant is eaten by animals or humans, glucose in the plant is used by them in a process called respiration to release energy for their body. This is also a combustion reaction.

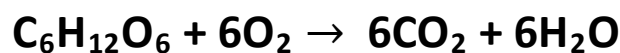

Respiration is the opposite of photosynthesis. Carbon dioxide is one of the products of it, which is released by the humans through breathing into the air. Thus carbon dioxide returns to the atmosphere.

- If the plant dies. It is buried underground and by time it decays forming coal and other fossil fuels. These substances contain the carbon which was made and stored by the plants and they are then taken by power stations which put them to use.
- Power stations burn carbon-containing fuels that were obtained as coal or fossil fuels formed by dead plants. This is a combustion reaction.



Carbon dioxide is result of these reactions. Carbon dioxide produced is released to the air through chimneys of power stations. Thus the cycle is completed and all carbon dioxide returns to the atmosphere.

Green House Gases:

The sun sends energy to the earth in two forms, light and heat. Some of the heat energy reflects back to the space, some however are trapped inside the Earth. This is caused by some gases and it is called **the green house effect**. The main green house gases are carbon dioxide and methane.

Carbon dioxide is formed in many ways. It is formed on a large scale in power stations by the combustion of carbon containing fuels. Carbon dioxide is also caused by respiration of living organisms. The gas can also be produced by a reaction between an acid and a carbonate, like that of the corrosion limestone.

Methane, the other green house gas is formed by animals. When animals eat and digest their food, methane gas is one of the waste products of this process. It is released to the atmosphere by animals. When plants die and decompose over many years, methane gas is also produced.

The green house effect poses a threat to the world now a days. This is because green house gases, specially carbon dioxide, have increased in amounts in the atmosphere due to activity of humans. Lots of fuel combustion is taking place around the world, increasing the levels of CO_2 , while trees are being chopped of to made use of instead of leaving to replace CO_2 with oxygen. These activities cause an increase of the levels of CO_2 in the atmosphere, which leads to more heat trapping in earth. This rises the global temperature of the earth causing what's called **global warming**.

Global warming is the increase of the temperature of the earth due to the increase of levels of green house gases. Global warming has effects on the earth. To start with, the north and south poles, which are made of ice, will start to melt raising sea levels. The sea temperature will also rise causing death to marine lives. This is also accompanied by other natural disasters such as hurricanes and heavy rains.

Humans could prevent this by reducing combustion of fossil fuels and leaving forests to live.

Rusting:

Rusting is the corrosion of iron as a result of reaction with oxygen from air and water. If iron objects are left uncovered and exposed to air & water, iron will react with oxygen forming hydrated iron oxide (also known as rust). Rust is a reddish brown flaky solid which will fall off the object making it thinner and loses its shape. Iron must come in contact with air and water in order for rusting to happen. The formula of rust is $\text{Fe}_2\text{O}_3 \cdot x\text{H}_2\text{O}$. Steel can also rust since it is made up of mostly iron.

Rusting can become very dangerous in some cases. For example, bridges that cross rivers stand on columns that are made of iron. The conditions of rusting are present in this case (Water from the river and oxygen from the air). There is a risk that the columns will rust and collapse with the whole bridge. In another case, ships are made of iron. Again, the conditions of rusting are present (water from the sea and oxygen from the air). In fact, this situation is more critical because sea water contains minerals that act as a catalyst to speed up the reaction of rusting.

There are some available methods to prevent rusting. These methods are based on covering the iron object with another substance to create a barrier between iron and oxygen and water so that rusting does not take place.

Painting: The iron or steel object is painted all over. The paint creates the desired barrier to prevent iron or steel coming in contact with air and water. This method is used in car bodies and bridges.

Electroplating: The iron or steel object gets electroplated with another metal that doesn't corrode. The object is usually electroplated with tin or chromium since they are very unreactive. This method is used in food cans and car bumpers.

Sacrificial Protection: This method is based on the idea that metals that are higher than iron in the reactivity series will react in preference to it and thus that metal is corroded and the iron is protected. Metals usually used as protectors in this method are zinc and magnesium since they are higher than iron in the reactivity series. In ships for example, zinc or magnesium bars are attached to the iron base of the ship which is in contact with water and oxygen from air. But rusting doesn't take place since zinc or magnesium is the one that gets corroded. These bars must be replaced from time to time because once they all get corroded, iron becomes unprotected and rusts. This method is usually used in ships or bridge columns. The zinc or magnesium bars do not have to completely cover the iron or steel because as long as they are attached to each other the zinc or magnesium bars get corroded and not the iron.

Galvanisation. Galvanisation is a very reliable method for preventing rusting. It is basically covering the whole object by a protective layer of zinc. This can be done either by electroplating the object with zinc or dipping it into molten zinc. The zinc layer provides a barrier that prevents iron or steel from coming in contact with air and water. The zinc gets corroded instead iron thus protecting it. If the a part of the zinc coat falls off and the iron or steel gets exposed to air and water, the bare part still doesn't get corroded since it is protected by sacrificial protection now.

Chapter 11: Respiratory System

And Respiration

Respiration is a chemical reaction that breaks down food molecules in living cells to release energy. We always need to respire to perform lots of activities.

These include:



Muscle Contraction that enables us to move.

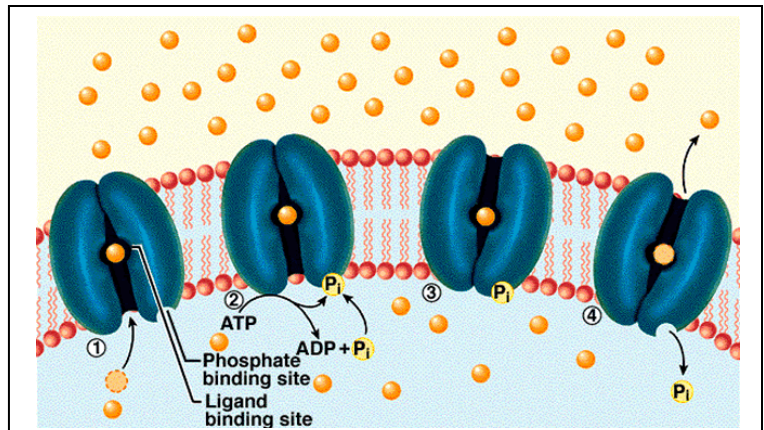

Active Transport in cells needs large amounts of energy



Producing heat inside the body to keep warm

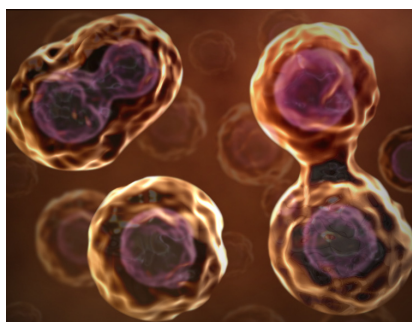

Cell division and growth

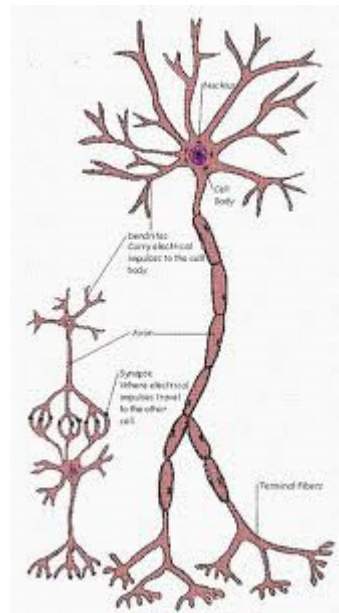

Passage of nerve impulses along nerve cells.

Human Respiratory System:

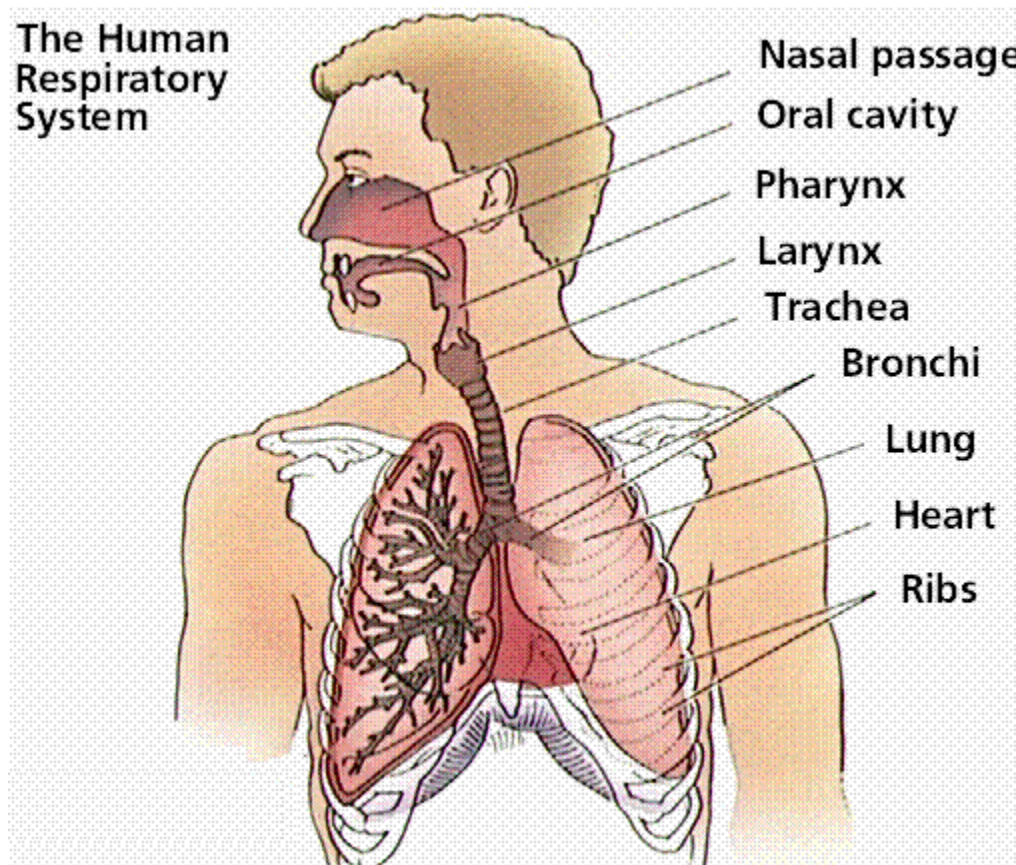

The human respiratory system is made up of air passages, lungs and the respiratory muscles.

Nose: most breathing and gas exchange occur through the nose. It is lined by a layer of mucus and hair to trap the dust and germs in the air. It is also supplied with a dense network of blood capillaries to warm the air entering the body.

Pharynx: Works together with the epiglottis to block the nasal cavity and the trachea during swallowing

food, to prevent it from entering the respiratory system.

Trachea (windpipe): this is a tube that connects the nasal cavity and larynx to the lungs. It is lined with a layer of ciliated epithelium cells and goblet cells which secrete mucus that traps bacteria and dust from inhaled air and gets moved upwards to the larynx by the cilia. It is then either spit out or swallowed to the stomach where it is eliminated by acid.

Bronchi: when the trachea reaches the lungs, it is divided into two tubes, one goes to the right lung and one goes to the left lung. These are called the bronchi. The bronchi are then divided bronchioles that extended deeper into the lungs.

Alveoli (air sacs): these are tiny bags full of gas, they are present in the lungs in large amounts (several million alveolus in each lung). They give the lungs a much larger surface area (about 70 m²) for faster diffusion of gases between them and the blood.

Rib Cage: the lungs are protected by this cage of bones. It surrounds all the thoracic cavity. They are 12 pairs of ribs, one pair extends from one of the first 12 vertebrae of the vertebral column. All of the ribs except for the last two pairs are connected to the sternum, the chest bone. Each pair of ribs is connected to the pairs above it and below it by muscle fibres called inter costal muscles. The rib cage and the lungs are separated by an elastic layer called pleural membrane, or pleura for short. It protects the lungs from damage caused by friction with the rib cage during breathing.

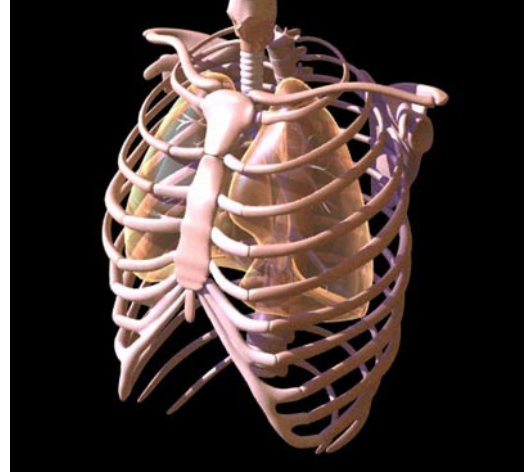

Diaphragm: this is a sheath of muscles that separates the thoracic cavity from the abdominal cavity. Together with the ribs and the inter costal muscles, it plays a big role in breathing and gas exchange.

Gas Exchange (Breathing):

Breathing is different from respiration. Breathing is just the exchange of waste gases from the body with fresh air from the atmosphere. The action of breathing

fresh air in is called **inhaling**, the action of breathing waste gases out is called **exhaling**.

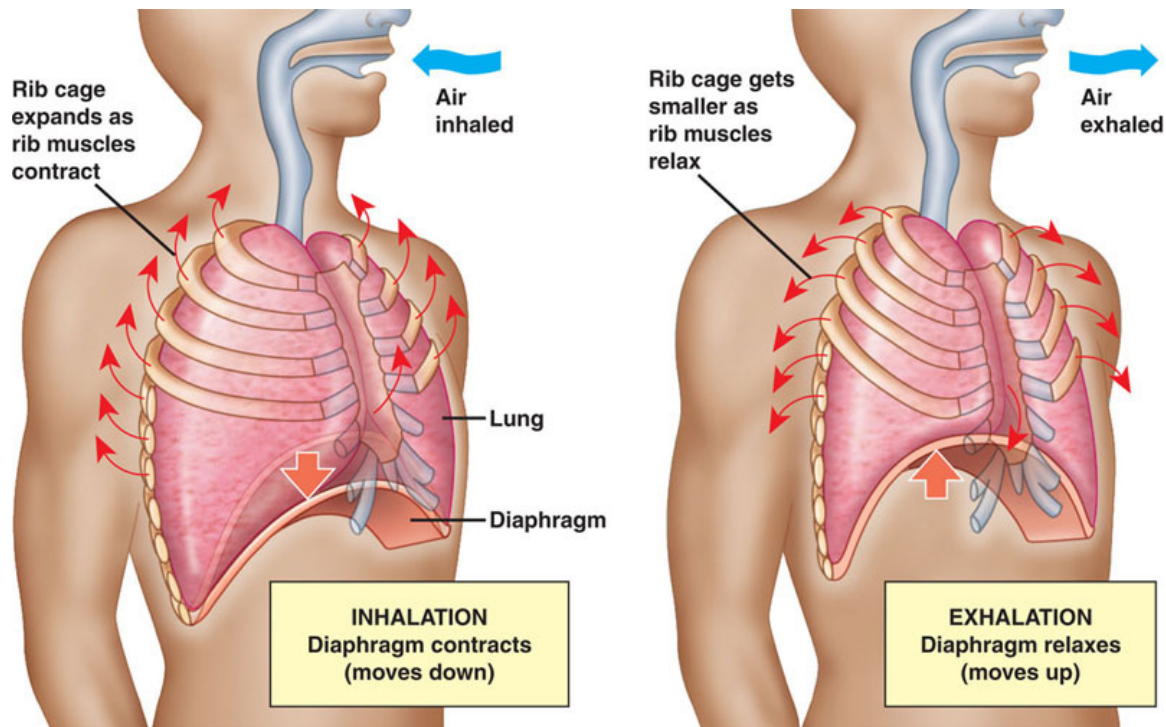

During **Inhaling** the brain sends electric impulses by nerves to the diaphragm and the inter costal muscles. The diaphragm contracts becoming flatter. The inter costal muscles also contract and move the ribs in an outer upwards directions. These actions expand the thoracic cavity making the lungs expand, thus increasing the volume, with the volume increasing the internal pressure decreases which makes air enter the lungs through the mouth, nose and trachea.

During **Exhaling**, the diaphragm and the inter costal muscles relax again, contracting the thoracic cavity

thus squeezing the air out of the lungs to the trachea and mouth and nose to the atmosphere.

Respiratory System In Action:

- **Inhaling occurs, air is absorbed by lungs, it enters the nose where bacteria and dust in it are trapped by mucus and warmed by blood capillaries. The air enters the trachea where it is cleaned again by cilia.**
- **The bronchi take the air from the trachea to each lung.**
- **Bronchi divide into several bronchioles, each one has a group of alveoli at the end of it.**
- **In the alveoli gas exchange takes place where the oxygen rich air diffuses into the blood capillaries of the pulmonary arteries and the carbon dioxide rich gas diffuses into the alveoli to be exhaled.**
- **The pulmonary vein carries the oxygenated fresh air to the heart where it is pumped to all the body cells.**

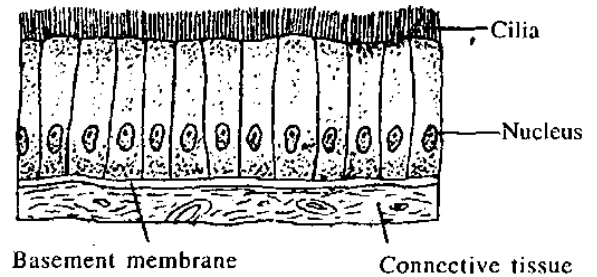

ZP-II c : Simple columnar ciliated epithelium

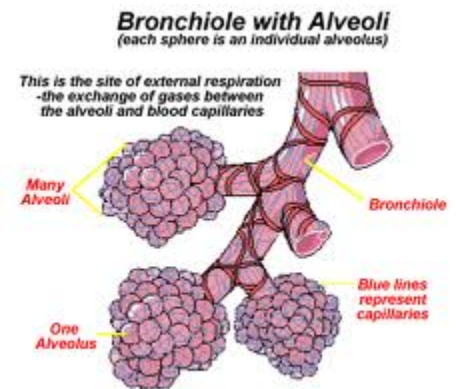

- The inter costal muscles and diaphragm relax squeezing the waste gases out of the lungs, this is exhalation.

Gas Exchange In Alveoli:

Each alveolus is supplied with blood capillaries. These come from the pulmonary artery and they contain deoxygenated blood rich in carbon dioxide. The concentration of oxygen is very high inside the alveolus and very low in the blood, so oxygen molecules diffuse from the alveolus to the red blood cells and combine with haemoglobin. At the very same time this occurs, carbon dioxide diffuses from the blood to the alveolus because the concentration of it is very high in the blood and low in the alveolus.

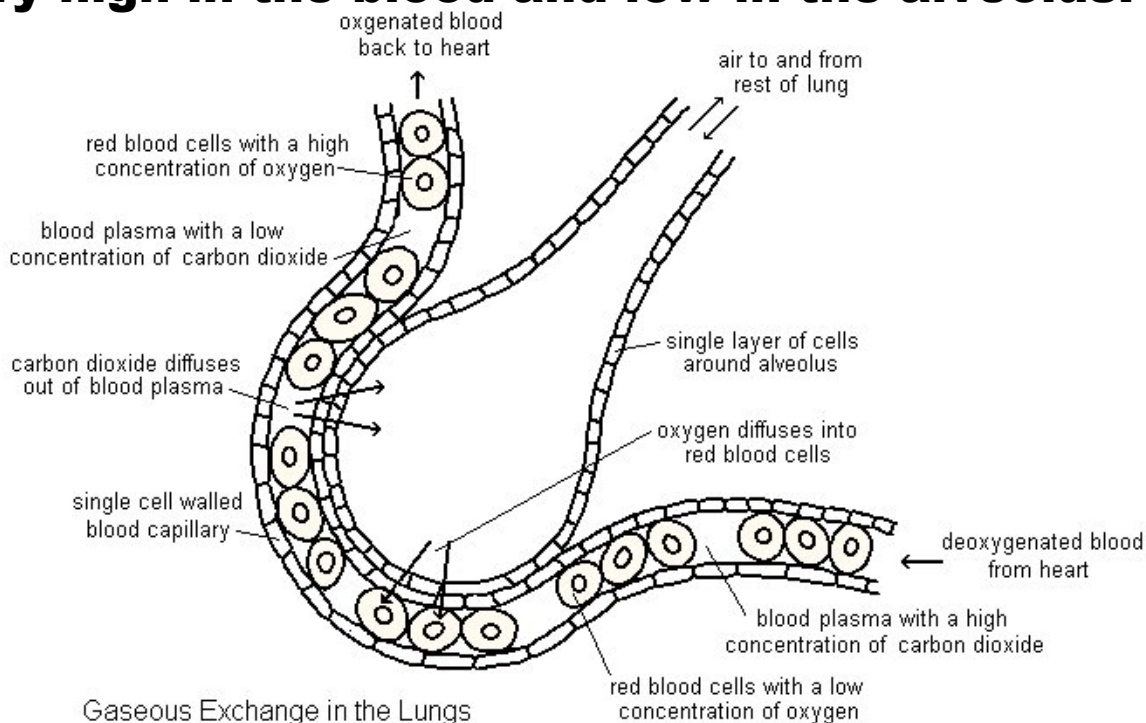

Adaptations Of Alveoli:

Gas exchange happens because of several factors in the alveolus and the blood capillaries that control the rate of gas exchange:

- **Very thin wall of both the alveolus and the capillary, they are one cell thick which makes the diffusion distance shorter, increasing the rate.**
- **The difference in concentration of gases between the alveolus and the capillary is very large, increasing the diffusion rate of gases.**
- **The alveolus are balloon shaped which gives it a very large surface area for faster diffusion.**
- **The walls of the alveolus are lined by a thin film of water in which gases dissolve in during diffusion, this makes it faster.**

Composition Of Inspired And Expired Air:

| Gas | Inspired Air | Expired Air |
|-----------------------|---------------------|--------------------|
| Oxygen | 21% | 16% |
| Carbon Dioxide | 0.04% | 4% |
| Nitrogen | 79% | 79% |
| Water Vapour | Variable | High |

Lung Capacity:

When lungs of an adult are fully inflated they have a volume of about 5 litres.

Tidal Volume: This is the volume of air breathed in and out at rest, this is 0.5 litres.

Vital Volume: The maximum volume of air that can be breathed in and out, at exercise for example. It is 3 litres.

Residual Volume: The lungs have to have a certain volume of air inside them all the time to keep shape. This is the residual volume and it is 1.5 litres. This air is renewed through breathing.

Aerobic Respiration:

A chemical, metabolic reaction that burns down glucose with oxygen producing carbon dioxide, water vapour and lots of energy

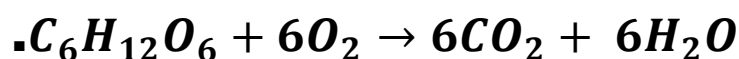

Aerobic Respiration: the release of relatively large amounts of energy in cells by the breakdown of food substances in the presence of oxygen.

Anaerobic Respiration:

Some organisms are able to respire and release energy when oxygen is lacking. This is anaerobic respiration. These are like yeast, bacteria and other organisms. Humans can also respire anaerobically for a short period of time. The amount of energy produced is much smaller than that produced during aerobic respiration though.

Anaerobic respiration: the release of relatively small amount of energy by the breakdown of food substances in the absence of oxygen.

Anaerobic Respiration I Yeast:

Yeast is able to respire anaerobically by breaking down glucose molecules into ethanol and carbon dioxide.

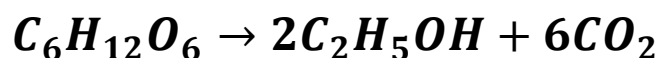

Ethanol is produced here, so it is a fermentation reaction. Remember that glucose is the only reactant.

Anaerobic Respiration in Humans:

When the amount of oxygen received by the muscle cells of the body is not enough to carry out all respiration aerobically, the cells respire anaerobically. But they cannot go like that for a long time. The anaerobic respiration in humans is different than that of yeast. Lactic acid is produced instead of ethanol, and no carbon dioxide is produced.

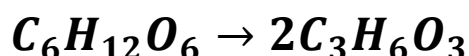

The lactic acid produced is very toxic and harmful to the body. That is why it has to be broken down with oxygen as soon as possible. This is called oxygen debt. Breaking down lactic acid releases energy too, if you add up the amount of energy produced during breaking down lactic acid and anaerobic respiration, you will find that it is the same as the amount produced during aerobic respiration.

Effects Of Smoking:

Short Term Effects:

- **Cilia can't vibrate anymore, the air inhaled isn't clean. Goblet cells release more mucus which makes the trachea narrower.**
- **Nicotine increases heart beat rate and blood pressure.**
- **Carbon monoxide combines with haemoglobin instead of oxygen combining with it. Carboxyhaemoglobin is formed which is stable. Less oxygen transported to cells.**

Diseases Caused By Tar:

Chronic Bronchitis:

- **Tar makes goblet cells in trachea produce excess mucus**
- **Mucus falls into lungs**
- **Bacteria in mucus breed causing infections like bronchitis**
- **The layer of excess mucus lining the walls of the alveoli increase the diffusion distance of gases making gas exchange slower**

www.studyguide.pk Emphysema:

- **The excess mucus lining the alveoli irritates it, causing strong coughs which damage the alveoli.**
- **The alveoli lose its shape and surface area making gas exchange much slower.**
- **This causes short breathes and sounds while breathing.**

Lung Cancer:

- **When tar reaches the lungs, it is absorbed by cells of the bronchi, bronchioles and the lungs.**
- **The tar causes excessive division and reproduction of these cells which develops into cancer**
- **The cancer can be spread to other organs too.**

Diseases Caused By Nicotine:

Coronary Heart Disease:

- **Nicotine helps cholesterol deposition on walls of coronary arteries. This causes atheroma.**
- **Carbon monoxide also increase risk of blood clots forming which might results in blocking the artery.**
- **Less oxygen is delivered to heart cells, a heart attack or failure can take place leading to death.**

Chapter 12: Excretion In Humans

Excretion is the removal of toxic materials, the waste products of metabolism and substance in excess of requirements from organisms. Metabolism is chemical reactions taking place inside cells, including respiration.

The body excretes three main waste materials. These are Carbon Dioxide, Urea and Water. Excretion is a very important feature to us because without it toxic substances will build up in our bodies and kill us. It also helps in maintaining the composition of body fluids.

The Excretory System of humans is made up of 4 structures: Two kidneys, two ureters, a bladder, and the urethra. The kidneys act as a filter to filter the waste products from the blood, the ureters are tubes that transport the main waste products (urine) from the

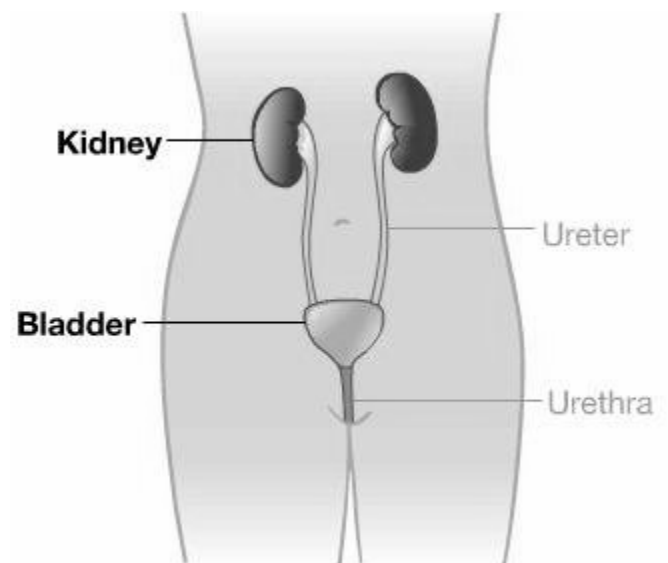

kidneys to the bladder, where it is stored until it is excreted out of the body through the urethra.

Formation Of Urea:

- **When you eat a food high in protein, it is digested in the small intestine into amino acids.**
- **The villi on the walls of the small intestine absorb the amino acids into the hepatic portal vein.**
- **Hepatic portal vein is a special vein that transports digested material from the small intestine to the liver.**
- **The liver plays a big role in maintaining the level of protein in our body. It absorbs all amino acids from the hepatic portal vein. If the body needs proteins, they will pass through the liver into the blood stream to be used by the body cells to make protein.**
- **If the body does not need proteins. The liver will absorb excess amino acids and break them down into carbohydrates and nitrogen. The formula of amino acids is CHON, here we remove the nitrogen from the molecule, to get a carbohydrate. This is called deamination. Nitrogen is made into urea which is a nitrogenous waste product.**
- **The products are then released to the blood stream.**

Kidneys Structure:

A kidney consists of two main Structures:

- **Cortex (outer layer)**
- **Medulla**

Between the cortex and the Medulla, there is a structure Called the **nephron.**

The nephron is the

Where filtration of toxic

Materials from the blood takes place. We have many of them in each kidney. In the centre of the kidney there is a cavity called the **pelvis which leads to the ureter.**

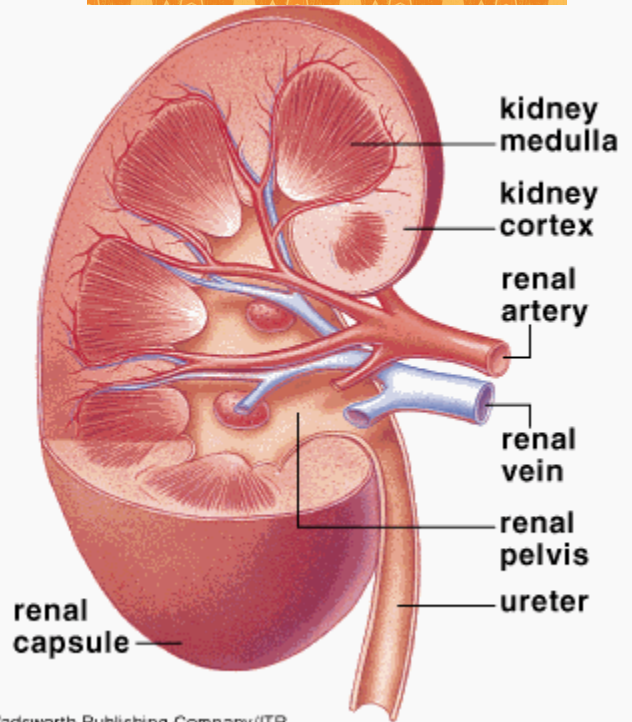

Structure Of Nephron:

The nephron starts with a cup shaped structure called **bowman's capsule**. Inside the bowman's capsule there is a very dense network of blood capillaries entering as capillaries from the renal artery and exiting as capillaries from the renal vein. This dense network of capillaries is called **Glomerulus**. The rest of the nephron is a long coiled tube where materials filtered from the blood flow in. At some point the coiled tube becomes straight and is bent in a U shape tube, this part is called **loop of Henle** and it is surrounded by a network of capillaries from the renal vein, it is where reabsorption takes place. All nephrones end at a large tube called the **Collecting duct** where content of the nephrones are transported to the pelvis, to be secreted in the ureter.

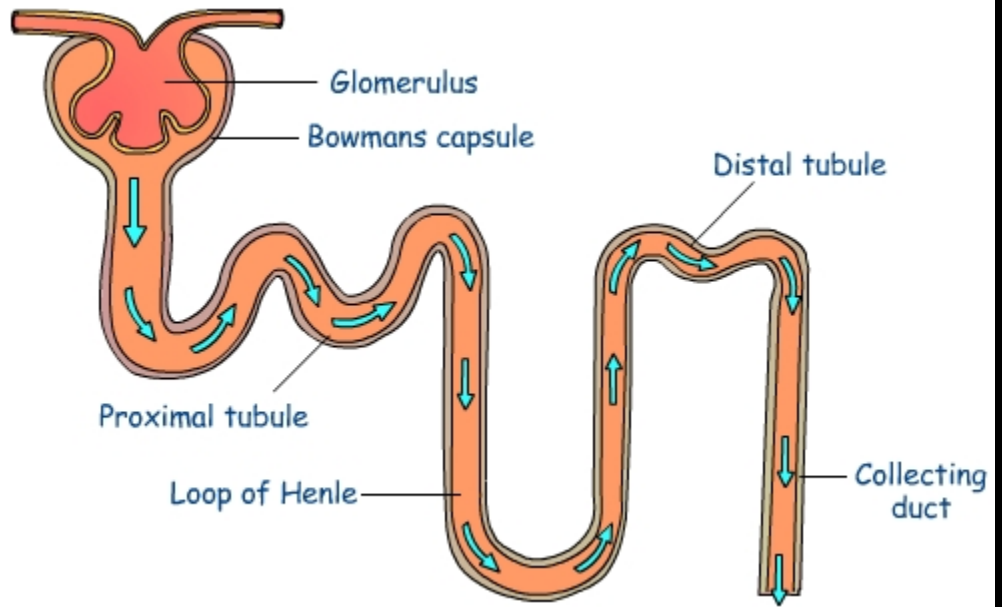

Mechanism of The Kidneys:

Ultrafiltration:

The blood in the renal artery contains large amounts of urea, glucose, water, mineral ions and some amino acids. When it reaches the glomerulus, the high pressure of the blood and the concentration gradient of these materials between the blood and the nephron cause most of these substances to diffuse from the blood to the Bowman's capsule and become content of the nephron, which is called glomerular filtrate (glomerular filtrate is a mixture of urea, water, glucose and mineral ions that diffused from the blood to the nephron).

Reabsorption:

The glomerular filtrate moves in the nephron till it reaches the loop of Henle, which is surrounded by a dense network of blood capillaries of the renal vein. Here there is a concentration gradient of the content of the content of nephron between the nephron and blood. Both diffusion and active transport occur to ensure the complete reabsorption of valuable substances from the glomerular filtrate back to the blood, these substances are glucose and amino acids.

Some water also move by osmosis to the blood, as well as minerals.

That leaves urea, excess water and minerals to continue in the nephron till it reaches the collecting duct and the pelvis. This mixture is called urine. Urine is transported from the pelvis to the urinary bladder by the ureters. It is then secreted out of the body through the urethra.

Dialysis:

If a person gets a kidney failure, which means his kidneys cannot function anymore, they have to wash their blood on regular basis with a machine that is an alternative to the damaged kidneys. This process is called dialysis. During this process, a tube is attached to the patient's vein, the tube is attached to the dialysis machine on the other end. There is another tube coming out of the machine to the patient's vein. the blood is sucked from the patient's vein, it goes through the machine, and out from the other side back to the patient's vein.

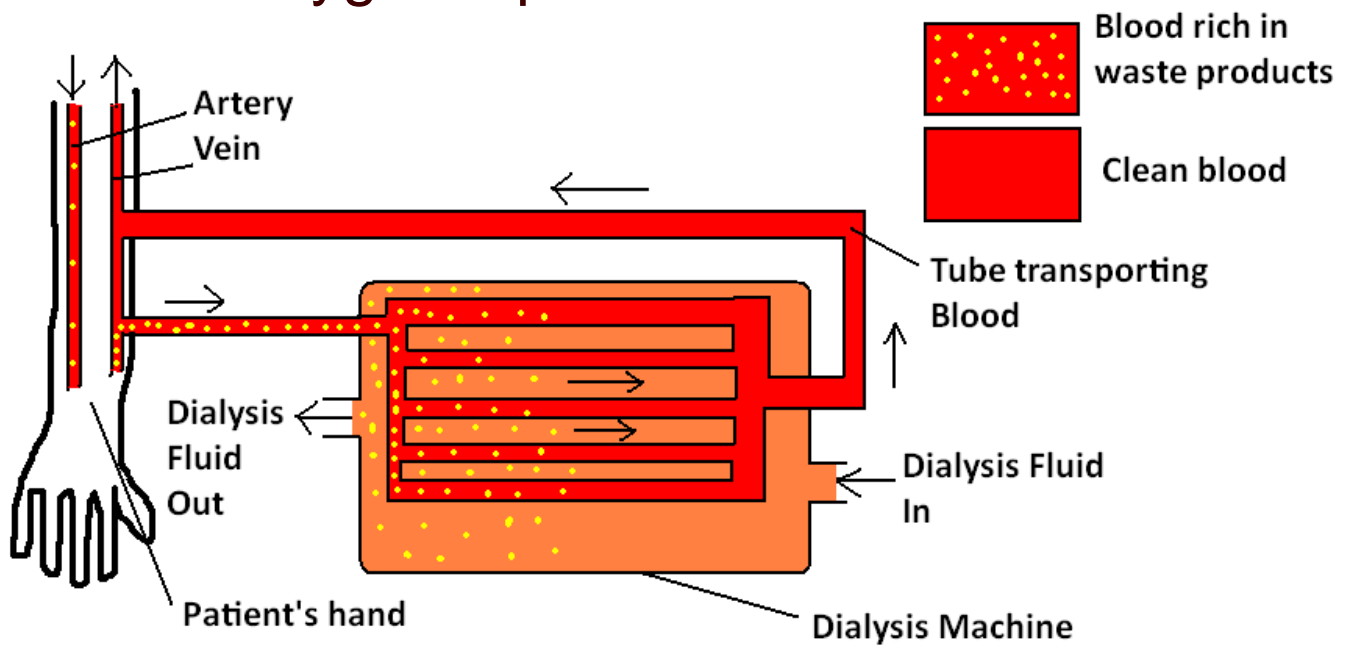

When the blood enters the dialysis machine, it is very rich in waste materials (urea, excess water and minerals). The tubes inside the dialysis machine are made of a partially permeable membrane to allow diffusion. The tubes are also surrounded with dialysis fluid which is the same as blood plasma. The concentration of waste products in the blood is much higher in the blood than in the dialysis fluid. This creates a concentration gradient, diffusion occurs and waste products leave the blood to the dialysis fluid, which then exists the machine and gets disposed. The dialysis fluid has to be renewed continuously to keep the concentration gradient of waste products higher in the blood, thus ensuring that all waste products leave

the blood. The clean blood is then returned to the patient's vein.

Chapter 13: Homeostasis:

The human body has the ability to maintain a constant internal environment so that every organ and cell is provided the perfect conditions to perform its functions. This is called homeostasis. There is no organ system for this function. However, every organ plays a role in maintaining a constant internal environment. For example the lungs are responsible for the supply of oxygen to cells. The liver is to maintain a constant level of glucose and amino acids, and so on.

Temperature Regulation:

A healthy human should have a body temperature of 37°C. If the body temperature drops below 37°C, metabolic reactions become slower because molecules move slower and have less kinetic energy. If the temperature rises above 37°C, the enzymes of the body begin to get denatured and metabolic reactions will be much slower.

Sometimes, the temperature of the area you are at is low enough to decrease your body temperature. Sometimes it is high enough to raise your body

temperature. This is why the body has the ability to control its body temperature. Our skin is responsible for this process.

The Human Skin:

The skin is an organ that coats your entire body. The skin is made up of two layers, the **Epidermis and the **dermis**.**

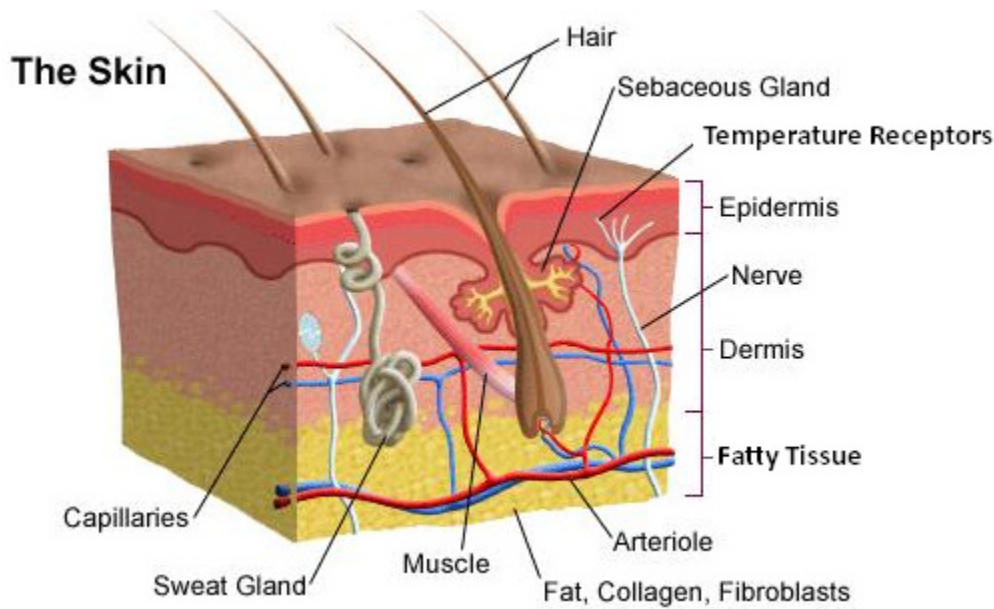

The epidermis's main function is to protect the dermis which contains most of the structures, and protect the body from ultra-violet rays. The surface of the epidermis is made of tough, dead cells.

The dermis contains many useful structures. Hairs, sweat and sebaceous glands, sense receptors and erector muscles are responsible for controlling the

body temperature. Blood vessels transport oxygen and nutrients to the cells of the skin.

A healthy body is continuously gaining and losing heat. Metabolic reactions like respiration release a lot of heat energy, muscular activity increase the metabolic rate and release more heat energy. The body can also gain temperature from the surroundings like the sun or by eating hot food. Heat is lost by the body through exposed skin by conduction. If there is sweat or water on the skin, it will absorb body heat to evaporate which drops the temperature. All these factors are normal however, but it is considered dangerous when the body temperature keeps on dropping or rising severely.

Cooling Down the Body:

When the body is overheated, the body takes several actions to drop it by trying to lose heat in several ways:

1. Vasodilation: this action causes the body to lose heat quickly. It involves widening the lumen of blood vessels of the skin, this increases blood flow and rate of heat loss. The vessels are also brought near the

surface of the skin to reduce the distance heat has to travel to escape.

2. Sweating: Sweat glands near the skin begin to secrete sweat on the surface of the skin through the pores. This sweat acts as a heat consumer to absorb the body heat and use it in evaporation. The activity of sweat glands is increased when the temperature of the body rises.

3. Hairs lie flat: The muscle erectors of the hairs relax making the hairs lay flat of the skin. When the hairs are erect, they trap air in the gaps between them, this acts as an insulation and prevents heat loss. But when the hairs are flat, less air is trapped between them so there is no insulation and more heat can be lost.

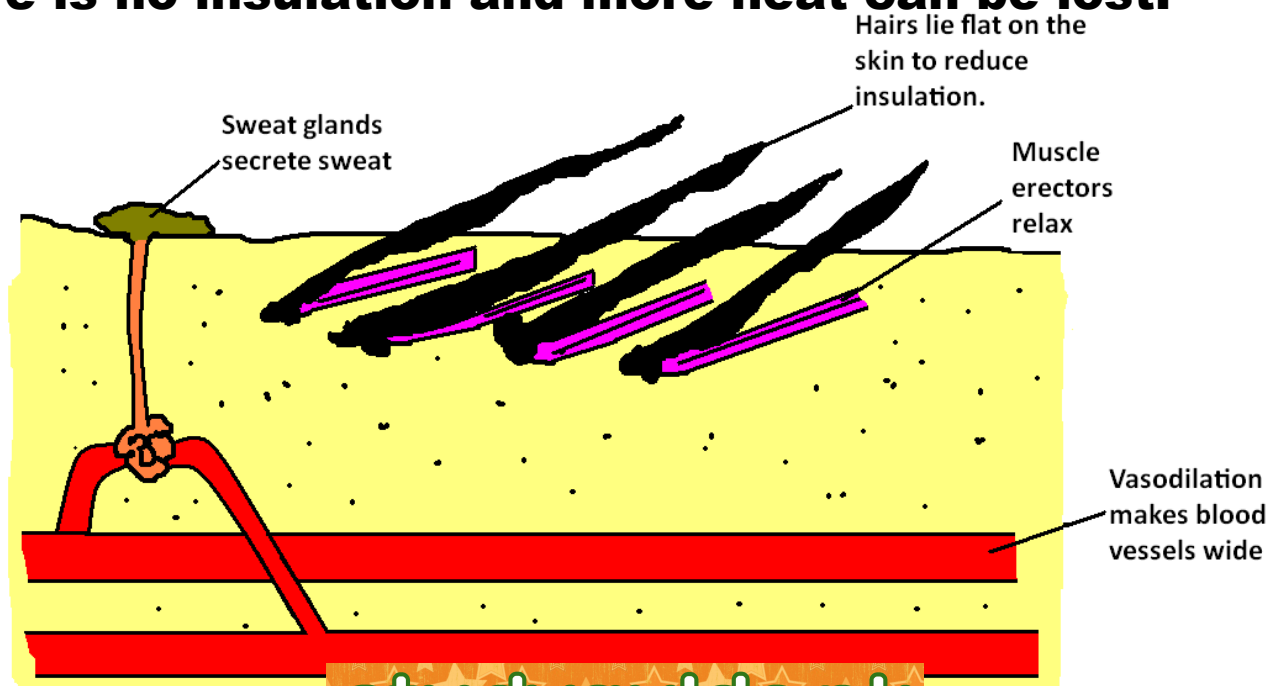

Heating Up the Body:

When the body temperatures drop, the body takes several actions to regulate its temperature by insulation to prevent heat loss and producing heat energy:

- 1. Vasoconstriction:** this causes the blood vessels to become narrower to reduce heat loss. They also sink deep into the skin to increase the distance heat has to travel to escape thus reducing heat loss.
- 2. Shivering:** the muscles in the limbs start to contract and relax rapidly, thus increasing the rate of respiration and amount of heat energy released by it.
- 3. Hairs become erect:** muscle erectors contract and make the hairs erect and stand up vertically trapping air in the gaps between them. This acts as insulation to reduce heat loss.

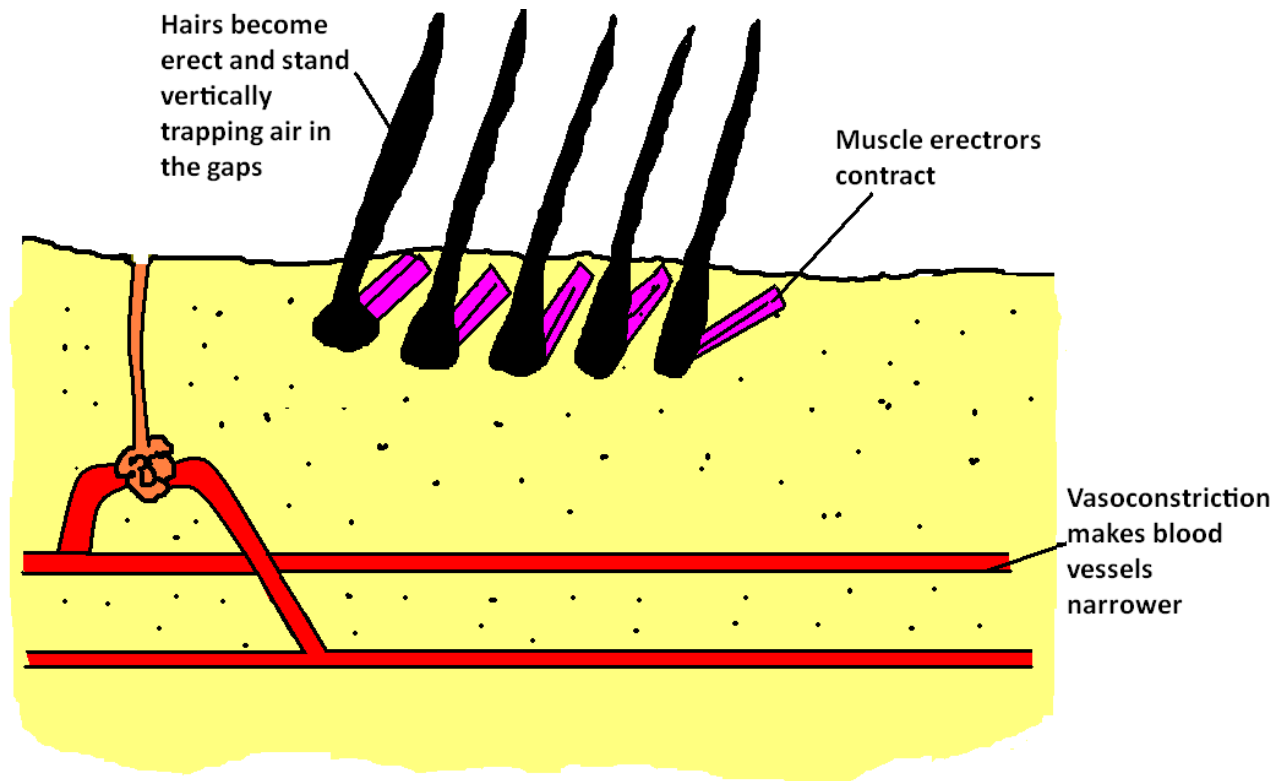

How the Body Senses Change in internal environment:

When the body's internal temperature changes the temperature of the blood changes with it. When the blood flows through the brain, a part of it called the **hypothalamus detects the drop or rise in temperature. The brain then starts sending electrical impulses to the rest of the body so that it works on heating or cooling its self.**

This process is called **Negative Feedback. Negative feedback is not for change in temperature only though, it is for any change in the internal temperature including the blood glucose level.**

Regulating Blood Glucose Level:

For blood glucose level however, the pancreas is the organ which monitors its level not the hypothalamus. When the blood flows through the pancreas, the pancreas detects the level of glucose in it. If it is higher than normal, the pancreas secretes a hormone called **insulin. Insulin flows in the blood till it reaches the liver. When it reaches the liver, insulin hormone will make it convert excess glucose in the blood into glycogen and store it in the liver cells. When the blood glucose level becomes normal, the pancreas will stop secreting insulin so that the liver stops converting glucose. If the blood glucose level decreases below normal, the pancreas secretes another hormone called **glucagon**. When glucagon reaches the liver, it makes the liver convert the glycogen it made from excess glucose back into glucose and secrete it into the blood stream so that the blood glucose level goes back to normal. When this happens the pancreas stops secreting glucagon.**

Normal Blood Glucose Level: 80-100 mg per 100cm³.

Chapter 14: Co-ordination and

Response:

You have previously learned that one of the 7 characteristics of living organism is **irritability** or sensitivity. And this is the ability to detect a change in the outer environment and respond to it. A change in the environment is also called a **stimulus** (plural stimuli). Actions taken by the body in order to cooperate with a stimuli are called responses. The body detects a stimulus by parts in the body called **receptors** and is able to respond to it through other parts called **effectors**. Two organ systems are continuously working to detect and respond to stimuli, these organ system are called the **nervous system** and the **endocrine system**.

The nervous system is a system of organs working together to detect and respond to stimuli. The nervous system is made up of two systems, the **central nervous system (C.N.S)** and the **peripheral nervous system (P.N.S)**. the peripheral nervous system connects the central nervous system to the other parts of the body.

Central Nervous System (CNS):

The central nervous system is made up of the brain and the spinal cord. The spinal cord is basically a big bundle of nerve cells running through a tunnel inside the backbone which protects it while the brain is protected by the skull. The central nervous system is what gives out orders to other parts of the body to perform certain jobs.

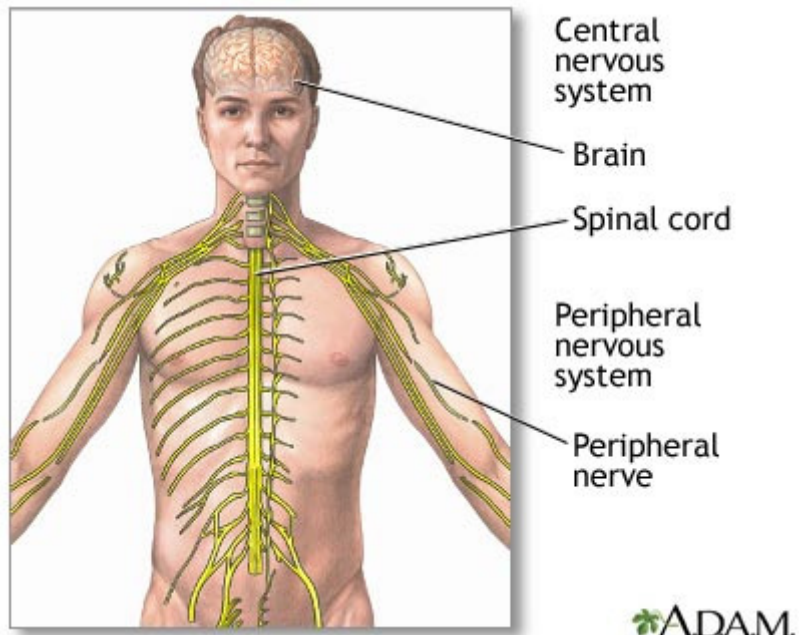

The Peripheral Nervous System PNS:

The peripheral nervous system is the other part of the nervous system. The main job of the PNS is to detect stimuli and send impulses to the CNS according to the stimuli. The PNS is made of receptors and nerves that carry the impulses.

Receptor cells are ones which's function is to detect something about its environment. There are many receptors in the body that are able to detect many changes like temperature, touch, light, sound and chemicals. There are some organs in the body that are there to detect just one stimulus, like the eye for example. These are called **sensory organs and they can be defined as a group of receptor cells responding to specific stimuli.**

Effectors are the opposite of receptors. Receptors are two detect the stimuli while effectors are two respond to it. Effectors are usually muscles and glands.

Neurons are one of the most important structures of the nervous systems. Neurons act as a wire that transmits electrical impulses all over the body. Like a cable that consists of many wires, a bundle of neurones is called a nerve. There are 3 types of neurones, each type is to transmit electrical impulses from a specific place to another.

Motor Neurone: This is a neurone that transmits electrical impulses from the Central nervous system to the effectors.

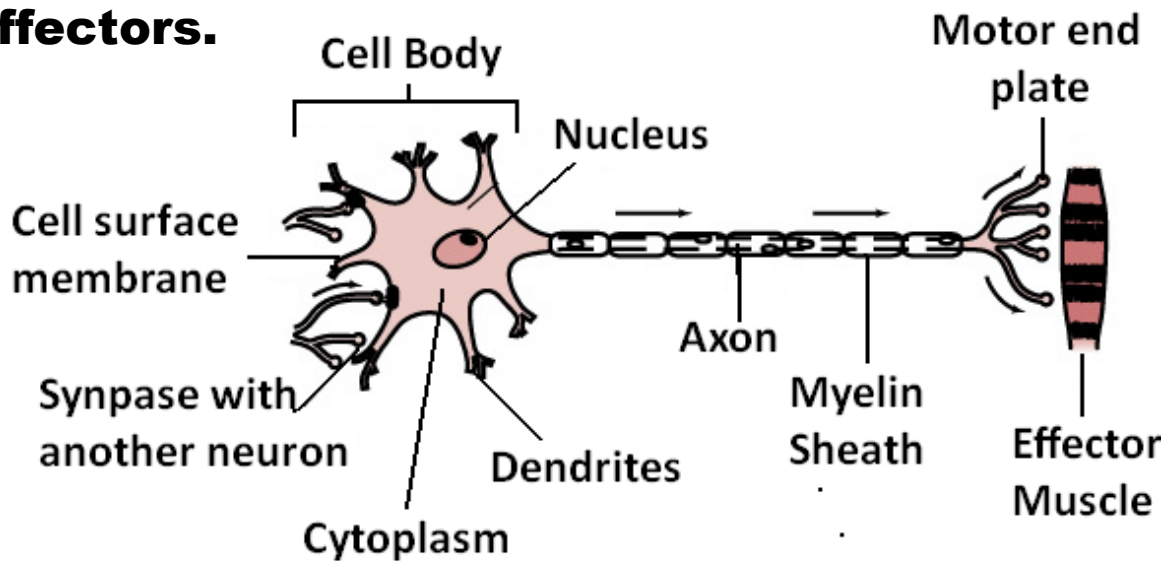

This neurone is made up of three segments; the cell body which is the start of the motor neurone and is in the CNS, axon which stretches out from the cell body all the way to end of the neurone, and the motor plate which is the end of the neurone and is in the effector muscle.

Neurones have features that are common between most animal cells like a nucleus, cytoplasm and cell surface membrane, but they also have some exclusive features like the **axon**. The axon is an extended cytoplasm thread along which electrical impulses travel. Some motor neurones have axons of length 1 metre. Axons are coated by a layer of myelin called **myelin sheath**, this is an electrically insulating layer which is essential for the proper functioning of the nervous system.

Another exclusive feature of neurones is **dendrites**, these are several short threads of cytoplasm coming out of the cell body. Their function is to pick up electrical impulses from other cells.

The last exclusive feature of motor neurones only is **motor end plate**. This is just the end of the axon which is in the muscle. It passes the electrical impulses from the neurone to the muscle fibres.

Sensory Neurones: like other neurones, sensory neurones carry electrical impulses from one place to another. But sensory neurones carry electrical impulses in the direction different to that of motor neurones, from the receptors to the CNS.

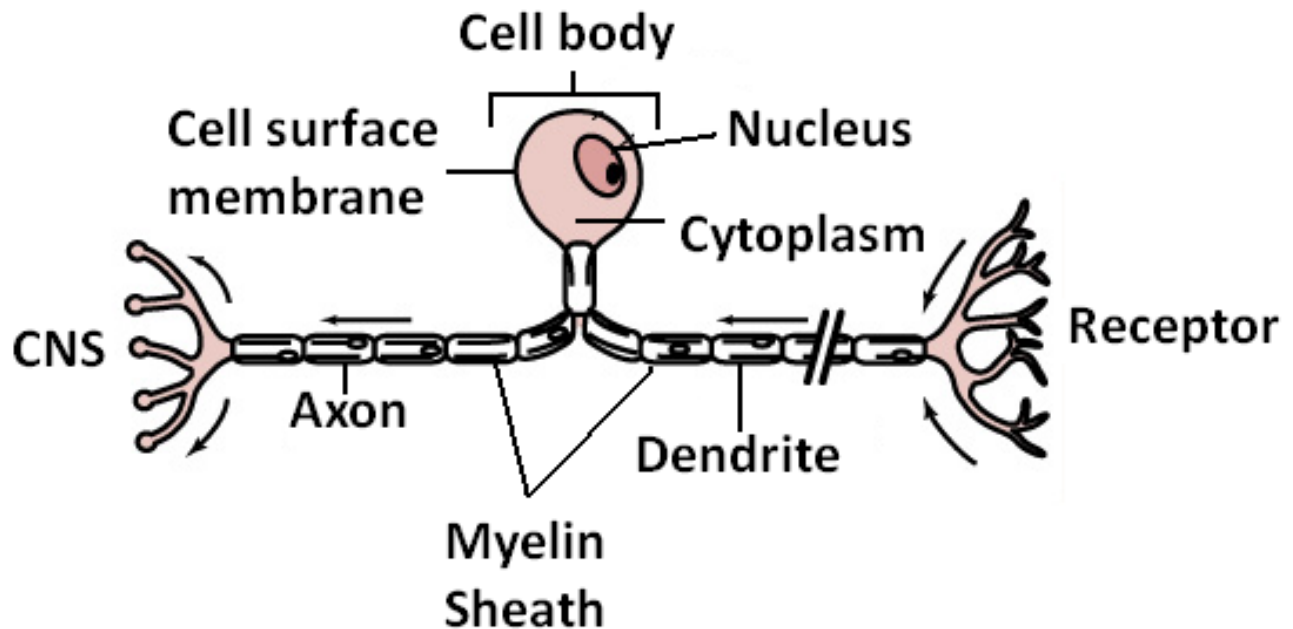

The sensory neurone's shape is unique. This is because it is made of a cell body, with two arms extending out of it. The first arm is the axon which's other end is in the CNS. The second arm is dendrite which's other end is in the receptor. The dendrite is similar in structure to the axon except that it joins the receptor with the cell body. The electrical impulses of the sensory neurone flow from the receptor, through the dendrite to the cell body, then from the cell body to the CNS through the axon.

Relay Neurone: Relay neurones are located in the CNS.

Their job is to pass electrical impulses from the sensory neurone onto the motor neurone, so it acts like a diversion.

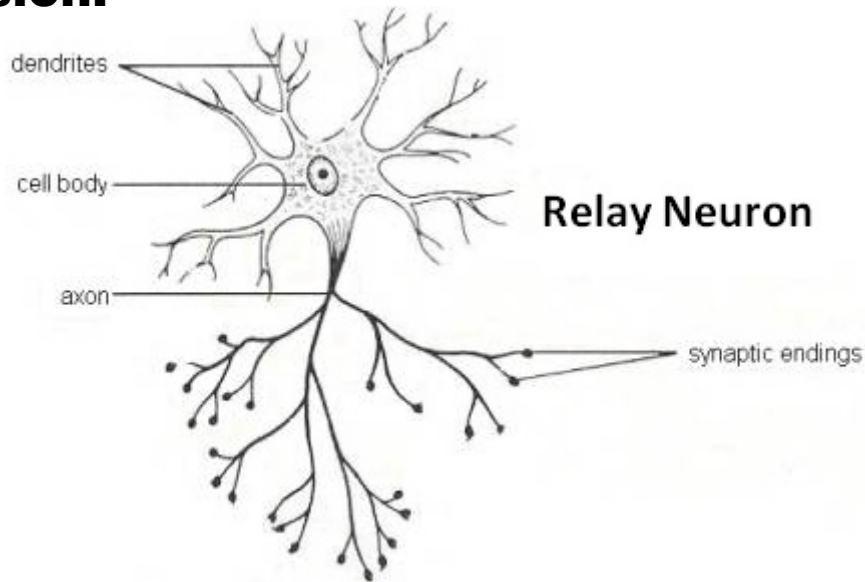

Where neurones meet, they are not actually touching each other. Instead there is a gap called synapse or junction box. When the electrical impulses reach the end of a neurone, the neurone secretes a chemical transmitter which passes by diffusion to the other neurone causing the impulses to be carried from the first neurone to the second.

Reflex Arc (Nervous System in Action):

If your finger touches a hot surface, receptor cells in the skin of your finger detect a stimulus, which is a sudden rise in the temperature. The receptor uses the energy of the stimulus to generate electrical impulses. These impulses are then carried by the axons of the dendrites of the sensory neurone through cell body to axon and from the axon to the CNS. At the CNS the electrical impulses travel through the synapse to the relay neurone, which passes it onto the motor neurone. The nerve impulses are transmitted through the axon of the motor neurone to the targeted muscle which contracts when electrical impulses reach it, resulting in your finger being pulled away from the hot surface. This pathway is called the **reflex arc** and happens in about a fraction of a second.

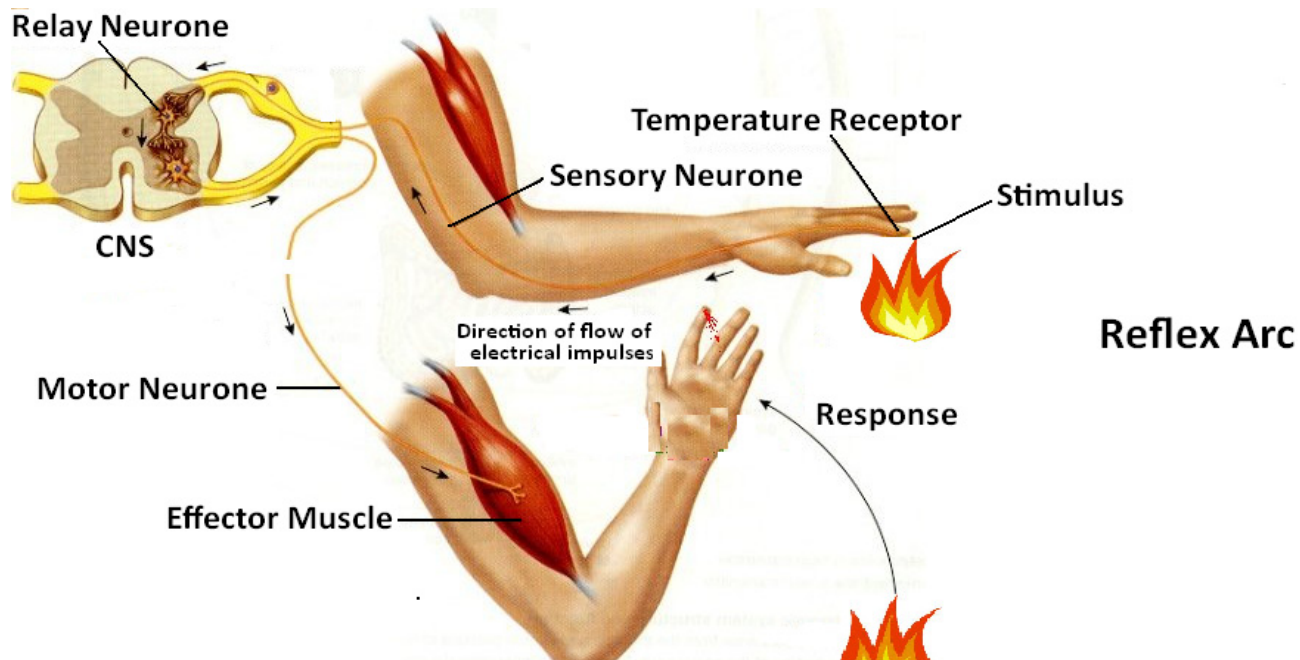

Reflex Arc:

RECEPTOR → Sensory Neurone → CNS →
Motor Neurone → EFFECTOR

Voluntary and Involuntary Actions:

The reflex arc is a reflex action. Reflex means it is automatically done without your choice. This is because when the electrical impulses reach the relay neurone in the CNS from the receptors, some impulses are carried by other neurones to the brain, and some impulses are passes onto the motor neurone to the effector muscle and the response takes place. The electrical impulses going to your brain are much slower that the ones going to the effector muscle directly. This is why the reflex action takes place before you realise it, it is uncontrollable. Reflex actions are said to be **involuntary actions. Involuntary actions start at the sense organ heading to the effector. They are extremely quick. **Voluntary actions** are the ones that you make the choice to do. Like picking up a bag from the floor for example. Your brain sends electrical impulses to the effector muscles ordering them to contract so you could pick the bag**

up. Voluntary actions are slower than involuntary actions and they start at the brain.

The Human Eye:

The human eye is a sensory organ. This means it is an organ of tissues working together to detect and respond to a specific stimulus, which is light.

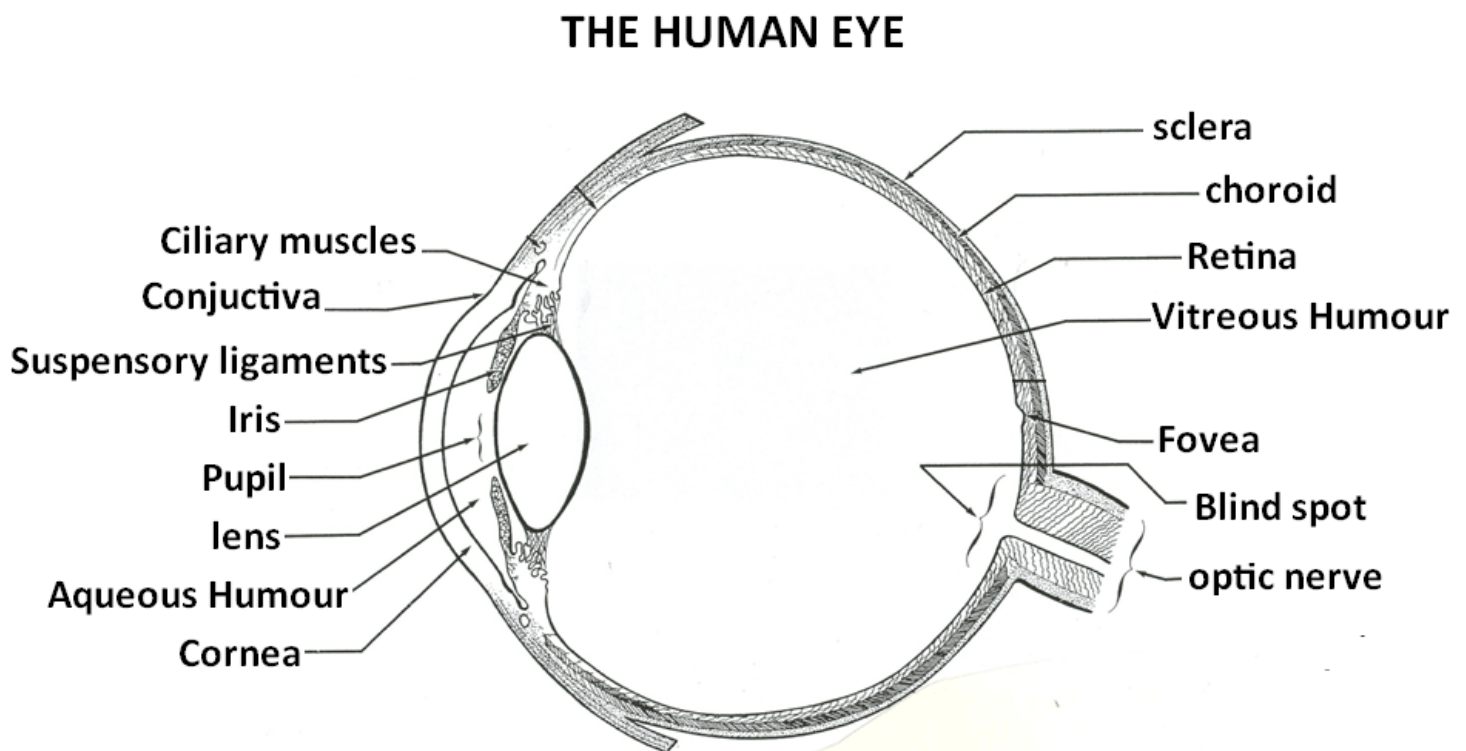

Features of the Human Eye:

- **Lens**: changes shape to focus light on retina
- **Ciliary muscles**: contracts and relaxes to adjust thickness of the lens
- **Suspensory ligaments**: loosens and tightens to adjust thickness of lens
- **Iris**: widens and narrows to control amount of light entering the eye depending on light intensity
- **Choroid**: middle layer surrounding the eye. It contains many blood vessels
- **Sclera**: outer most tough, protective layer of the eye.
- **Retina**: inner most layer. It is sensitive to light and it is where the fovea is and it has rods and cons
- **Fovea**: very light sensitive spot
- **Blind spot**: Where the optic nerve touches the eye. No light sensitive cells in this area

How We See:

When the light hits an object, it is reflected in all directions. When a light ray reflected from the object hits your eye you see that object. At the back of your eye, there is a spot on the retina called the fovea (blind spot). This spot is full of light sensitive cells. When the light ray falls on the fovea, the light sensitive cells generate electrical impulses that travel through the optic nerve to brain. When the electrical impulses reach the brain, the brain generates the image you see. This all happens in less than a fraction of a second.

But this is the general idea only. Light rays enter the eye from every direction. If they are not focused on the fovea, they will most probably not hit it and we won't see. Here comes the role of the front part of the eye. When the light ray hits the eye at an angle, it first has to penetrate the cornea which refracts (bends) the light ray inwards. The cornea acts as a converging (convex) lens. Then the light penetrates the lens which refracts the ray a little more inwards focusing the light ray on the fovea. And

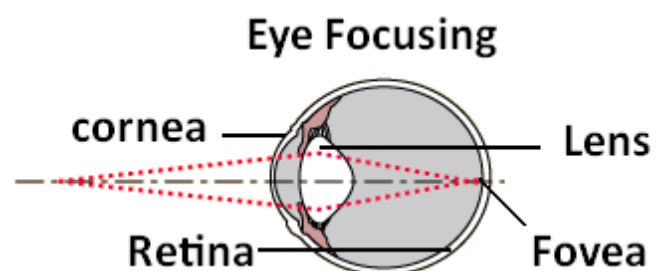

thus the light ray is focused on the retina. when the ray hits the retina, the closer to the fovea the sharper the image is.

Accommodation:

The angle at which the light ray hits the eye depends on the distance of the object. Every light ray that hits the eye needs a certain amount of refraction in order to be directed to the fovea. This is why the lens has the ability to widen and narrow according to the distance of the object you're looking at in order to make the light ray hit the retina at the right spot. This is called accommodation. Light rays refracted from close objects are diverging (spreading out), they need to be refracted inwards to be focused on the fovea. When you look at a close object, it takes some time till the vision becomes clear. This is because at first, the light ray is not correctly refracted, so it hits the retina away from the fovea. The electrical impulses are generated and sent to the brain which realises that the image is not clear. The brain then sends electrical impulses to the ciliary muscles making them contract. When the ciliary muscles contract the suspensory ligaments become loose, this makes the lens become thicker and rounder for more refraction of the light

rays. Now the light rays are correctly refracted and hit the retina at the fovea, the image becomes clear.

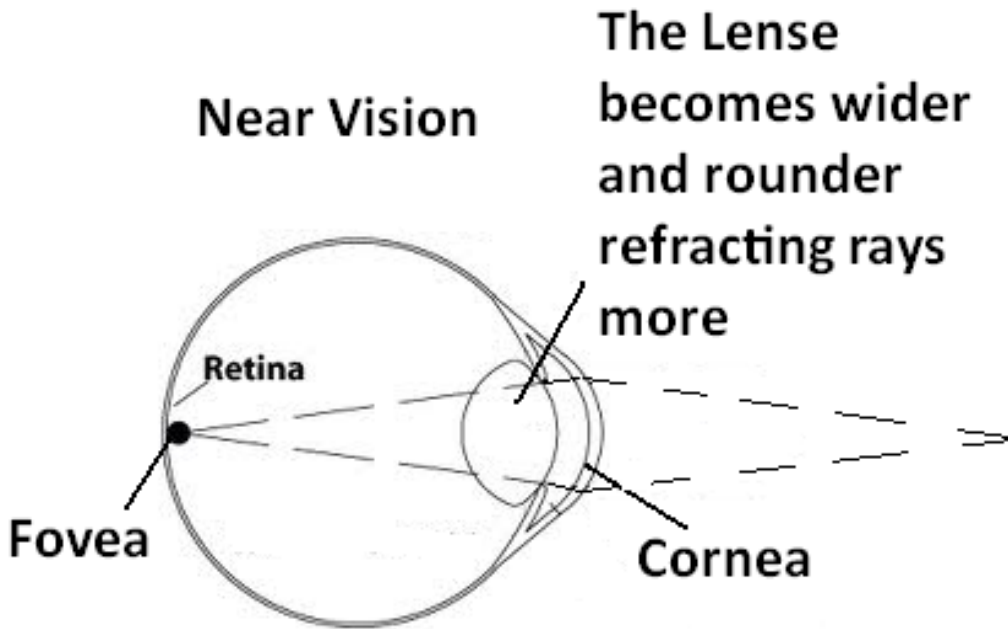

For far visions it is the exact opposite. The rays reflected from far objects are almost parallel. Very little refraction should be done. The brain sends electrical impulses to ciliary muscles making them relax, the suspensory ligaments now tighten up and pull the lens which become narrow.

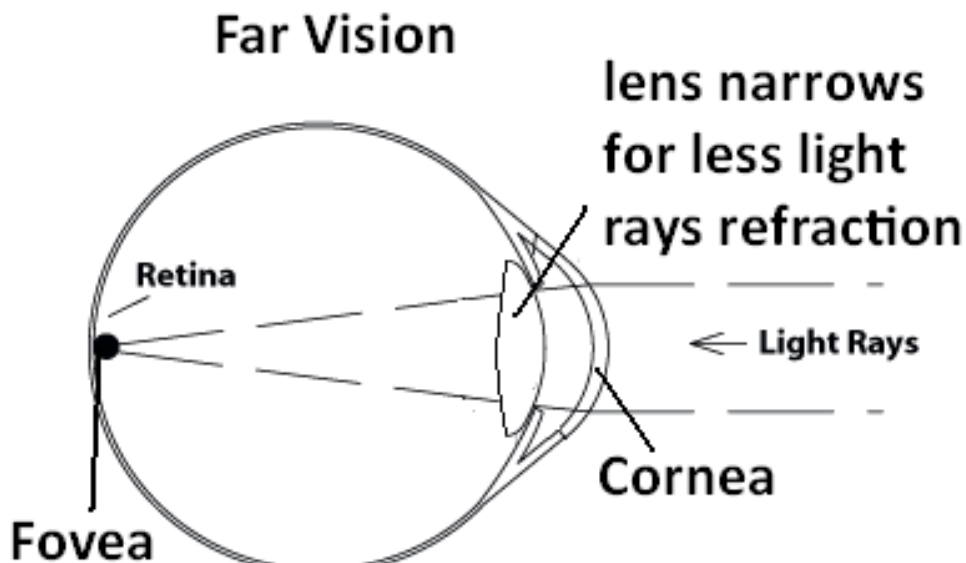

| Distance | Ciliary muscles | Suspensory ligaments | Lens |
|-----------------|------------------------|-----------------------------|----------------|
| Near | Contract | Loosen | Widens |
| Far | Relaxes | tighten | narrows |

Rods and Cones:

The retina is full of light sensitive cells called photoreceptors. There are two types photoreceptors, they are rods and cones. Rods and cones are specialised types of neurons. They look alike but they are a little different in function.

Rods are sensitive to dim light. At night or in dark places, most light detection electrical impulses transmission is done by rods. Vitamin A is essential for proper functioning of rods, if Vitamin A lacks it can lead to night blindness. Rods are spread all over the retina.

Cones are sensitive to bright and coloured light. All cones are packed in one area, the fovea.

The Pupil:

The pupil of the eye is the dark round area in the centre of it. It is surrounded by a coloured ring structure called the iris. The pupil and the

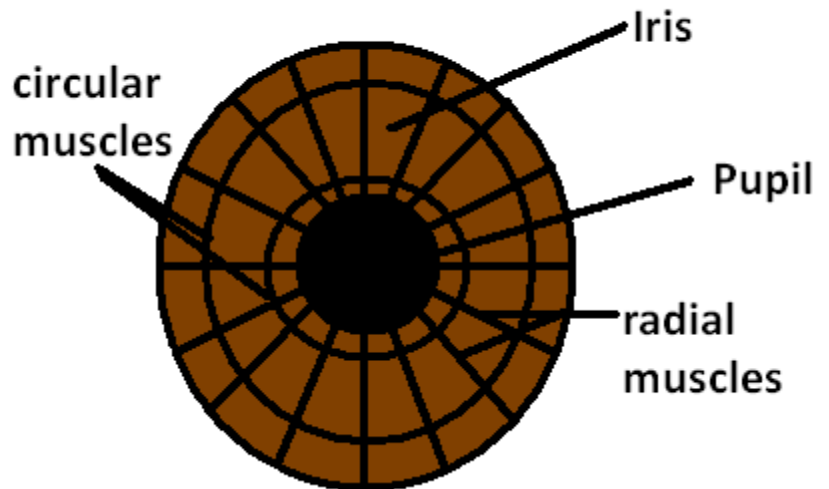

together play a big role in protecting the eye from damage by limiting the amount of light entering the eye. If too much light fall on the retina, the rods and cones get damaged. The iris and pupil change their size to stop that happening. The iris contains two sets of muscles: **circular** and **radial muscles**. Circular muscles run around the iris and radial muscles run from the centre to the outside. When circular muscles contract they make the pupil smaller. When the radial muscles contract the stretch the pupil outwards making it wider.

In bright light, too much light starts entering the eye, which is dangerous for the rods and cones, which detect the high light intensity. The rods and cones start a reflex arc by sending electrical impulses to the brain via sensory neurone. The brain responds by

sending electrical impulses to the muscles of the iris via motor neurone. These impulses make the circular muscles contract and the radial muscles relax limiting the amount of light entering the eye, thus protecting the rods and cones from damage.

If you walk into a dark room, the rods and cones sense the little amount of light. They start another reflex arc and send electrical impulses to the brain which responds by sending electrical impulses the muscles of the iris. The radial muscles contract and the circular muscles relax widening the pupil to let more light in.

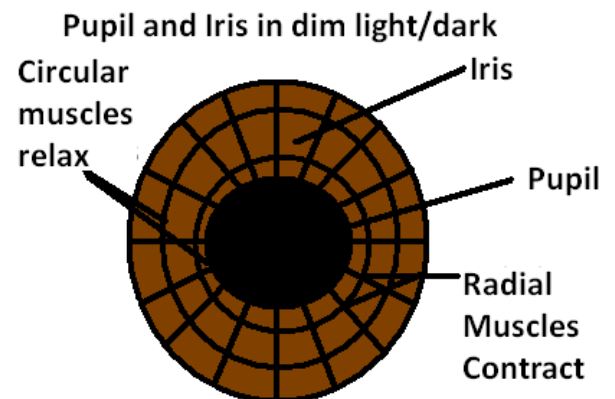
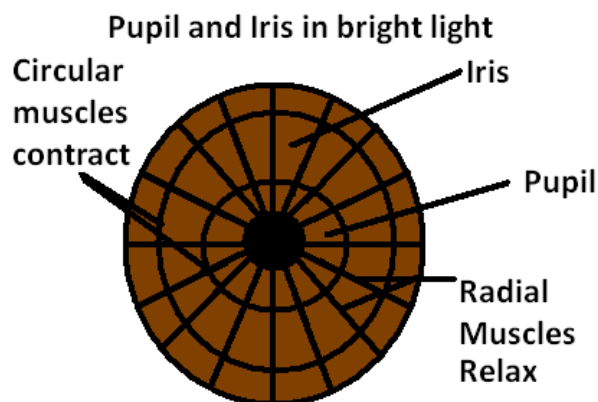

You have just learned that in order for the pupil to get narrower or wider, two muscles work simultaneously, when one contracts the other relaxes. Pairs of muscles like that are called antagonistic muscles.

The most known antagonistic muscle pair is the biceps and triceps of the arm. The bi and the tri for short, they are what causes the movement of the arm. They work simultaneously to bend or straighten the arm. The biceps is located in front of the humerus bone of the upper arm. The biceps is joined to the radius bone of the lower arm and the triceps is joined to the ulna bone of the lower arm. Muscles are attached to bones by strong fibres called tendons.

When you want to bend your arm the brain send two electrical impulses, one to the bi making it contract and one to the tri telling it to relax. When the bi contracts, it becomes shorter pulling the bones to which it is attached close and bending the arm. This causes the fibres of the tri to stretch while they are relaxed.

To straighten your arm, the brain sends electrical impulses to both muscles making the biceps relax in order to leave the muscle it is attached to free. The triceps contracts and becomes shorter pulling the muscle it is attached to into place and straightening the arm.

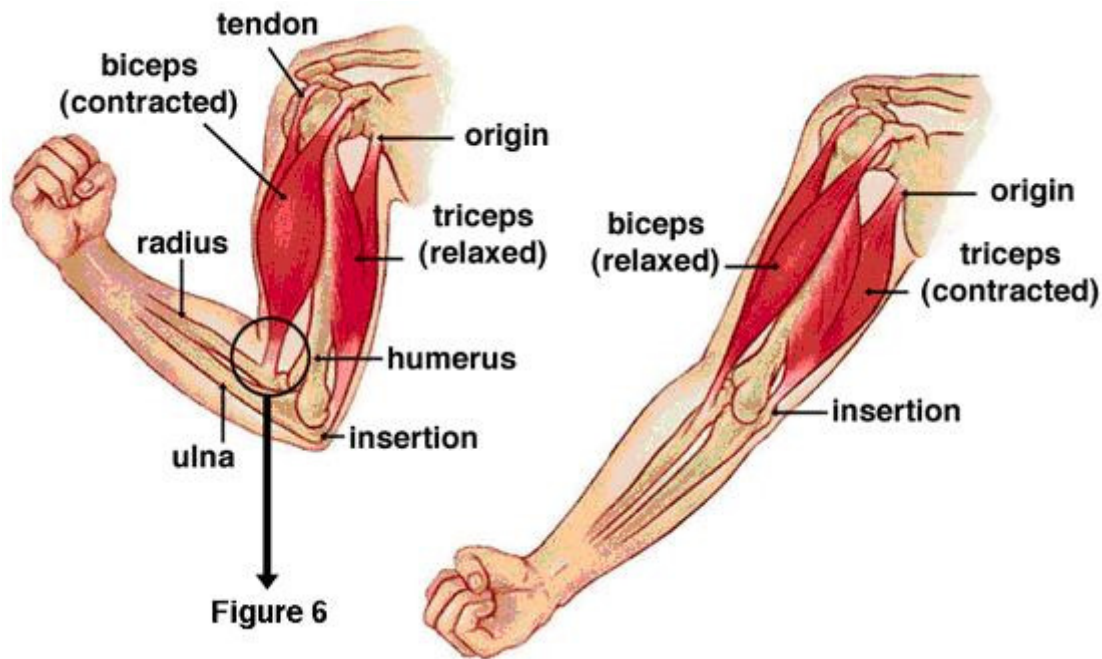

The biceps can be called a flexor because it flexes (bends) the arm. The triceps can be called an extensor because it extends (straightens) the arm.

Drugs:

A drug is a chemical substance that modifies and affects chemical reactions of the body when taken in. Many drugs are useful to us like antibiotics, painkillers and caffeine.

Some drugs however are abused by users to feel relaxed, or reach euphoria. Euphoria is a state of mind at which the abuser feels extremely happy and relaxed. These drugs include alcohol and heroin.

Alcohol:

Alcohol is a depressant drug. This means that it reduces the activity of the brain and slows down the nervous system and reflex actions. Alcohol can be extremely dangerous when the user is in a situation in which they need fast reflex actions.



Alcohol is addictive. The more you drink it the more you need it. The user may reach a point where they cannot do without alcohol, this is when they become alcoholics. Alcohol is broken down into fats by the liver. If the abuser drinks too much alcohol, the cells of the kidney may die shortening their life.

Heroin:

Heroin is a narcotic drug. This means that it relieves pain and induces sleep. Heroin is extracted from a plant called opium poppy. Most heroine abusers become addicts. For the addicts heroine become the number one priority in their lives. They would do anything to get the drug even become criminals and possess a threat to their society. If not rehabilitated, a heroine abuser will end up homeless or dead. Some heroine users inject the drug in their veins by an unsterilized, shared needle, this increases the risk of getting AID/HIV.

The Endocrine System:

You have previously learned that messages are delivered around body as electrical impulses by the nervous system. Another way messages are transported around the body is by chemicals called **hormones secreted by the endocrine system.**

Hormones are chemical substances produced by a gland, carried by the blood, which alters the activity of one or more specific target organs and is then destroyed by the liver.

Hormones are produced in organs called **endocrine glands** which make up the endocrine system. The following diagram shows the glands of a human body:

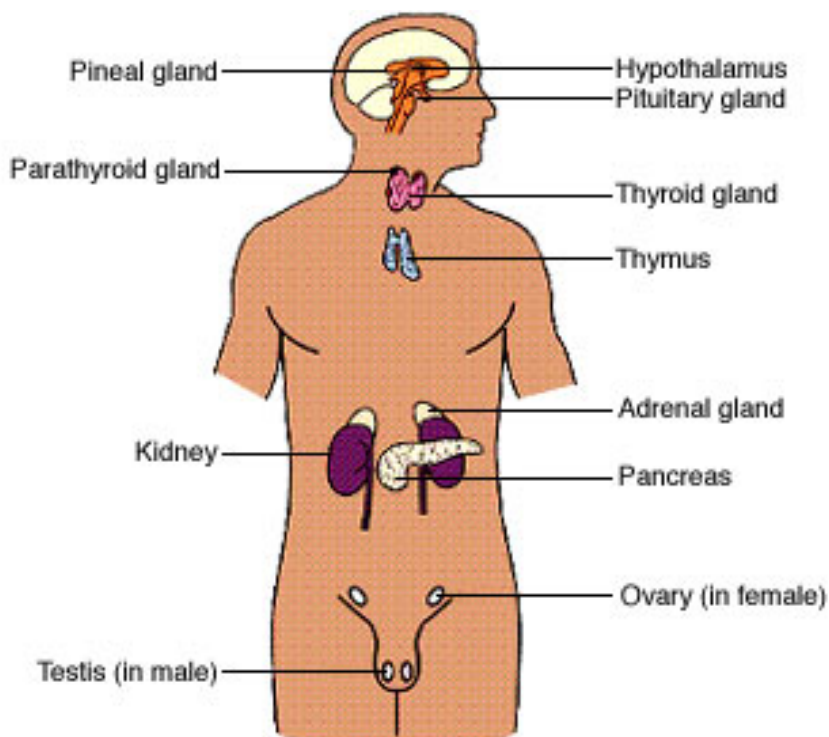

Glands are organs made of secretory cells which's function is to produce hormones and secret them into the bloodstream. Glands have a dense network of blood capillaries in them to secret the hormones in. hormones are carried around the plasma like all other content of the blood but certain organs are able to use them, these are **target organs.**

| Gland | Hormone produced | Function of hormone |
|----------------------|-------------------------|---|
| Adrenal gland | Adrenaline | Prepares the body for activities that need energy and quick reflex actions |
| Pancreas | Insulin | Makes liver reduce blood glucose level |
| | Glucagon | Makes liver increase blood glucose level |
| Testis | Testosterone | Produces male secondary sexual characteristics |
| Ovary | Oestrogen | Produces female secondary sexual characteristics |
| | Progesterone | Helps control menstrual cycle and maintain pregnancy |

Adrenaline:

When you get a fright you feel some changes in your body like a sudden increase in heart beat rate, blood flowing quickly in veins and your breath becomes deeper and faster. This is because the fright you got caused the brain to send electrical impulses to the

adrenal glands making them secrete adrenaline hormone in your bloodstream. Adrenaline is a hormone that is secreted from the adrenal glands to prepare the body for situations that need lots of energy and fast reflex action, like fights or running away for example. Adrenaline's main objective is to increase your metabolic rate so that you have enough energy for fighting or running away etc. This is why adrenaline is called the three Fs hormone (Fight, fright, flight). One of adrenaline's target organs is the heart. When adrenaline reaches the heart it causes the cardiac muscle to contract and relax much rapider so that oxygen and glucose reach the muscles of the body faster. Adrenaline also makes the liver convert glycogen into glucose and secret it in the blood to be used in respiration. When adrenaline reaches the diaphragm and the intercostals muscles of the ribs, they make it contract and relax faster too to increase rate of breathing. These changes cause an increase in the respiration rate so that lots of energy is being released. Generally, adrenaline is secreted when you are nervous or anxious.

Use of Hormones in Food Industries:

Technologies and science have advanced enough that we can now get much more money out of farming and animal keeping. Hormones are now being used in farms to increase milk yields in cows and growth rate in cattle and fish.

In farms, the cows are being injected with a hormone called Bovine Somatotropin or BST. BST is a hormone that is naturally produced in cows. The function of BST is to produce milk. Injecting cows with extra BST will boost milk production and bring in more money for the farmers. Some people however are against the use of BST and claim it is safer for both the cows and the consumer to keep it natural and keep more cows if we want an increased milk yield.

Growth hormones are also being mixed with the food fed to cattle to increase their growth rate and make them grow larger. But again many people are against this and prefer buying meat and fish that were naturally grown.

Comparing Nervous and Endocrine Systems:

| <u>Nervous System</u> | <u>Endocrine System</u> |
|--|---|
| Information sent in form of electrical impulses | Information sent in form of chemical hormones |
| Information travel neurones | Information travel in bloodstream |
| Information travels extremely rapidly | Information travels relatively slow |
| Information is headed to one target (effector) | Information may be used by several targeted organs |
| Electrical signals have an effect that ends quickly | Hormones have a longer lasting effect |

Coordinates and Responses in Plants:

Plants cannot move themselves to areas of preferable conditions. This is why plants have the ability to detect a stimulus and respond to it by growing or bending in its direction or away from it. These responses are called **tropisms. For example a plant tends to grow its stem in the direction of sunlight for more photosynthesis, this is a tropism. There are two types of tropism, these are **phototropism** and **geotropism**.**

Phototropism: the response in which a plant grows towards or away from the direction from which light is coming.

Geotropism: the response in which a plant grows towards or away from gravity.

A tropism can be either positive or negative. If a tropism is in the direction of the stimulus, it is positive. If the tropism is away from the stimulus it is negative.

For example, a plant's shoot tends to grow in the direction of sunlight, this is positive phototropism. But the plant's root grows in the opposite direction deeply into the soil, this is negative phototropism. However, positive phototropism can also be described as negative geotropism because it involves the plant growing in the direction opposite to gravity. And negative photo tropism can be described as positive geotropism because it involves the plant growing towards gravity.

Tropisms are controlled by a chemical called Auxin. Auxin is a plant hormone. It is produced by cells at the tip of roots and shoots of plants. At the tip of a shoot, there is an area in which cells are being produced by dividing so that the shoot grows. Old cells do not divide, but they grow longer instead. The growth of these cells longer is controlled by auxins. Auxins is what makes the plant grows this is why a plant doesn't grow if you cut it's tip off.

Auxins' Role in Phototropism:

If the sun shines on the right side of a plant's shoot, auxins will accumulate on the dark opposite left side. Auxins accumulating there makes the cells on the left side grow much faster than the cells on the right side. When the left side of the shoot starts growing faster than the right side, the shoot will start to bend to the right side towards sunlight. This is phototropism.

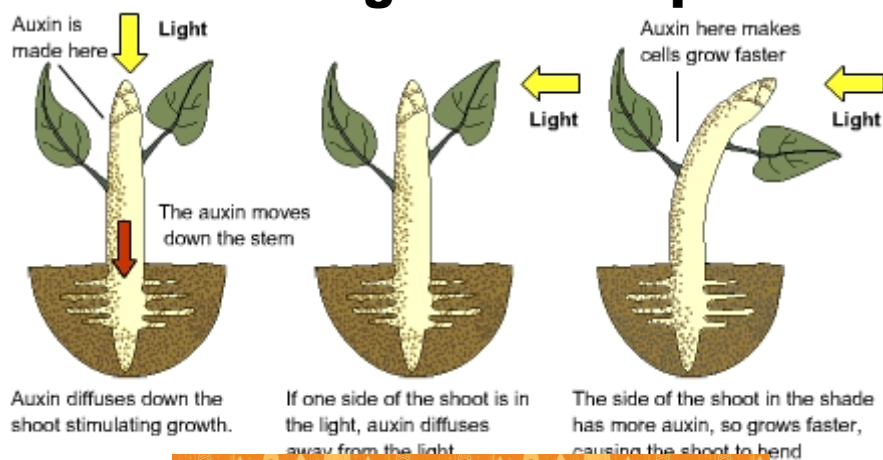

Auxins' Role in Geotropism:

Auxins tend to settle at the bottom end of the root. However, this does not make the cells of the tip of the root grow longer. Instead, auxins prevent the cells at the bottom tip of the root from growing, making the cells at the top of the root grow faster. When the cells of the top of the root grow faster, they push the root deeper into the soil and the root gets longer. The root grows in the direction of the gravitational pull. This is geotropism.

Roots show positive geotropism and negative phototropism because they grow towards gravity and away from sunlight at the same time. Shoots show positive phototropism and negative geotropism because they grow towards the sunlight and away from gravity at the same time.

Advantages of Positive Phototropism:

- **Leaves exposed to more sunlight and are able to do more photosynthesis**
- **Flowers can be seen by insects for pollination**
- **The plant gets higher for better seed dispersal.**

Advantages of Positive Geotropism:

- **By growing deeply into the soil, the root fixes the plant into the ground firmly**
- **Roots are able to reach more water**
- **Roots have a larger surface area for more diffusion and osmosis.**

Selective Weed Killers:

Auxins can be used to kill weeds that grow over grass or cereal crops. If weed grows on crops, auxins are sprayed everywhere. Weeds absorb auxins faster than crops or grass. Auxins accumulate in the weeds making them grow very rapidly. Fast growth of weed kills it leaving the crops or grass alive. Auxins are used as selective weed killers.



Chapter 15: Reproduction:

Reproduction is a characteristic of all living organisms. It is the process that makes more of the same kind of organism. Reproduction is essential in all species to ensure that the species does not extinct. There are two types of reproduction, **Asexual and **sexual** reproduction.**

Asexual Reproduction:

Asexual means not sexual. This means that this kind of reproduction does not involve sex. Asexual reproduction is the production of genetically identical offspring from one parent. It is simply a single organism growing a new organism from itself.

Asexual Reproduction in Bacteria:

Bacteria are tiny single-celled organisms. They reproduce by a process called binary fission. In binary fission, one bacterium grows and exact copy of it's DNA coil which carries its genetic information. Then the bacterium completely divides witch one DNA coil in the parent and one in the daughter bacterium. Each bacterium can undergo binary fission once every 20

minutes making them able to reproduce massive numbers from one parent in very little time.

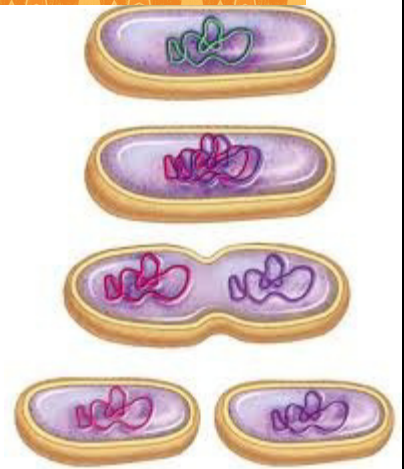

Asexual Reproduction in Fungi:

Earlier, you've studied that fungi are multi-cellular organisms that grow long threads called hyphae on pieces of food. There are two types of hyphae, reproductive and feeding hyphae. Reproductive hyphae grow vertically above the food material. At the top of the hyphae, there is a spherical bag in which many spores are grown. This bag is called sporangium. Spores being produced in the sporangium are reproductive structures that can grow into another fungus. At some point, the sporangium will burst open dispersing the spores into the air. If a spore falls on an area of favourable conditions (food – water – air) it will germinate and grow into a new identical fungus.

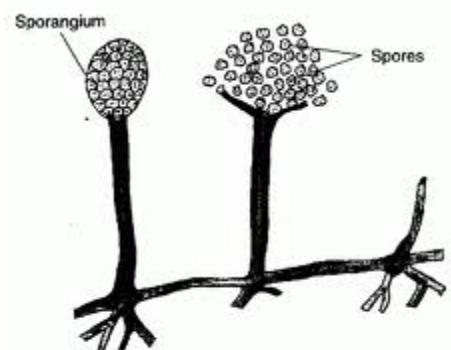
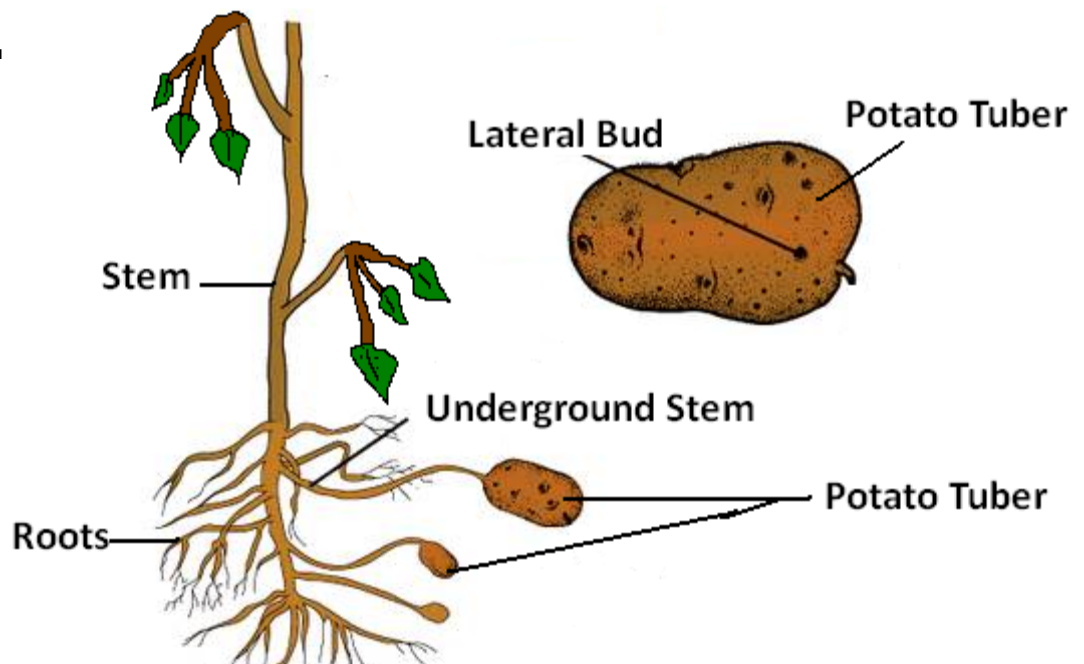

Fig. 4.4: Formation of sporangia and spores in a fungus.

Asexual Reproduction in Potato Plants:

A potato plant starts as a lateral bud (seed) under the soil. In favourable conditions, a shoot grows out from the bud vertically, which then becomes the stem of the plant above the soil. Roots also grow out of the bud downwards into the soil. The bud is now a plant. The stem then grows a part of it under the soil, which is called underground stem. Swellings start to grow from the underground stem, these swellings are called tubers which are the new potatoes. Glucose formed by photosynthesis in the leaves of the above ground stem is converted into sucrose and transported down the stem to the tubers to be stored there as starch. When the tubers are fully grown the mother plant dies and the new lateral buds form on the tubers. These buds then grow into new potato plants identical to the mother plant.



Sexual reproduction is the process involving the fusion of haploid nuclei to form a diploid zygote and the production of genetically dissimilar offspring.

Sexual Reproduction in Flowering Plants:

In a plant, the organs which are responsible for sexual reproduction are the flowers. The diagram below shows a typical flower.

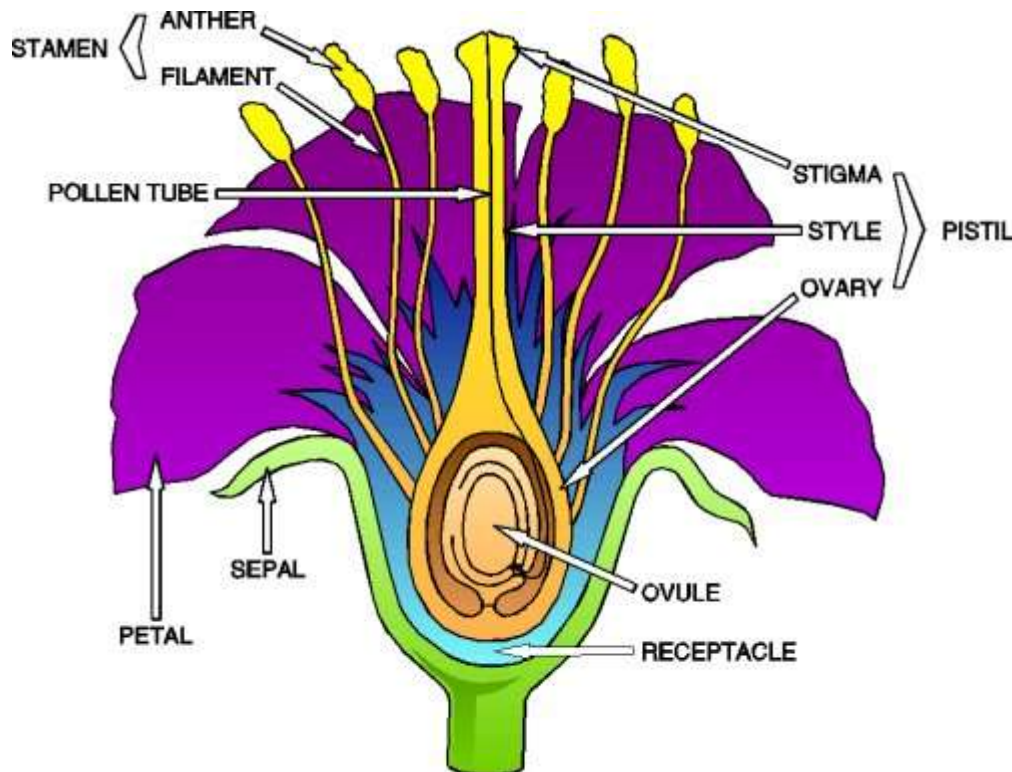

Sex cells are called **gametes. The male gametes are produced inside the anther. And the female gametes are produced inside the ovules. Some flowers can produce both male and female gametes. They are**

called **hermaphrodite**. Male gametes are inside pollen grains in the anthers.

Methods of Pollination:

Pollination is the transfer of pollen grains from the male part of a flower to the female part of a flower.

There are two methods of pollination, **insect pollination and **wind pollination**. Some flowers pollinate by insects while others pollinate by wind.**

Insect pollinating flowers have special attractive features like brightly coloured petals, attractive scents and sugary nectar. These features' aim is to attract insects like bees to come and collect their nectar. While an insect is collecting the nectar, its body will touch the anthers. The pollen grains of insect pollinating flowers have hooks and spikes all over them in order to stick to the bodies of the insect that touch it. When this happens, the pollen grain sticks to the body of the insect. When the insect moves on to another flower to collect its nectar, the pollen grain falls off the insect onto the stigma of the flower, thus insect pollination took place.

Pollen Grain of an insect
pollinating flower



Wind pollinating flowers however look very differently to insect pollinating ones. This is because they do not need attractive features such as bright colours and scents and nectar to attract insects. Instead, their petals are green or brown with their anthers and stigmas hanging outside the flower to be exposed to the wind. When wind is strong enough, it will blow the pollen grains off the anther and carry it along. At some point the wind will get weaker and the pollen grain will land, if it lands on the stigma of a flower of the same species then the pollination was successful. The surface of pollen grains of wind pollinated plants is smooth because it does not need spikes to catch on insects.



Wind pollinated flowers have
their anthers and stigmas hanging
out to be exposed to wind

Self Pollination and Cross Pollination:

Self and cross pollinations are the two types of pollination.

Self pollination: The transfer of a pollen grain from the anther to the stigma of the same flower or the stigma of a flower of the same plant.

Cross Pollination: The transfer of a pollen grain from the anther to the stigma of a flower of another plant of the same species.

Self pollination is considered sexual reproduction because it involves the fusion of two gametes together even though they might come from the same flower or plant.

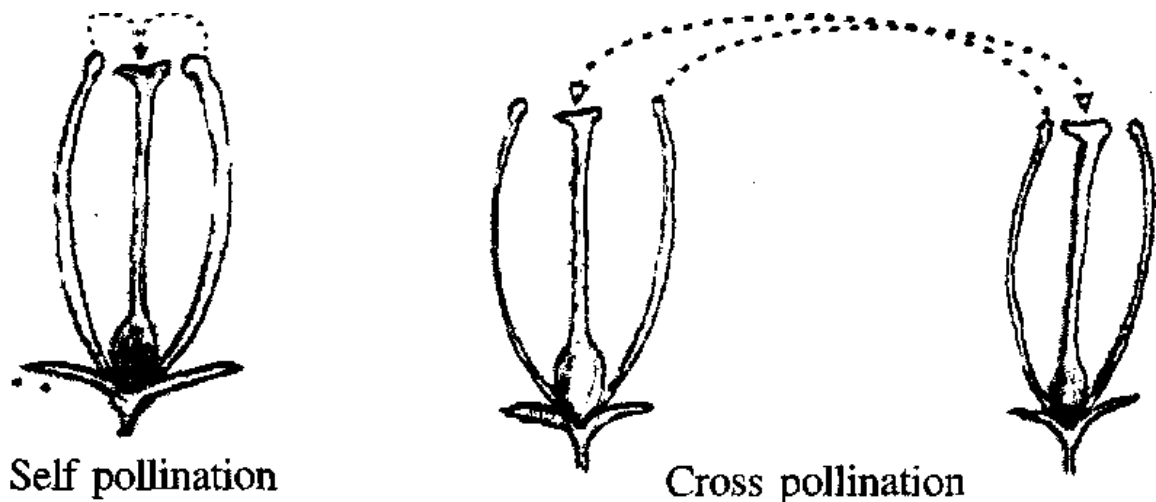
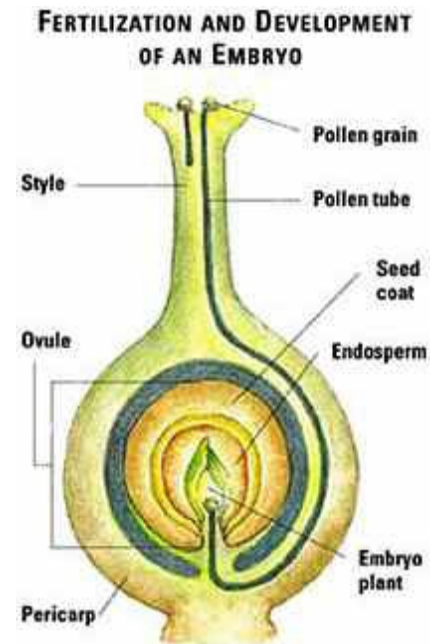

Figure 8.6

Fertilisation:

If a pollen grain lands on the stigma of a flower of the same species, fertilization takes place. This starts by the stigma secreting chemicals that start what's called a **pollen tube**. A pollen tube is the pathway in which the pollen moves downwards to reach the ovule. If a pollen grain falls on the stigma of a flower of a different species, the stigma will not secrete these chemicals and fertilization fails. At the tip of the pollen tube, enzymes are secreted that digest the tissue of the style digging the pollen tube further down till it opens on the other end in the ovule. The male gamete enters the pollen tube and starts its journey downwards to the ovule.



When the male gamete reaches the ovary, it enters the ovule through a hole in its outer shell. The male gamete, which is a haploid nucleus starts fusing with the ovule producing a diploid zygote, then develops into an embryo plant.

Seeds and Fruits:

During the early stages of fertilization, some parts of the fruit become useless, they die and fall off. These parts include the sepals, the petals and the stamens.

The fertilized ovule becomes a seed. Inside the seed is the zygote which develops into an embryo plant. An embryo plant has shoot called **plumule and a root called **radicle**. The plant makes food for the seed and brings it to the seed where it is stored in a structure called **cotyledon** inside the seed. The outside layer of the ovule becomes thicker and harder and is now called the **testa**. In the seed there is a whole called the **micropyle**, this is the whole through which the male gamete entered the ovule. When the seed is fully grown, it becomes dormant. That means it loses its water and metabolic reactions inside it stop. These reactions are reactivated when the seed is planted in favourable conditions including water and air, this is when the seed grows into a new plant. This enables the seed to survive hostile conditions until it is put in somewhere where it can grow into a plant.**

The ovary of a flower contains many ovules. The ones that are fertilized turn into seeds and the ovary its self turns into a fruit in which the seeds are. The function of the fruit is to protect the seeds and to disperse them from the parent plant to colonise new area.

Seed Dispersal:

Seed dispersal is the scattering of the seeds all over the place to colonise he area. It always the plants to grow in new places and contribute to variation of species. A plant can use any of two methods of seed dispersal. These methods are wind dispersal and animal dispersal.

Wind dispersal depends on the fruit having wind or parachute like structure that allows it to float in air to be carried by wind to distant areas in order to spread the species.



The photo on the left is of a dandelion plant. Its fruit grows feathery threads that make it fly over long distances before landing on the soil.

The photo on the left is of a sycamore plant. Its fruit grows two wing like structures that make it spin and fly to distant areas before landing in the soil thus spreading the species.

Other plants rely on animal dispersal. In this method the fruit has hooks all over it which catch in the fur of animals. The animals move from place to place taking the fruit with it until at some point it falls somewhere away from the parent tree. An example of this type of plants is the burdock plant.



A seed remains dormant until it is put in suitable conditions to start growing. These are:

- **Water**
- **Air (oxygen)**
- **Suitable temperature**
- **Some need Sunlight**

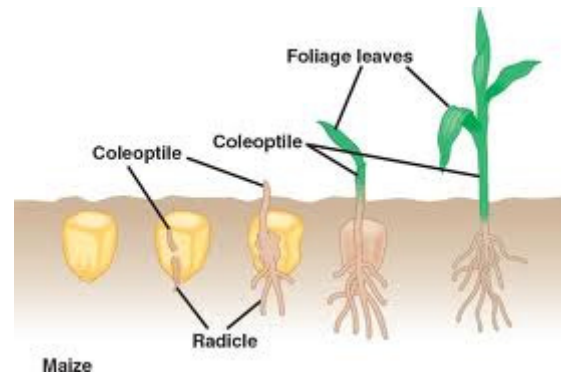

If the seed is put in an area of these conditions it will start germinating. Germinating includes the following steps:

- 1. The water activates enzymes stored in the seed**
- 2. Enzymes start to digest the starch stored in the seed into sugars**
- 3. The sugars produced taken to the embryo and is used as an energy source for growth**
- 4. The radicle (root) grows first, fixing the seedling into the soil where it can absorb more water.**
- 5. The seed is now called a seedling**
- 6. Then the shoot grows vertically.**
- 7. Once the shoot grows the first green leaf the seedling becomes fully independent. (before that it was depending on its storage materials)**
- 8. The plant is now able to photosynthesis and make its own food**

www.studyguide.pk
Sexual Reproduction in Humans:

In humans, the female sex cell (gamete) is called an **egg** or **ova** (Plural: **Ovum**). The male sex cell in humans is called a **sperm**. Sexual reproduction in humans starts by a sexual intercourse followed by the fusion of the two gametes together forming a zygote (Fertilisation).



Sperm



Egg

The Female Reproductive System:

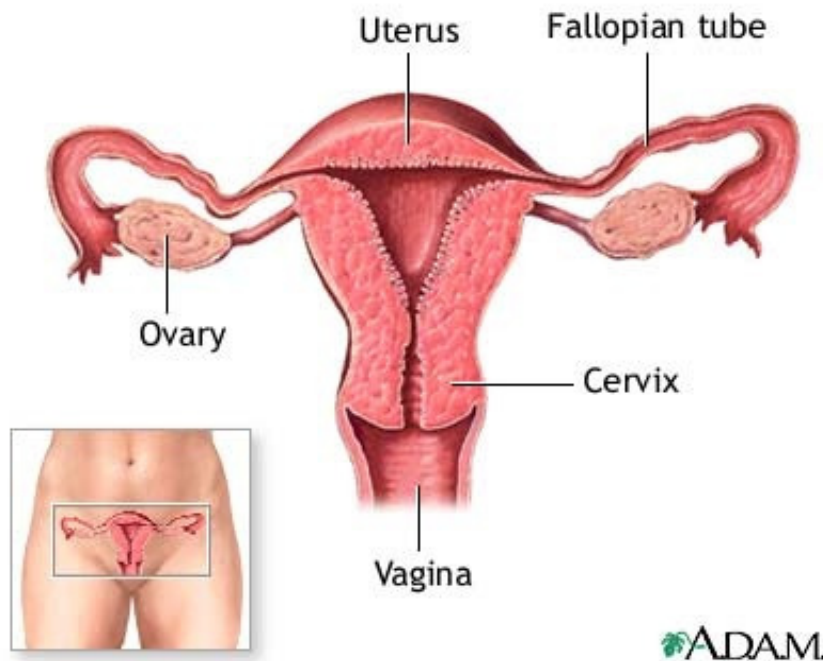

The female reproductive system is located under the stomach. It consists of the following parts:

- **The Ovaries:** There are two ovaries. One on each side. They contain follicles where eggs are produced.
- **Oviducts (Fallopian Tube):** They are two tubes, one on each side connected to an ovary. They are where fertilization occurs and they provide a pathway for the eggs to travel to the uterus by sweeping them by cilia on its walls.
- **Uterus (Womb) :** Where the fetus develops
- **Cervix:** A muscular tissue which separates the vagina from the uterus.
- **Vagina:** it receives the male penis during sexual intercourse

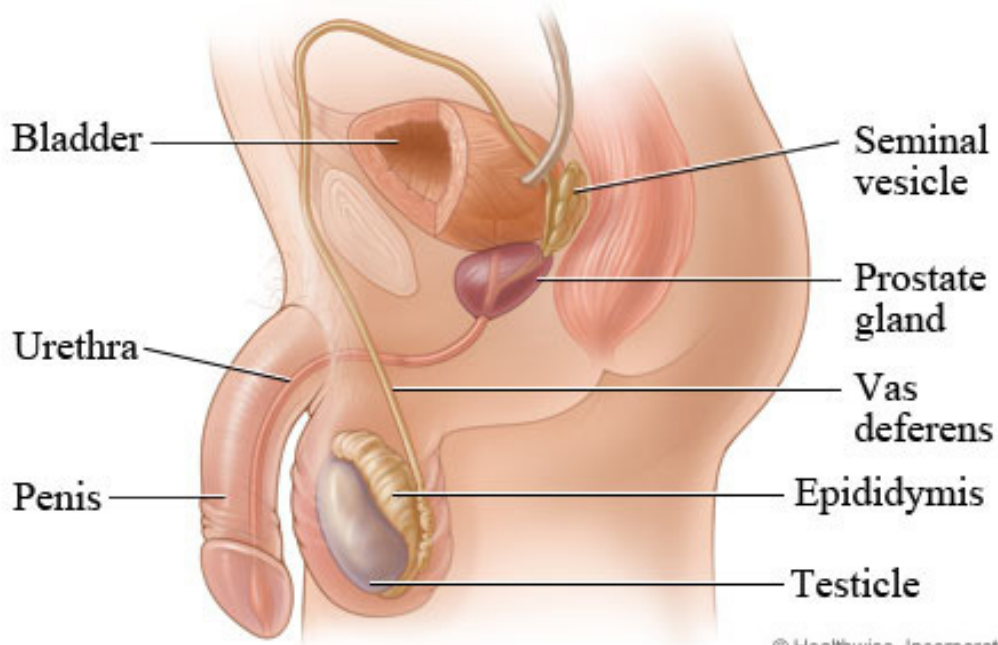

© Healthwise, Incorporated

The male reproductive system is also located under the stomach. It consists of the following parts:

- **Testes:** a male human has two testicles. A testes is a male gland which produces sperms and the male sex hormone testosterone:
- **Scrotum:** it is the sac which contains the testicles
- **Sperm Ducts (Vas deferens):** They are two muscular tubes, each connected to a testis. They carry the sperms from the testis to the urethra
- **Prostate Gland:** It secretes a nutritive fluid to the sperms to form a mixture called semen.
- **Urethra:** It is a tube inside the penis which is the pathway of semen and urine out of the body.
- **Penis:** It is the male sex organ which ejaculates semen into the vagina during sexual intercourse.

- www.studyguide.pk
- **Epididymes:** coiled tubes in which sperms are stored.
 - **Seminal vesicle:** it is another gland like the prostate gland. It also secretes nutritive fluids for sperms to feed from and swim in forming semen.

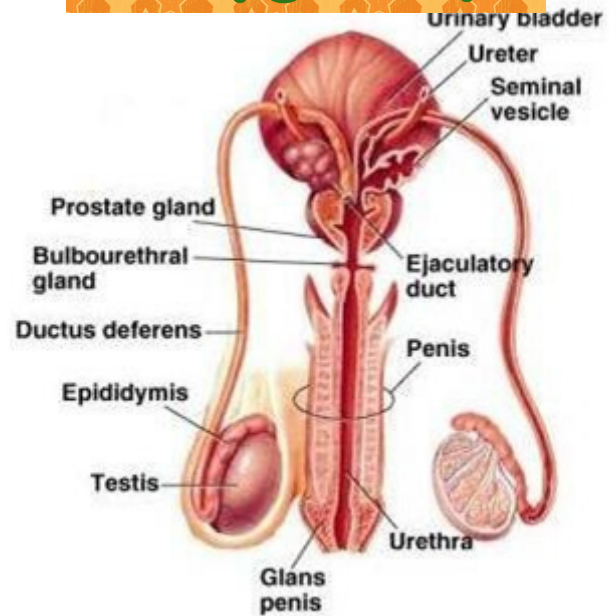

The testicles are inside the scrotum which hangs outside the body. This is because testicles work best at a temperature below that of the body.

Comparing Male and Female Gametes:

Eggs are much bigger than sperms. This is because it needs space to store nutrients on which the embryo feeds on before it reaches the uterus. Eggs being very large makes it wasteful to make plenty of them, this is why a woman has one egg at a time. Sperms however are much smaller and in larger quantities to increase the chance of successful fertilization. Sperms feed on nutrients in the semen fluid. Eggs are unable to move by themselves, they are swept to the uterus by cilia in the walls of the oviduct. On the other hand, sperms have long tails which helps them swim their way to

the egg. A sperm also has a large number of mitochondria to release lots of energy to be used in swimming.

The Sexual Intercourse:

The penis of a male is full of erect tissue and blood vessels. During sexual intercourse the blood pressure increases in the penis making it stiff and erect first to be inserted into the woman's vagina.

Stimulation at the end of the penis causes the muscle tissues along the sperm duct to contract in a wavy-like motion squeezing the sperms from the epididymis to into the sperm duct. The sperms are squeezed past the prostate gland and seminal vesicle which secrete the nutritive fluid to the sperms forming semen.

Sperms + Nutritive Fluid = Semen

The muscles keep contracting against the sperm duct squeezing the semen out of the body through the urethra in the penis. The ejection of semen out of the body is called **ejaculation**. During one ejaculation, about 500 million sperms are secreted.

The semen is ejaculated in the vagina just below the cervix. The sperms are now ready to begin their long, dangerous journey to the egg. The sperms use sugars in the nutritive fluid to release energy which is used to swim through the cervix and in the film of water lining the uterus until they reach the egg. They swim using their tails.

In the woman, an egg lives for several days in one of the oviducts. When the egg dies it is released in the uterus. Fertilization will be successful only if the egg is still living in one of the oviducts. The egg produces chemicals which attract the sperms to it. Many sperms may arrive to the egg but only one can fertilise it.

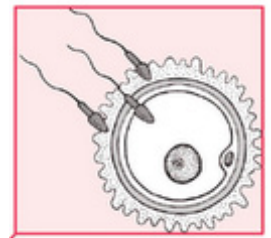

Fertilization

The sperms gather around the egg and compete for it by secreting enzymes which can digest the wall of the egg. Once one of them succeeds in penetrating the wall of the egg, it gets in leaving its tail out. At the same moment this happens, the egg produces an impermeable wall around it called **fertilization membrane** which prevents any more sperms entering the egg. No the nucleus of the sperm can fuse with the nucleus of egg, this is **fertilization**.

Implantation and Development:

After the nuclei of the sperm and the egg fuse together, they become a single cell called the **zygote**. Next, the zygote keeps dividing and producing more cells until a tiny ball of cells is formed. This ball is no bigger than the original egg and is called the **embryo**.

Fertilisation occurs in the oviduct. The development into an embryo takes place while it is moving slowly down the oviduct to the uterus, where the embryo starts developing further. When the embryo reaches the uterus it sinks into the soft lining of the uterus and becomes attached to it. This is called **implantation**.

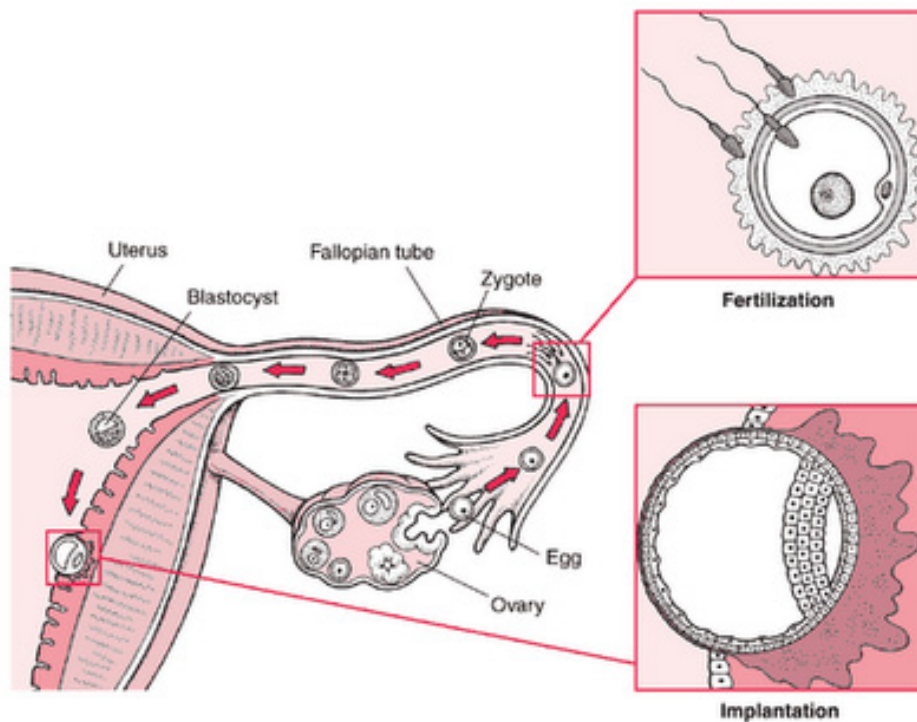

After implantation, the embryo starts further development. Some of the cells of the embryo grow into projections or villi which are fixed firmly into the wall of the uterus. the uterus of the mother also grows set of projections or villi, the two sets of projections grow closely together to form a structure called the **placenta which will be used in substance transfer between the baby and the mother.**

The embryo also starts forming a bag around the baby, this bag is called the **amnion. The majority of the cells of the embryo start dividing rapidly producing a **fetus**, which is the baby.**

Sperm/Egg → Zygote → Embryo → Fetus

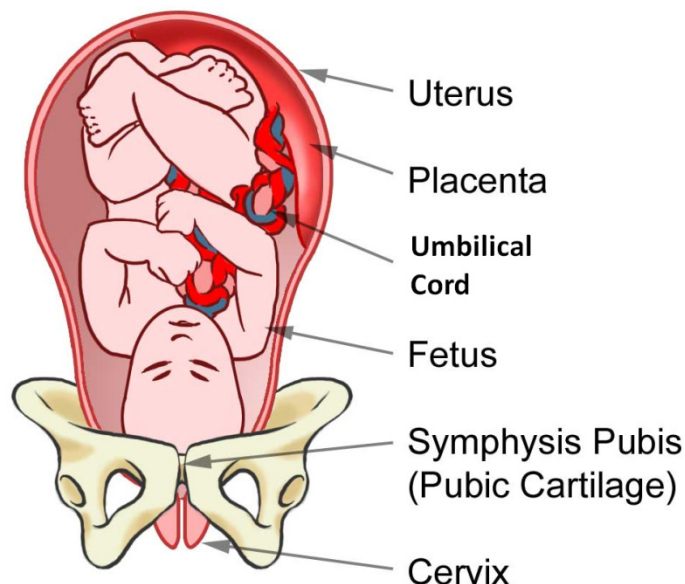

The placenta has two sets of villi, the fetus's set which contains the fetus's blood capillaries, and the mother's set which contains the mother's blood capillaries. The blood flows from the fetus to the fetus's blood vessels in the placenta through **umbilical arteries and veins**.

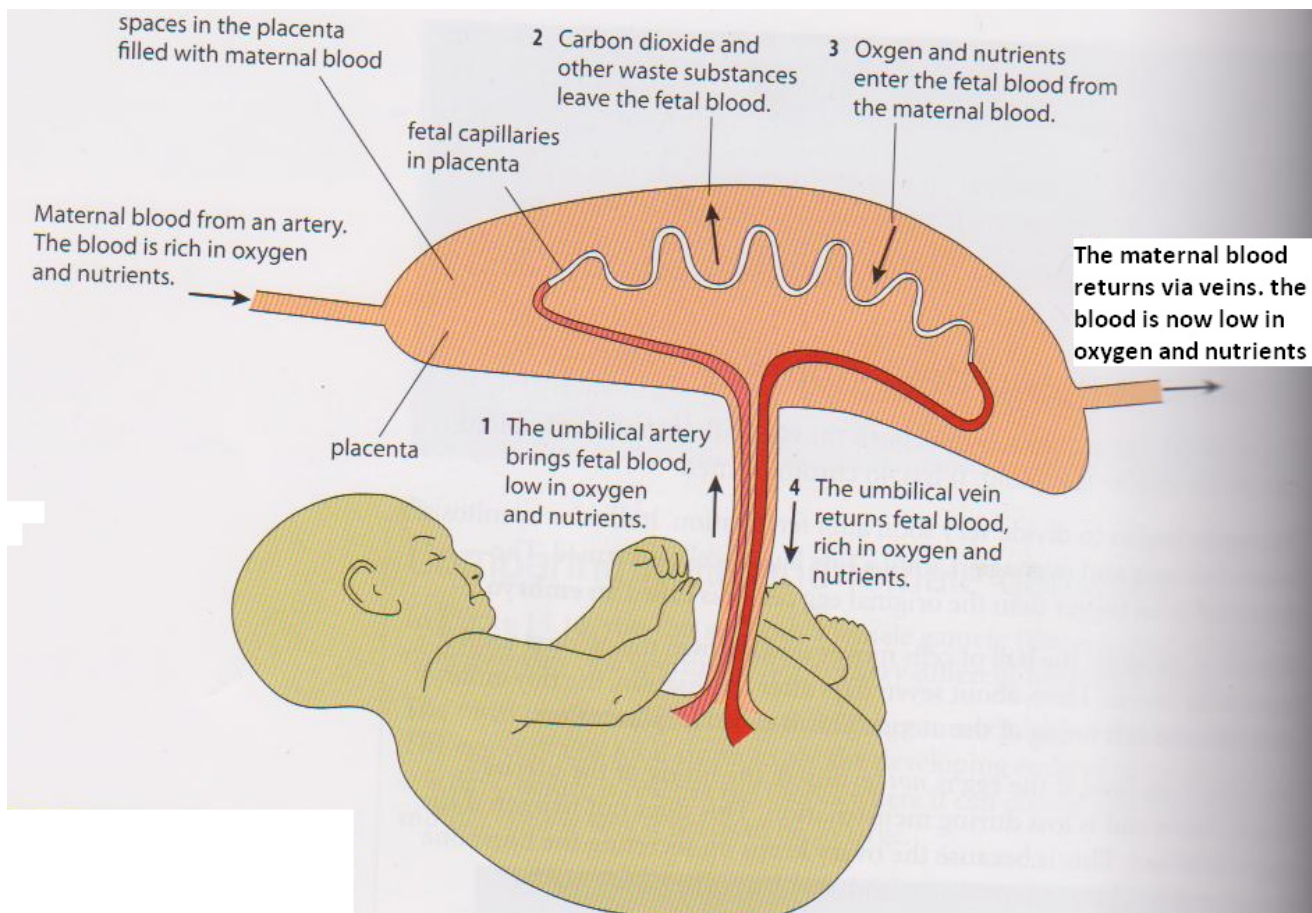

The function of the placenta and the umbilical cord is to exchange substances between the mother and fetus without mixing their bloods together. This is because they might have different blood groups or the mom might have a disease that could be passed to the fetus.

The blood circulation of the fetus includes the placenta. When the blood reaches the blood capillaries of the fetus in the placenta, waste substances like carbon dioxide and urea diffuse from it to the maternal (mother's) blood. The mother then gets rid of these waste materials. Useful substances also diffuse from the maternal blood to the fetus's blood. These include oxygen, amino acids, glucose, vitamins, water, minerals, fatty acids & glycerol. These nutrients are used in building the body of the fetus. Some useful substances also diffuse from the maternal blood to the fetal (fetus's) blood like antibodies and antibiotics.

The placenta has another very important function. That is making oestrogen and progesterone hormones which are essential to keep the uterus in good condition and stimulate milk-producing tissues in the mother.

The fetus which is inside the amnion is surrounded by a fluid called **amniotic fluid**. This fluid protects the fetus from mechanical shock so that it doesn't get harmed if something hits the mother's stomach. The fetus needs no space to breath because it doesn't,

gets its oxygen from the mother and gets rid of the carbon dioxide through her too.

The Mother's Diet:

A pregnant woman's diet is different to that of a normal woman. This is because a pregnant woman needs extra supplies of most nutrients because she is feeding both her self and her baby.

Proteins should be increased in a pregnant woman's body. The growing fetus needs plenty of protein to build new cells. Carbohydrates should also increase since the fetus consumes them too and because it is harder to move when the woman is pregnant. Calcium is one of the most essential minerals for the fetus's growth. This is because it is used in making the bones. If the mother does not increase her intake of calcium the fetus will start absorbing it from her bones and teeth. Iron is needed in large quantities as well. This is to produce more haemoglobin for the mother and the fetus. Drugs should be avoided. The effects a drug has on the mother are also had on the fetus but on a larger, more fatal scale. Drugs can cause unhealthy babies or even early birth giving of an abnormal baby.

Giving Birth:

Nine months after fertilization, the fetus becomes ready to be given birth. Birth starts by the muscles of uterus starting to contract. This causes some pain for the mother. When it is time for the baby to go out, the frequency of the muscle contractions of the uterus increase and they contract more this causes the amnion to break letting the amniotic fluid out. The mother could help in this stage by shouting out loud since it makes the muscles of her body contract. The muscles of the uterus keep contracting pushing the baby out. First out is the head of the baby followed by the rest of the body slipping out. The umbilical cord which still links the baby with the mother is now ready to be cut and tied safely.

Feeding the Young Baby:

The best food for a new born is breast milk. This is because breast milk contains all essential nutrients for the baby like proteins, fats, sugars, vitamins and minerals in easily digestible form. The mother's milk also contains antibodies which are needed by the baby since their immune system has not developed yet. Moreover, breast feeding builds a close bond between the mother and her baby.

If the mother cannot breast feed for any reason, there is another alternative which is formula milk powder. Formula milk powder is mixed with boiled water and fed to the babies in bottles. Formula milk however contains nutrients in harder digestible form which is a disadvantage. Formula milk also lacks of antibodies which are needed by the baby which makes a bottle feeding baby in a greater risk of infection than a breast feeding baby.

Increasing Fertility:

Some couples are unable to have babies. This could be due to lack of egg production in the woman. If this is the case, the problem could be solved by prescribing the woman hormones called fertility drugs which contain a hormone called FSH. Those drugs make her ovulate to make her produce healthy eggs which can be fertilized.

In other cases, the problem could be caused by a problem with the woman's ovaries or the man's sperm's activity. The solution in these cases is called **Vitro fertilization**. In vitro fertilization, the woman is first given fertility drugs to make her produce a lot of eggs. These eggs are then taken out of the woman and

replaced in a sterile dish. Then, the man's sperms are added to the dish. After fertilization happens, one of the fertilized eggs is taken from the dish and put back in the woman's uterus. If this is correctly done, the zygote will develop and the woman will get pregnant.

If there is no hope in the man's sperm, a sperm donor is needed. This is another man who donates his sperm to fertilise the woman's eggs. This can be done naturally by sexual intercourse or by vitro fertilization. This method is called artificial insemination.

Methods of increasing fertility cause a fuss around the world. Some people say that the world's population is big enough and that couples who are unable to have children should deal with it. Others however, think it's every couple's right to have kids. Some people also claim that increasing fertility costs great expenses and that money could be used wisely in other needs.

In a normal woman, one egg is released from the ovaries per month. This is accompanied by other changes. For example, the inner lining of the uterus becomes ready to receive a fertilized egg. The lining of the uterus becomes full of blood capillaries and soft. If fertilization doesn't take place at that time, the egg dies, this is also accompanied by other changes. The thick lining of the uterus becomes unneeded and it breaks down and gets out of the body through the vagina with the dead egg over a period of 4-7 days. This is called **menstruation**. These events are part of what's called the **menstrual cycle** which takes place monthly in a 12-50 years old woman's body. The following diagram represents events of the menstrual cycle.

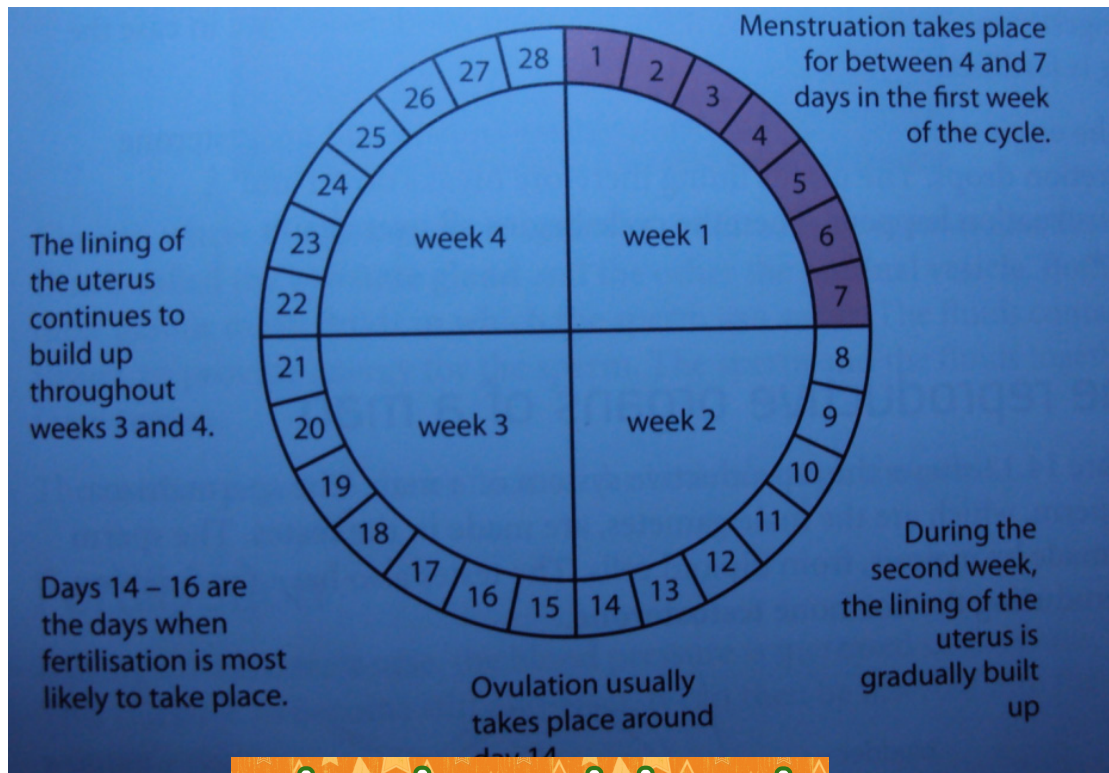

The menstruation cycle is controlled by 4 hormones.

Two of these are made by the ovaries and they are called oestrogen and progesterone. The other two are made by the pituitary gland and they are called the FSH and LH hormones.

During menstruation at the beginning of the cycle, the pituitary gland secretes FSH and LH hormones. These hormones stimulate the ovaries to secrete oestrogen hormone, the function of this hormone is to rebuild the lining of the uterus again once menstruation is finished.

Next, the pituitary gland increases the amount of FSH and LH hormones secreted, specially the LH. The large amounts of LH hormone cause the ovary to release an egg, this is ovulation. This is when fertilization is most likely to be successful if sexual intercourse took place.

Then the amounts of LH, FSH and oestrogen hormones secreted drop. The place where the egg was in the ovary gets occupied by yellow cells which produce and release progesterone hormone. Progesterone

maintains the good condition of the lining of the uterus to ensure implantation if fertilization took place.

If the egg is not fertilized, the yellow cells in the ovary disappear and the progesterone is no longer produced. This causes damage to the lining of the uterus which soon breaks down. Thus menstruation takes place and the cycle starts all over again.

Birth Control:

Birth control is controlling the number of children and the time to have them. A couple may use birth control if they are not ready to have a baby yet. There are several types and methods of birth control. Types of birth control are natural, chemical, mechanical and surgical.

There are two methods of natural birth control. These are **abstinence** and **rhythm method**. Abstinence method is simple avoiding sexual intercourse, this way there is no chance the woman will get pregnant.

Rhythm method is based on the woman understanding her menstrual cycle (period). The woman must be able to sense and predict the time of ovulation when the

egg is in the oviduct waiting to be fertilized, and not have sexual intercourse at that time. The woman can know when it is ovulation time of the cycle by sensing its signs which are change in the natural secretions in her vagina and a slight rise in body temperature. For some women however, it is very difficult to tell when it is ovulation time to avoid having sexual intercourse at it. This can be due to irregular periods or unclear signs of ovulation. This is why the rhythm method is not very reliable.

The chemical type depends on the couple taking chemicals that prevent fertilization or even ovulation. The most chemical method of birth control is the **contraceptive pill**. This is a pill which contains chemicals that prevent the ovaries releasing an egg to the oviduct (ovulation), there won't be an egg ready for fertilization. In some cases, the pill has to be taken every single day, if it is forgotten once there is a chance of pregnancy. The pill is very effective, but it is not preferred by some women since it could bring other side effects such as mood swings, weight gain or circulatory diseases like strokes. The pill has to be prescribed by a doctor who performs a check up on the woman in advance.

The alternative chemical method of birth control is the **spermicidal cream**. This is a cream that contains a substance that will kill sperms. The cream has to be placed in the woman's vagina before sexual intercourse so that it kills the sperms that will be ejaculated. The cream is not entirely effective on its own since some sperms may survive, but it could be used along with other birth control methods.

Mechanical methods of birth control are three. They are the **condom**, the **femidom**, the **diaphragm**, and **IUD**. The condom is the most used method of birth control. It is simply a layer of cover worn on the penis to keep semen from entering the woman's body. It is made of stretchy, impermeable material that won't allow any substance entering the woman's body from the man or vice versa. The condom also has a great advantage, it also prevents diseases or bacteria and viruses passing from the man to the woman or vice versa. The condom is one of the most reliable methods of birth control.

Femidom is a female condom that is worn by the woman instead of the man. It acts like a bag in the vagina in which the penis is inserted and the semen is ejaculated without entering the woman's body.

The third mechanical method of birth control is the diaphragm. The diaphragm is a small, circular piece of rubber which is fit over the woman's cervix to prevent sperms from passing through it. It is impermeable and it can be used along with spermicidal cream to ensure that sperms will not pass through the cervix.

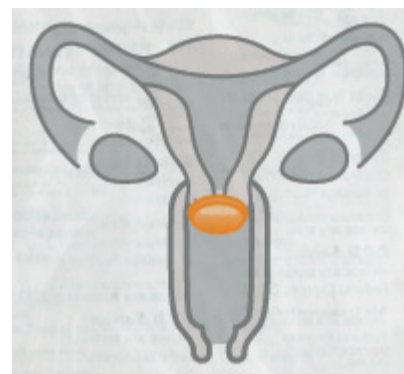

The last mechanical method for birth control is the intra-uterine device or IUD for short. This is a coil of copper or plastic that is fit in the woman's uterus to block the passage of sperms. It is not recommended though because it has some unpleasant side effects like making the periods heavier.

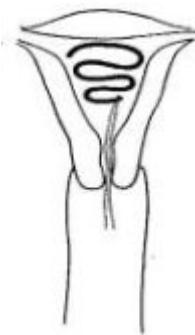

As for surgical methods, one of the couple can perform a surgery to prevent their gametes reaching the site of fertilization. For example the woman could have an operation to cut and seal her oviducts to ensure that the egg can't pass down to the uterus. Or the man could have his sperm ducts cut and sealed, in this way the sperms won't even leave his body. This surgery is called vasectomy and the man is considered sterile

after it. These methods are irreversible and the person who does it can never have kids again.

Sexually Transmitted Diseases:

Sexually transmitted diseases or STD's for short are caused by viruses or bacterium passing from one partner or another during sexual intercourse. The most spread STD's are gonorrhoea and HIV (also known as AIDS).

Gonorrhoea is caused by a bacterium that lives and breeds in damp conditions at 37°C. It lives in the reproductive system of the carrier person. The bacteria could be easily transferred to the partner during sexual intercourse. Symptoms of gonorrhoea in men are very clear. They include sores on the penis, discharges and painful urination. In women however, the symptoms are less noticeable because women's reproductive organs are inside her body. They include discharges which the woman won't be able to differentiate between and the normal vaginal discharges. If a pregnant woman catches the disease, it is likely that the baby will catch it too during giving birth. The disease is easily cured by a course of antibiotics and could be prevented by means of birth

control and not having sexual intercourse with more than one person.

AIDS is a disease caused by the HIV (human immunodeficiency virus). The virus lives in most of body fluids such as blood and reproductive tract. It could be easily transmitted to the other partner during sexual intercourse because their reproductive tracts come in contact. The virus lives and breeds in lymphocytes (white blood cells). The virus could live for years in the body before it starts showing symptoms of the disease. AIDS is short for Acquired Immune Deficiency Syndrome. The disease prevents white blood cells from killing bacteria and viruses, so one or more weak viral or bacterial infections are enough to kill the patient. There is no cure for AIDS till now, it is best to prevent it from spreading by not having sexual intercourse with an infected person. AIDS could also be spread by blood, so it is best prevent your blood mixing the blood of an infected person or share unsterilized, needles that have been used by an infected person to inject drugs into your self.
