

## Introduction to electrolysis

Electrolysis is the process of electrically inducing chemical changes in a conducting melt or solution eg splitting an ionic compound into the metal and non-metal.

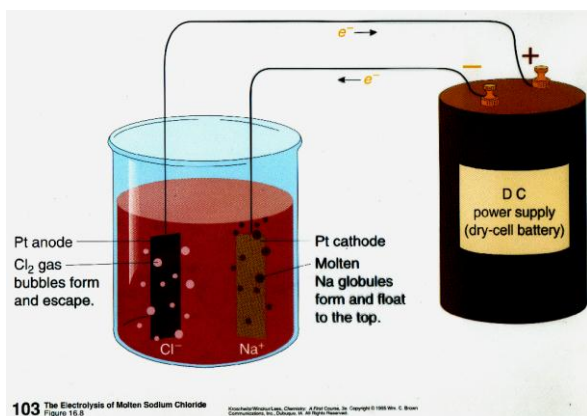

- **SUMMARY OF COMMON ELECTRICAL CONDUCTORS** and **what makes up the circuit?**
  - These materials carry an electric current via freely moving electrically charged particles, when a potential difference (voltage!) is applied across them, and they include:
    - All metals (molten or solid) and the non-metal carbon (graphite).
  - This conduction involves the movement of free or delocalised electrons ( $e^-$  charged particles) and does not involve any chemical change.

Any molten or dissolved material in which the liquid contains free moving ions is called the **electrolyte**. Compounds that dissociate to a large extent (70 to 99%) into ions when dissolved in water are classified as strong electrolytes. Compounds that dissociate to a small extent are termed weak electrolytes.

- **Ions** are charged particles eg  $\text{Na}^+$  sodium ion, or  $\text{Cl}^-$  chloride ion, and their movement or flow constitutes an electric current, because a **current is moving charged particles**.
- **What does the complete electrical circuit consist of?**
- There are two ion currents in the electrolyte flowing in opposite directions
  - positive cations eg  $\text{Na}^+$  attracted to the negative cathode electrode,
  - and negative anions eg  $\text{Cl}^-$  attracted to the positive anode electrode,
  - remember no electrons, they flow in metal wires or carbon (graphite)!
- The circuit of 'charge flow' is completed by the electrons moving around the external circuit eg copper wire, metal or graphite electrode, from the positive to the negative electrode
- The molten or dissolved materials are usually **acids, alkalis or salts** and their electrical conduction is usually **accompanied by chemical changes** eg decomposition.

- The chemical changes occur at the **electrodes** which connect the electrolyte liquid containing ions with the external **d.c. electrical supply**.

If the current is switched off, the electrolysis process stops.

**Liquids that conduct must contain freely moving ions to carry the current and complete the circuit.**

- You can't do electrolysis with an ionic solid!, the ions are too tightly held by chemical bonds and can't flow from their ordered situation!
- When an ionic substance is melted or dissolved in water the ions are free to move about.
  - However some covalent substances dissolve in water and form ions.
  - eg hydrogen chloride HCl, dissolves in water to form 'ionic' hydrochloric acid  $\text{H}^+\text{Cl}^-_{(\text{aq})}$
- The solution or melt of ions is called the **electrolyte** which forms part of the circuit. The circuit is completed by eg the external copper wiring and the (usually) inert electrodes like graphite (form of carbon) or platinum AND electrolysis can only happen when the current is switched on and the circuit complete.
- ELECTROLYSIS SPLITS a COMPOUND:**
  - When substances which are made of ions are dissolved in water, or melted material, they can be broken down (decomposed) into simpler substances by passing an electric current through them.
  - This process is called electrolysis.
  - Since it requires an 'input' of energy, it is an endothermic process.
- During electrolysis in the electrolyte (solution or melt of free moving ions) ...
  - positive metal or hydrogen ions move to the negative electrode (cations attracted to cathode), eg in the diagram, sodium ions  $\text{Na}^+$ , move to the -ve electrode,

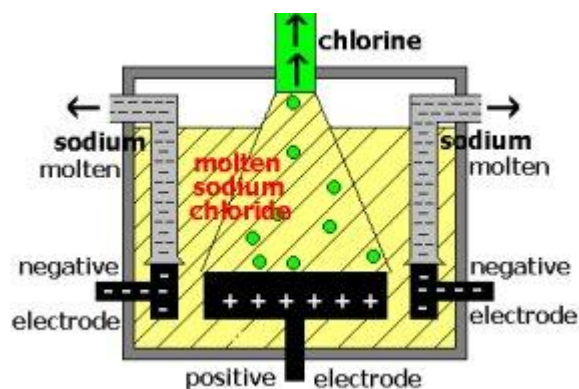

- and negatively charged ions move to the positive electrode (anions attracted to anode), eg in the diagram, chloride ions  $\text{Cl}^-$ , move to the +ve electrode.
- During electrolysis, gases may be given off, or metals dissolve or are deposited at the electrodes.
  - Metals and hydrogen are formed at the negative electrode from

positive ions by electron gain (reduction), eg in molten sodium chloride

- sodium ions change to silvery grey liquid sodium,  $\text{Na}^+ + \text{e}^- \Rightarrow \text{Na}$

- and non-metals eg oxygen, chlorine, bromine etc. are formed from negative ions changing on the positive electrode by electron loss (oxidation), eg in molten sodium chloride
  - chloride ions change to green chlorine gas,  $2\text{Cl}^- - 2\text{e}^- \Rightarrow \text{Cl}_2$ .
- In a chemical reaction, if an oxidation occurs, a reduction must also occur too (and vice versa) so these reactions 'overall' are called **redox changes**.
  - You need to be able to complete and balance electrode equations or recognise them and derive an overall equation for the electrolysis.

## ELECTROLYSIS OF MOLTEN COMPOUNDS

### Electrolysis of Molten Lead (II) bromide.

Electrolyte: Molten lead (II) bromide.  $\text{PbBr}_2$

Electrode: carbon ( inert )

Ions present:  $\text{Pb}^{2+} + 2\text{Br}^{1-}$

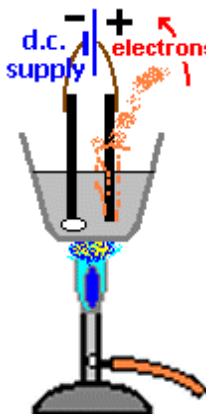

*Reaction at cathode ( negative electrode)*

Lead ions + 2 electrons -----> Lead atoms.

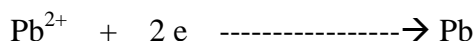

Molten lead will collect at the bottom near cathode.

*Reaction at anode (negative electrode)*

Bromide ions -----> bromine gas + 2 electrons

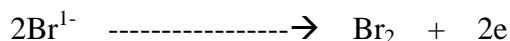

Bromine gas will be discharged at anode as a reddish brown gas.

*The over all reaction:*

Lead Bromide-----> Molten lead + Bromine gas

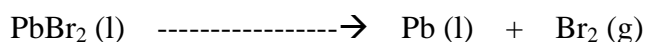

## Electrolysis of Molten Bauxite

Electrolyte: Molten Aluminum oxide ( $\text{Al}_2\text{O}_3$ )  
 Electrodes: Carbon  
 Ions present:  $\text{Al}^{3+}$  &  $\text{O}^{2-}$

### The Extraction of Aluminium

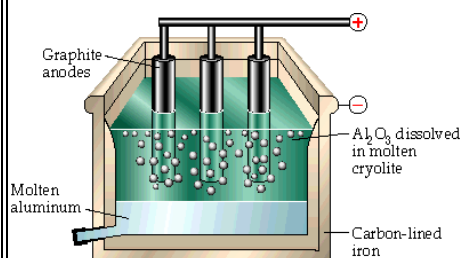
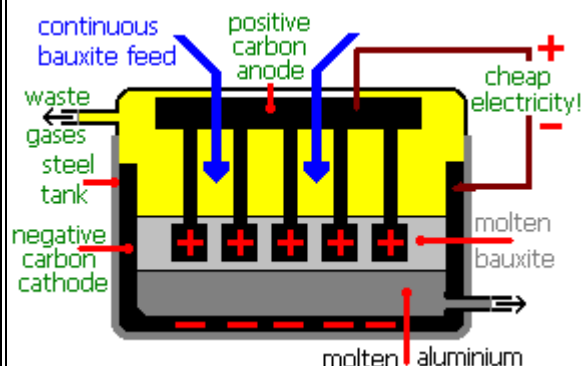

- The purified **bauxite ore** of **aluminium oxide** is continuously fed in. **Cryolite** is added to lower the melting point and dissolve the ore.
- Ions must be free to move to the electrode connections** called the **cathode (-)**, attracting positive ions eg  $\text{Al}^{3+}$ , and the **anode (+)** attracting negative ions eg  $\text{O}^{2-}$ .
- When the d.c. current is passed through **aluminium forms at the positive cathode (metal\*)** and sinks to the bottom of the tank.
- At the negative **anode, oxygen gas is formed (non-metal)**. This is quite a problem. At the high temperature of the electrolysis cell it burns and oxidises away the carbon electrodes to form toxic carbon monoxide or carbon dioxide. So the **electrode is regularly replaced** and the waste gases dealt with!
- It is a costly process (6x more than Fe!) due to the **large quantities of expensive electrical energy** needed for the process.

#### Raw materials for the electrolysis process:

- Bauxite ore of impure aluminium oxide [ $\text{Al}_2\text{O}_3$  made up of  $\text{Al}^{3+}$  and  $\text{O}^{2-}$  ions]
- Carbon** (graphite) for the electrodes.
- Cryolite** reduces the melting point of the ore and saves energy, because the **ions must be free to move** to carry the current
- Electrolysis** means **using d.c. electrical energy to bring about chemical changes eg decomposition of a compound** to form metal deposits or release gases. The electrical energy splits the compound!
- At the **electrolyte** connections called the **anode electrode (+)**, attracts - ions) and the **cathode electrode (-)**, attracts + ions). An **electrolyte** is a **conducting melt or solution of**

#### The redox details of the electrode processes:

- At the **negative (-) cathode, reduction** occurs (**electron gain**) when the **positive aluminium ions** are attracted to it. They gain three electrons to change to neutral Al atoms.

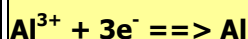

- At the **positive (+) anode, oxidation** takes place (**electron loss**) when the **negative oxide ions** are attracted to it. They lose two electrons forming neutral oxygen molecules.

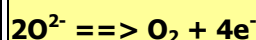

- Note: Reduction and Oxidation** always go together!
- The **overall electrolytic decomposition** is

**freely moving ions** which carry the charge of the electric current.

...

- **aluminium oxide => aluminium + oxygen**
- **$2\text{Al}_2\text{O}_3 \implies 4\text{Al} + 3\text{O}_2$**
- and is a very **endothermic process**, lots of electrical energy input!

*Reaction at cathode ( negative electrode)*

Aluminum ions + 3 electrons -----> Molten Aluminum

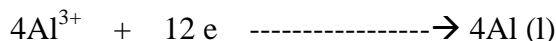

Molten aluminum will collect at the bottom near cathode.

*Reaction at anode (negative electrode)*

Oxide ions -----> oxygen gas + 12 electrons

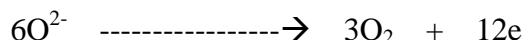

Oxygen gas will be discharged at anode.

*The over all reaction:*

Aluminum oxide -----> Molten Aluminum + oxygen gas

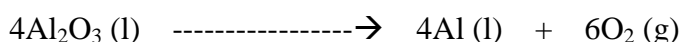

## ELECTROLYSIS OF SOLUTIONS

### Electrolysis of Brine

Electrolyte: Aqueous Sodium chloride NaCl

Electrodes: Carbon / Copper

Ions present:  $\text{H}^+$ ,  $\text{OH}^-$ ,  $\text{Na}^+$ ,  $\text{Cl}^-$ .

**Sodium chloride solution** gives equal volumes of hydrogen gas (-) and green chlorine gas (+) with sodium hydroxide left in solution. However in dilute solution, oxygen gas as well as chlorine gas is produced.

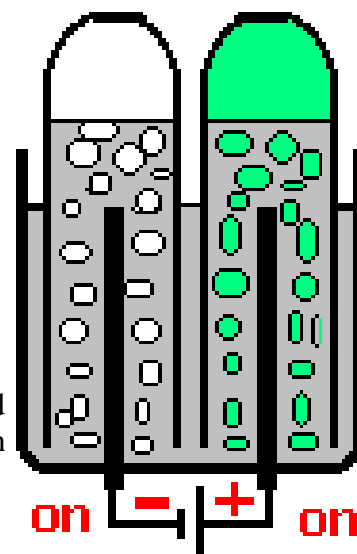

*Reaction at cathode ( negative electrode)*

Hydrogen ions + 2e -----> Hydrogen gas.

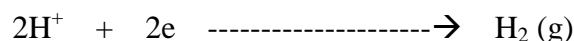

Hydrogen gas liberated at cathode.

*Reaction at anode ( positive electrode)*

Chloride ion -----> Chlorine gas + 2 electrons

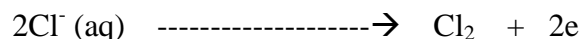

Chlorine gas liberated at anode.

*Over all reaction*

Sodium chloride + Water --> Hydrogen gas + Chlorine gas + Sodium hydroxide

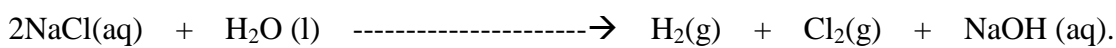

## Electrolysis of Concentrated HCl

Electrolyte: Aqueous Hydrochloric acid HCl

Electrodes: Carbon / Copper

Ions present:  $\text{H}^+$ ,  $\text{OH}^-$ ,  $\text{Cl}^-$ .

*Reaction at cathode ( negative electrode)*

Hydrogen ions + 2e -----> Hydrogen gas.

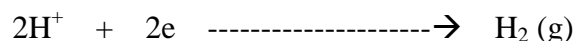

Hydrogen gas liberated at cathode.

*Reaction at anode ( positive electrode)*

Chloride ion -----> Chlorine gas + 2 electrons.

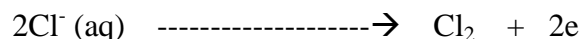

Chlorine gas liberated at anode.

*Over all reaction*

Hydrochloric acid -----> Hydrogen gas + Chlorine gas

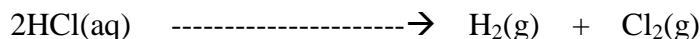

### Electrolysis of dilute sulphuric acid

Electrolyte: Aqueous Sulphuric acid  $\text{H}_2\text{SO}_4$

Electrodes: Carbon / Copper

Ions present:  $\text{H}^+$ ,  $\text{OH}^-$ ,  $\text{SO}_4^{2-}$ .

*Reaction at cathode ( negative electrode)*

Hydrogen ions +  $2e^-$  -----> Hydrogen gas.

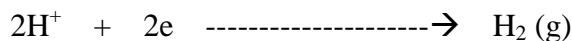

Hydrogen gas liberated at cathode.

*Reaction at anode ( positive electrode)*

Hydroxide ions-----> Oxygen gas + water + 4 electrons

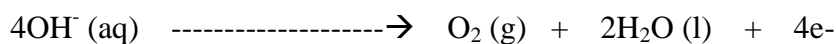

Oxygen gas liberated at anode

*Over all reaction*

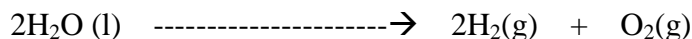

### Electrolysis of copper (II) sulphate solution using copper electrodes.

Electrolyte: Aqueous Copper sulphate solution ( $\text{CuSO}_4$ )

Electrodes: Copper metal

Ions present:  $\text{H}^+$ ,  $\text{OH}^-$ ,  $\text{Cu}^{2+}$ ,  $\text{SO}_4^{2-}$ . Copper

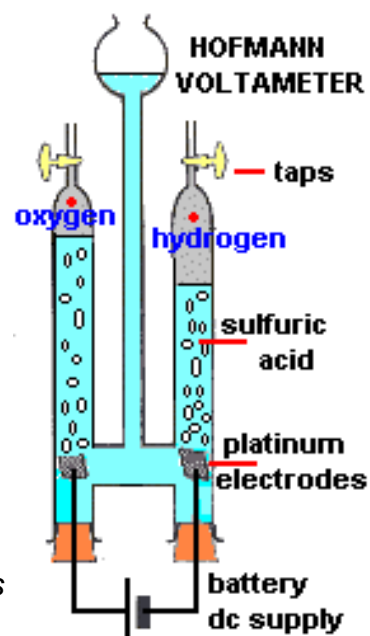

**Copper(II) sulphate** with copper electrodes, the copper deposits at cathode and the copper dissolves from anode. The blue colour of the  $\text{Cu}^{2+}$  ions stays constant because  $\text{Cu}$  deposited =  $\text{Cu}$  dissolved. Both involve a 2 electron transfer so it means mass of  $\text{Cu}$  deposited = mass of  $\text{Cu}$  dissolving.

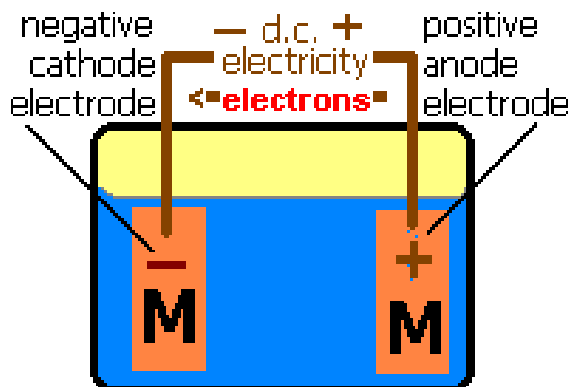

*Reaction at cathode ( negative electrode)*

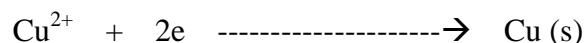
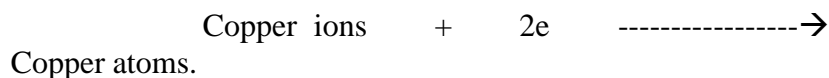

Copper metal deposit at cathode.

*Reaction at anode ( positive electrode)*

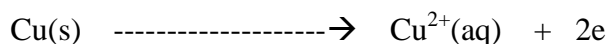
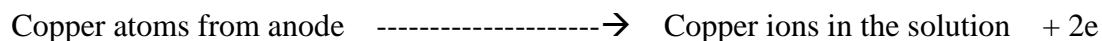

Copper metal of anode will dissolve and added in electrolyte.

This method is used to refine copper.

### Electrolysis of copper (II) sulphate solution using graphite electrodes.

Electrolyte: Aqueous Copper sulphate solution  $\text{CuSO}_4$

Electrodes: Graphite

Ions present:  $\text{H}^+$ ,  $\text{OH}^-$ ,  $\text{Cu}^{2+}$ ,  $\text{SO}_4^{2-}$ .

*Reaction at cathode ( negative electrode)*

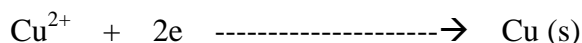
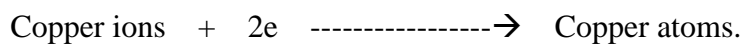

Copper atom deposit on cathode.

*Reaction at anode ( positive electrode)*

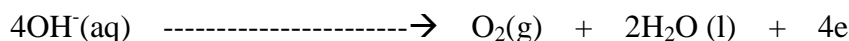

Oxygen gas is liberated at anode.



## ELECTROLYSIS OF SOLUTIONS USING INERT ELECTRODES

<i>ELECTROLYTE</i>	<i>IONS IN SOLUTIONS</i>		<i>PRODUCT AT (-) CATHODE</i>	<i>PRODUCT AT (+) ANODE</i>
<b>Concentrated HCl</b>	H <sup>+</sup> (aq)	Cl <sup>-</sup> (aq)	Hydrogen gas	Chlorine gas
<b>Concentrated NaCl solution</b>	Na <sup>+</sup> (aq)	Cl <sup>-</sup> (aq)	Hydrogen gas from water	Chlorine gas
<b>Dilute Sulphuric Acid</b>	H <sup>+</sup> (aq)	SO <sub>4</sub> <sup>2-</sup> (aq)	Hydrogen gas	Oxygen gas from water
<b>Copper (II) Sulphate Solution</b>	Cu <sup>2+</sup> (aq)	SO <sub>4</sub> <sup>2-</sup> (aq)	Copper metal	Oxygen gas from water

## ELECTRODE PRODUCTS FROM DIFFERENT IONS IN AQUEOUS SOLUTION (USING INERT ELECTRODE)

<b>CATION</b>	<b>PRODUCT AT CATHODE</b>	<b>ANION</b>	<b>PRODUCT AT ANODE</b>
K <sup>+</sup> Na <sup>+</sup> Ca <sup>2+</sup> Mg <sup>2+</sup> Al <sup>3+</sup>	Hydrogen gas from water	Cl <sup>-</sup> Br <sup>-</sup> I <sup>-</sup>	Chlorine Bromine Iodine
Ni <sup>2+</sup> Pb <sup>2+</sup> H <sup>+</sup> Cu <sup>2+</sup> Ag <sup>+</sup>	Nickel Lead Hydrogen Copper Silver	SO <sub>4</sub> <sup>2-</sup> NO <sub>3</sub> <sup>-</sup>	Oxygen from water Oxygen from water

## ELECTROPLATING

The coating of a metal object with another metal object is called Electroplating. It is carried out in a cell called plating bath. It contains an electrolyte. For silver plating electrolyte is a solution of silver salt. The article to be plated is made the cathode in the cell so that metal ions move to it when current is switched on.

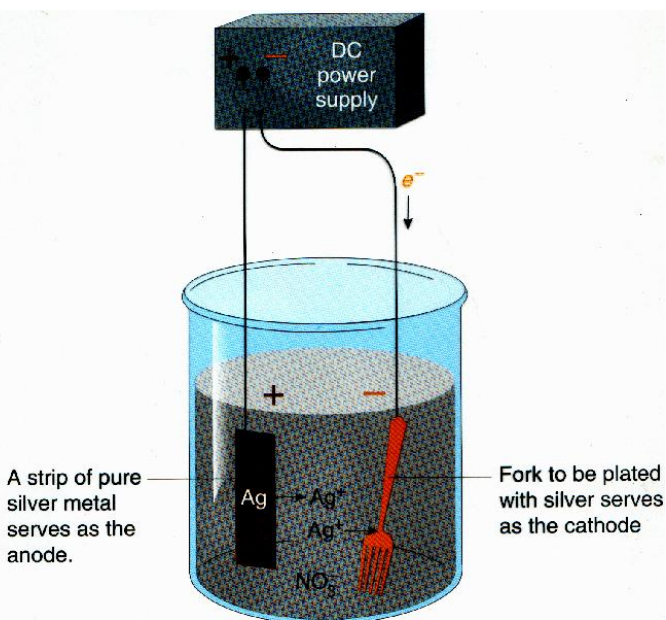

104 Electroplating  
Figure 16.3

© 1995 Wm. C. Brown Communications, Inc. Dubuque, IA. All Rights Reserved.

- **GENERAL NOTE ON ELECTROLYSIS:**
- **What does the complete electrical circuit consist of?**
  - There are two ion currents in the electrolyte flowing in opposite directions:
    - positive cations eg  $Al^{3+}$  attracted to the negative cathode electrode,
    - and negative anions eg  $O^{2-}$  attracted to the positive anode electrode,
    - BUT remember no electrons flow in the electrolyte, only in the graphite or metal wiring!
  - The circuit of 'charge flow' is completed by the electrons moving around the external circuit eg copper wire or graphite electrode, from the positive to the negative electrode
  - This  $e^-$  flow from +ve to -ve electrode perhaps doesn't make sense until you look at the [electrode reactions](#), electrons released at the +ve anode move round the external circuit to produce the electron rich negative cathode electrode.

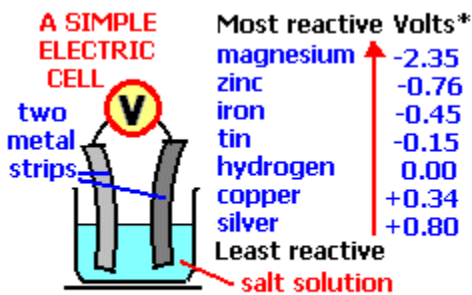

(\* when used as an electrode and compared to hydrogen 0.00 V)

## 4. Simple Cells or batteries

- In electrolysis, electrical energy is taken in (endothermic) to enforce the oxidation and reduction to produce the products.
- The chemistry of simple cells or batteries is in principle the opposite of electrolysis.
- A redox reaction occurs to produce products and energy is given out. It is exothermic, BUT the energy is released as electrical energy and the system shouldn't heat up.
- A simple cell can be made by dipping two different pieces of metal (of different reactivity) into a solution of ions eg a salt or dilute acid.
- The greater the difference in reactivity, the bigger the voltage produced. However this is not a satisfactory 'battery' for producing even a small continuous current.
- One of the first practical batteries is called the 'Daniel cell'.
  - It uses a half-cell of copper dipped in copper(II) sulphate,
  - and in electrical contact with a 2nd half-cell of zinc dipped in zinc sulphate solution.
  - The zinc is the more reactive, and is the negative electrode, releasing electrons because
    - on it zinc atoms lose electrons to form zinc ions,  $\text{Zn}_{(s)} \Rightarrow \text{Zn}^{2+}_{(aq)} + 2e^{-}$
  - The less reactive metal copper, is the positive electrode, and gains electrons from the negative electrode through the external wire connection and here ..
    - the copper(II) ions are reduced to copper atoms,  $\text{Cu}^{2+}_{(aq)} + 2e^{-} \Rightarrow \text{Cu}_{(s)}$
  - Overall the reactions is:  $\text{Zn}_{(s)} + \text{CuSO}_{4(aq)} + \text{ZnSO}_{4(aq)} + \text{Cu}_{(s)}$ 
    - or ionically:  $\text{Zn}_{(s)} + \text{Cu}^{2+}_{(aq)} + \text{Zn}^{2+}_{(aq)} + \text{Cu}_{(s)}$
  - The overall reaction is therefore the same as displacement reaction, and it is a redox reaction involving electron transfer and the movement of the electrons through the external wire to the bulb or voltmeter etc. forms the working electric current.
- The **cell voltage can be predicted** by subtracting the less positive voltage from the more positive voltage:
  - eg a magnesium and copper cell will produce a voltage of  $(+0.34) - (-2.35) = 2.69$  Volts
  - or an iron and tin cell will only produce a voltage of  $(-0.15) - (-0.45) = 0.30$  Volts.
  - Note (i) the bigger the difference in reactivity, the bigger the cell voltage produced and

- (ii) the 'half-cell' voltages quoted in the diagram are measured against the  $\text{H}^+(\text{aq})/\text{H}_2(\text{g})$  system which is given the standard potential of zero volts.
- **Cells or batteries are useful and convenient portable sources of energy** but they are expensive compared to what you pay for 'mains' electricity.

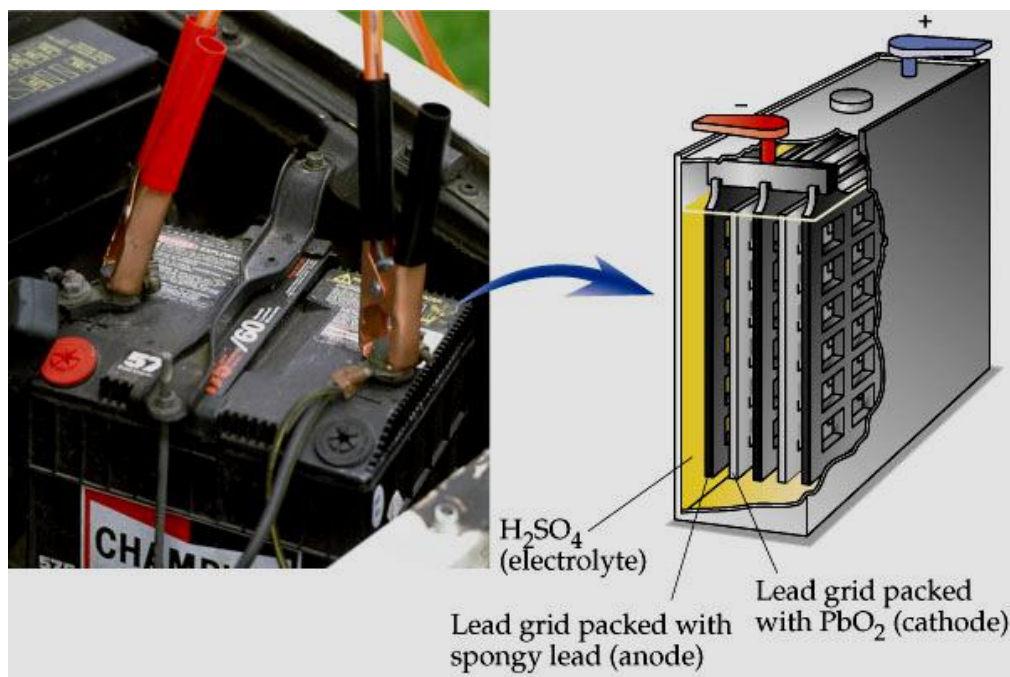

## 5. Fuel Cells



- **Hydrogen gas can be used as fuel.**
  - It burns with a pale blue flame in air reacting with oxygen to be oxidised to form water.
    - **hydrogen + oxygen ==> water** or  $2\text{H}_2(\text{g}) + \text{O}_2(\text{g}) ==> 2\text{H}_2\text{O}(\text{l})$
  - It is a non-polluting clean fuel since the only combustion product is water.
  - It would be ideal if it could be manufactured by electrolysis of water eg using solar cells.
  - Hydrogen can be used to power fuel cells.
  - It all sounds wonderful BUT, still technological problems to solve for large scale manufacture and distribution of 'clean' hydrogen gas or use in generating electricity AND its rather an inflammable explosive gas!
- **Fuel cells are 'battery systems' in which two reactants can be continuously fed in.** The consequent redox chemistry produces a working



current.

- Hydrogen's potential use in fuel and energy applications includes powering vehicles, running turbines or fuel cells to produce electricity, and generating heat and electricity for buildings and **very convenient for remote and compact situations like the space shuttle**.
- When hydrogen is the fuel, the product of its oxidation is water, so this is potentially a clean non-polluting and non-greenhouse gas? fuel.
- Most fuel cells use hydrogen, but alcohols and hydrocarbons can be used.
- A fuel cell works like a battery but does not run down or need recharging as long as the 'fuel' supply is there.
- It will produce electricity and heat as long as fuel (hydrogen) is supplied.

## DIAGRAM and CHEMISTRY

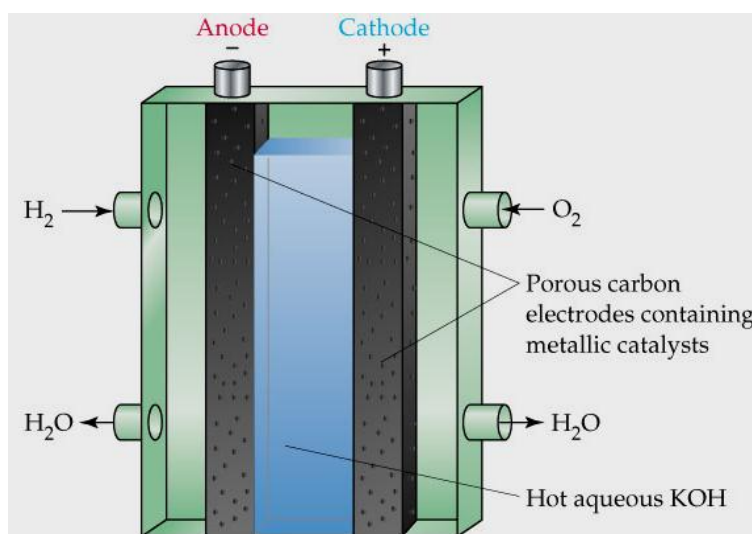

- A fuel cell consists of two electrodes consisting of a negative electrode (or anode) and a positive electrode (or cathode) which are sandwiched around an electrolyte (conducting

salt/acid/alkali solution of free ions).

- Hydrogen is fed to the (+) anode, and oxygen is fed to the (-) cathode.
- The **platinum catalyst** activates the hydrogen atoms/molecules to separate into protons ( $H^+$ ) and electrons ( $e^-$ ), which take different paths to the (+) cathode.
  - The electrons go through an external circuit, creating a flow of electricity eg to light a bulb.
  - The protons migrate through the electrolyte and pass through the semi-permeable membrane to the cathode, where they reunite with oxygen and the electrons to produce water.
- **Each cell only produces a small voltage (0.4V?)** so many cells can be put

together in series to give a bigger working voltage.

• **Note on reverse action:**

- If there is spare electricity from another source available, you can run the fuel cell in reverse and electrolyse the water to make hydrogen and oxygen (acting as an electrolyser).
- The two gases are stored, and when electricity or heat needed, the fuel cell can then be re-run using the stored gaseous fuel.
- this is called a regenerative fuel cell system.
- You can use solar energy from external panels on the space shuttle to do this, and use the fuel when in the 'darkness of night'.

	<p>equation</p> <p>1 oxidation</p> <p>2 reduction</p> <p>3 = 1 + 2</p>	<p>summary of hydrogen-oxygen fuel cell</p> <p><math>2\text{H}_{2(g)} \rightleftharpoons 4\text{H}^+_{(aq)} + 4\text{e}^-</math> (at -ve anode electrode*)</p> <p><math>\text{O}_{2(g)} + 4\text{H}^+_{(aq)} + 4\text{e}^- \rightleftharpoons 2\text{H}_2\text{O}_{(l)}</math> (at +ve cathode electrode*)</p> <p><math>2\text{H}_{2(g)} + \text{O}_{2(g)} \rightleftharpoons 2\text{H}_2\text{O}_{(l)}</math></p>
--	--	--

**DONE**