

IGCSE CHEMISTRY

AN INTERACTIVE REVISION GUIDE

ANDREW RICHARD WARD
BSC PGCE MA(ED) MRSC



ENDORSED BY
THE ROYAL SOCIETY OF CHEMISTRY AND CAMBRIDGE EXAMINATIONS BOARD.

CONTENTS

PRINCIPLES OF CHEMISTRY

1. PARTICULATE NATURE OF MATTER
2. EXPERIMENTAL TECHNIQUES
3. ATOMS, ELEMENTS AND COMPOUNDS
4. STOICHIOMETRY

PHYSICAL CHEMISTRY

5. ELECTRICITY AND CHEMISTRY
6. CHEMICAL CHANGES
7. CHEMICAL REACTIONS
8. ACIDS, BASES AND SALTS

INORGANIC CHEMISTRY

9. THE PERIODIC TABLE
10. METALS
11. AIR AND WATER
12. SULPHUR
13. CARBONATES

ORGANIC CHEMISTRY

14. ORGANIC CHEMISTRY

INTRODUCTION

**THIS STUDY GUIDE IS A REVISION GUIDE
IT IS NOT A TEXTBOOK
IT IS TO BE USED ALONGSIDE A TEXT BOOK AND
CLASSROOM NOTES AS A REFERENCE TEXT TO HELP WITH
EXAM REVISION**

**THE ESSENTIAL FACTS NEEDED FOR CHEMISTRY AT IGCSE
ARE SUMMARIZED WITH A MINIMUM OF FUSS AND
MAXIMUM EFFECT**

**MR. WARD HAS BEEN A SECONDARY TEACHER OF SCIENCE,
MATHEMATICS AND ICT SINCE 1992.**

**MR. WARD IS A GRADUATE OF UNIVERSITIES IN THE
NORTH EAST OF ENGLAND WHERE HE OBTAINED HIS
BACHELORS AND MASTERS DEGREES.**

**MR. WARD IS CURRENTLY STUDYING FOR HIS DOCTORATE
OF EDUCATION AT LONDON UNIVERSITY, ENGLAND WHERE
HE IS SPECIALIZING IN THE USE OF MIND-MAPPING TO
ENHANCE SCIENCE EDUCATION.**

**MR. WARD CAN BE CONTACTED ON 66735119
AND BY EMAIL AT ANDREWRICHARDWARD@YAHOO.CO.UK**

**THIS GUIDE CONTAINS NEARLY 300 PAGES AND IS THE
MOST CONCISE AND ONLY ELECTRONIC GUIDE TO
CHEMISTRY CURRENTLY AVAILABLE IN KUWAIT**

**“MAXIMUM EFFECT – MINIMUM NOTES – MAXIMUM
GRADES”**

**NON SCHOLAE SED VITAE DISCIMUS
“IT IS NOT FOR SCHOOL – BUT FOR LIFE”**

**IN MEMORY OF MARY PATTISON 1918 – 1988.
MY GUIDING LIGHT WHO IS ALWAYS LOVED AND NEVER
FORGOTTEN.**

TOPIC 1 – ALL ABOUT MATTER

Chemistry is the study of matter

Matter is all the substances and materials that the universe is made from.

There are many millions of known chemical substances.

All can be classified as solid, liquid or gas.

SOLID

Definite fixed shape and volume

Increase in size when heated – expand

Decrease in size when cooled – contract

LIQUID

Has a fixed volume

Takes up shape of container it is poured into

Liquids slightly expand when heated also

Can be compressed – volume gets smaller when pressure added

GAS

No fixed shape or volume

Takes up shape of container it is placed into and expands evenly within it

Very noticeable change in volume when the temperature is increased.

Gases are much more easy to compress than liquids

KINETIC THEORY OF MATTER

Explains the way in which matter behaves.

The kinetic theory tells us all matter is made from PARTICLES.

Kinetic theory explains the physical properties of matter in terms of the way that the particles move.

There are 3 main points to the Kinetic Theory:

All matter is made from invisible tiny particles. The particles can be called atoms, molecules or ions and can be different sizes.

The particles move all of the time. High temperature = fast movement

At any temperature, heavier particles move slower than lighter ones.

DESCRIPTION OF PARTICLES IN SOLID, LIQUID AND GAS

SOLID- Particles vibrate around fixed positions. Regular structure

LIQUID- Particles have some freedom to move around each other. Many collisions

GAS- Particles move freely and randomly in available space. Collide less than in liquid – particles as far apart as possible

CHANGES OF STATE

Solid to liquid = melting

Liquid to gas = boiling or evaporation

Gas to liquid = condensation

Liquid to solid = freezing

Sometimes a solid may change directly into a gas – missing out the liquid stage.

This is called SUBLIMATION.

Iodine is a black solid. It sublimes to form a purple gas.

Here is a table to show the melting point and boiling point of some chemical substances

SUBSTANCE	MELTING POINT(CELSIUS)	BOILING POINT (CELSIUS)	EXPLANATION
Aluminium	661	2467	SOLID – IT HAS NOT MELTED YET
Ethanol	-117	79	LIQUID – MELTED AT LOW TEMPERATURE
Magnesium oxide	2827	3627	SOLID – NOT YET MELTED
Mercury	-30	357	LIQUID – ALREADY MELTED
Methane	-182	-164	GAS – ALREADY MELTED AND BOILED
Oxygen	-218	-183	GAS – ALREADY MELTED AND BOILED

HEATING AND COOLING CURVES

Here is the heating curve for water

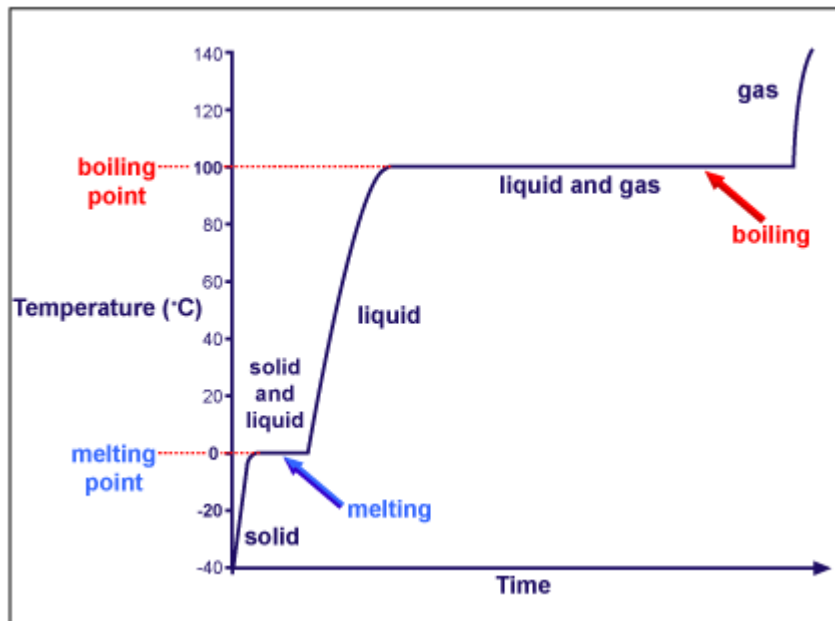

(BY KIND PERMISSION OF THE BBC, UK)

At the start, only ice is present.

After a bit, the curve goes flat.

This means that even as we put heat energy in, the temperature stays the same.

In ice, particles are close together and are attracted to one another.

For ice to melt, the particles must get enough energy to overcome the forces of attraction in the water molecules to allow movement. This is where the heat energy is going.

The temperature rises again after all of the ice has melted.

The heating curve of a pure solid always stops rising at the melting point.

A sharp melting point means a pure sample.

ADDING IMPURITIES LOWERS MELTING POINT

ICE CAN MELT AT -15 CELSIUS BY ADDING SALT TO IT.

If we want to boil the water, we have to give it extra energy.

This can be seen on the graph when the curve levels out at 100 Celsius which is the boiling point of water.

The reverse processes of condensation and freezing occur on COOLING.

Energy is given out when the gas condenses to a liquid and the liquid freezes to a solid.

DIFFUSION

DIFFUSION IS THE MOVEMENT OF PARTICLES FROM A REGION OF HIGH CONCENTRATION TO LOW CONCENTRATION DOWN A DIFFUSION GRADIENT.

The diagram below shows how the diffusion of bromine molecules can be shown. Within 24 hours, the molecules of bromine spread out from a high concentration at the bottom of the gas jar and spread evenly throughout the total volume of the two gas jars.

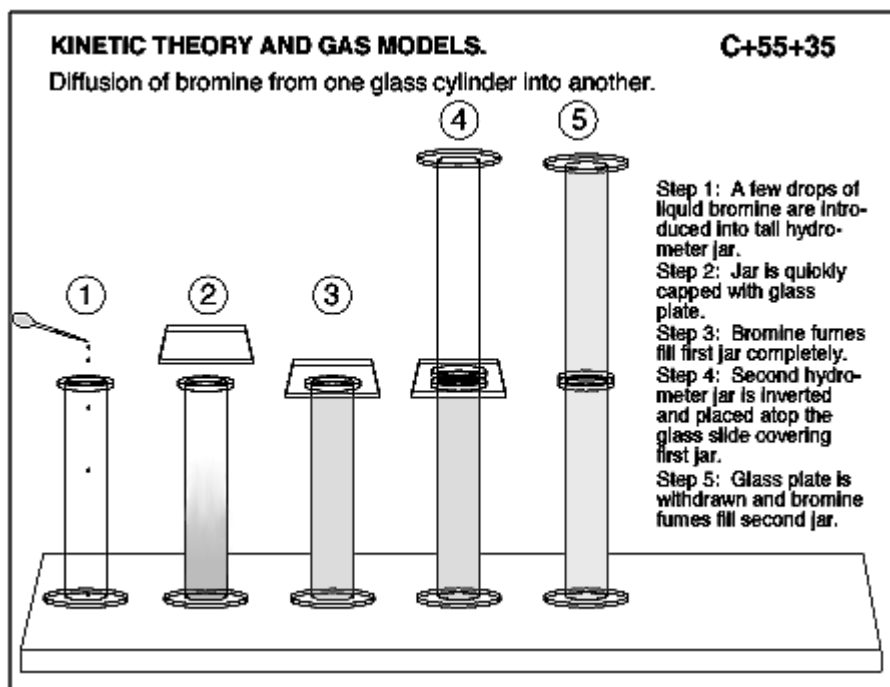

Here is a sequence to show how molecules move down a diffusion gradient. The example chosen is for dissolving sugar in water:

Copyright © The McGraw-Hill Companies, Inc. Permission required for reproduction or display.

Diffusion

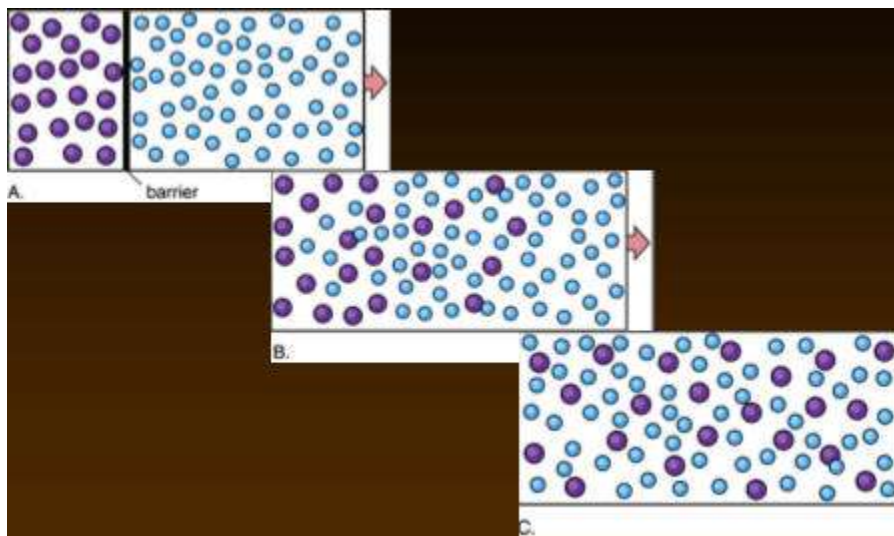
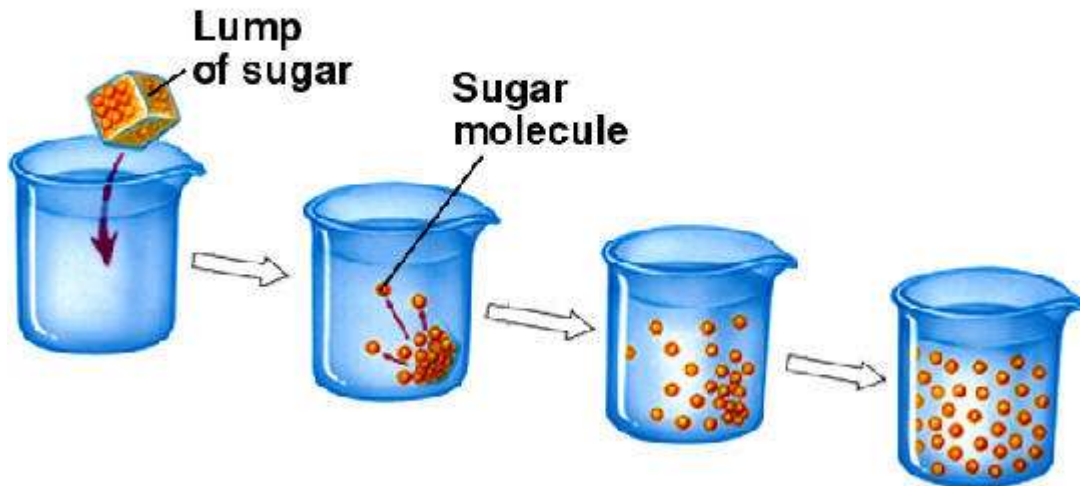

We will now consider Brownian Motion

BROWNIAN MOTION

Robert Brown discovered this in 1827. This theory explains movement of particles in liquids. Brown discovered that pollen grains moved on the surface of water when he looked at them through a microscope. The grains were moving in **RAPID RANDOM MOTION**. This was later called **BROWNIAN MOTION**.

Here is a photograph of the Brownian Motion of particles when photographed under a microscope. You will see that the motion is rapid and random.

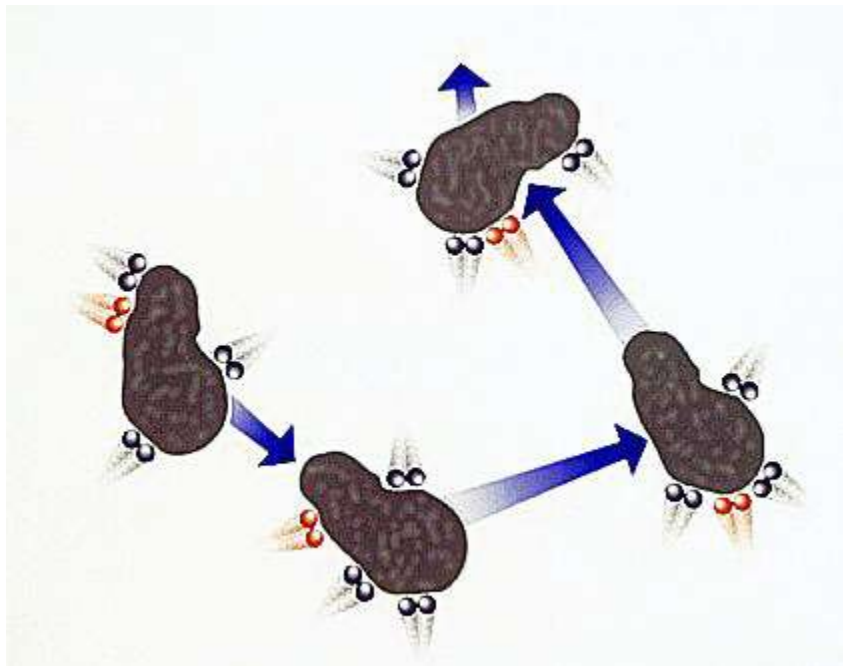

Photograph them with a microscope:



Shows a pattern:

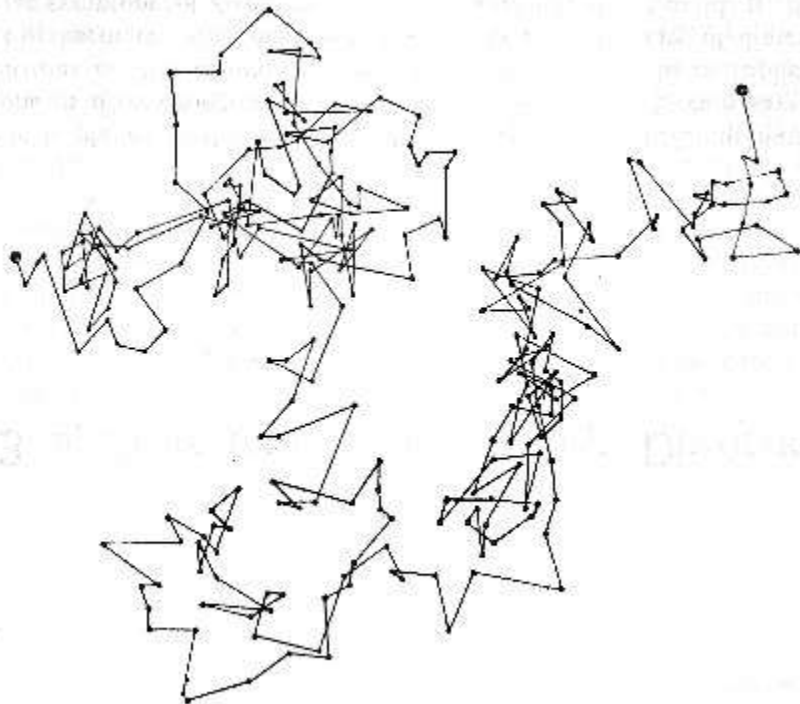

GAS LAWS

This topic is studied in detail in Physics but is shown here for you to understand the behavior of gases in more detail:

There are 2 gas laws which are important. They are named after the scientists who made their discoveries:

BOYLE'S LAW

When we keep temperature the same, the volume of a fixed mass of gas is inversely proportional to the pressure.

This means

Large volume of gas = low pressure of gas

Small volume of gas = high pressure of gas

CHARLES' LAW

When we keep the pressure the same, the volume of a given mass of gas is directly proportional to the temperature.

This means

Large volume of gas = high temperature of gas

Small volume of gas = low temperature of gas

This is the end of chapter one.

A checklist of definitions is shown on the next page.

You must be able to write them down by memory for your examinations.

TOPIC 1 CHECKLIST

ABSOLUTE TEMPERATURE

This is the temperature measured with respect to absolute zero (zero Kelvin) on the Kelvin Scale.

Temperature in Kelvin = Temperature in Celsius + 273

ATMOSPHERIC PRESSURE

This is the pressure of the atmosphere on the surface of the Earth due to the weight of the air.

BOILING POINT

The temperature at which gas pressure above a liquid equals atmospheric pressure

BOYLE'S LAW

At a constant temperature, the volume of a given mass of gas is inversely proportional to the pressure.

$$V=1/p$$

CHARLES' LAW

At constant pressure, the volume of a given mass of gas is directly proportional to absolute temperature.

CONDENSATION

This is the change of vapour of a gas into a liquid. This process involves heat being produced.

DIFFUSION

This is the process by which different substances mix because of the rapid random motion of their particles

EVAPORATION

This is a process that occurs at the surface of a liquid and involves the change of state of a liquid into a vapour at the temperature below boiling point.

KINETIC THEORY

A theory which accounts for the properties of materials in terms of constituent particles

MATTER

Anything that occupies space and has a mass

MELTING POINT

This is the temperature at which a solid starts to turn liquid. Pure substances have a sharp, defined melting point.

SOLIDS, LIQUIDS AND GASES

These are the three states of matter to which all substances belong

SUBLIMATION

The direct change of state from solid to gas or gas to liquid.

TOPIC 2: ELEMENTS, COMPOUNDS AND MIXTURES

The name element was invented by Robert Boyle in 1661.

Elements are made from only one type of atom.

An element cannot be split into a simpler substance by any known chemical process.

Atoms are tiny

20000000000000000 atoms = 1cm

115 elements have been identified.

24 have been artificially made by scientists – like plutonium

91 are naturally occurring and can be found in the ground

All elements can be classified as metals or non-metals

The properties of metals and non-metals are different.

Here is a table to show the differences in the properties of metals and non-metals

PROPERTY	METAL	NON-METAL
Physical state at room temperature	Usually solid (occasionally liquid like mercury)	Solid, liquid or gas
Malleability (can be beaten into sheets?)	Good	No – usually soft and brittle when solid
Ductility (can be stretched into wires)	Good	No – usually soft and brittle when solid
Appearance as a solid	Shiny	Dull
Melting point	Usually high	Usually low
Boiling point	Usually high	Usually low
Density	Usually high	Usually low
Conductivity of heat and electricity	Good	Very poor

ATOMS

Everything in the universe is made from billions of atoms.

Atoms are too small to be seen by the eye.

The smallest atom- hydrogen atoms – are 0.00000007 mm wide.

Chemists use shorthand symbols to label elements and their atoms.

Usually the first or first two letters of the name of the element are used.

Some elements that were discovered many years ago still have Latin names like Sodium – Na – Latin name Natrium

Lead – Pb – Latin name Plumbum

MOLECULES

The atoms of some elements are joined together in small groups called molecules.

Hydrogen, oxygen, nitrogen, fluorine, chlorine, bromine and iodine have atoms that are joined in pairs. They are known as DIATOMIC MOLECULES.

A phosphorus has 4 atoms joined together, a sulphur molecule has 8 atoms joined together.

Gases like helium, neon, argon, bromine, krypton and xenon are composed of separate individual atoms – MONOATOMIC MOLECULES.

COMPOUNDS

Compounds are pure substances formed when two or more elements chemically combine together. Water is an example of a compound.

Water is made from two elements hydrogen and oxygen.

Hydrogen (a pure element) + oxygen (a pure element)
forms water (a pure compound formed from hydrogen gas burning in oxygen gas)

Water contains two atoms of hydrogen and one atom of oxygen to give water a chemical formula .

Elements other than hydrogen will react with oxygen gas to form chemical compounds called OXIDES.

Magnesium reacts violently in oxygen gas to form a new chemical compound called magnesium oxide.



The magnesium oxide (new compound formed) is a white powder.

We know we form a new compound as magnesium is a shiny metal and oxygen is a colourless gas.

When a new substance is formed in a chemical reaction, we say that a **CHEMICAL CHANGE** has taken place.

MAGNESIUM + OXYGEN = MAGNESIUM OXIDE

When substances like hydrogen and magnesium combine with oxygen gas, they are **OXIDISED**. This process is called **OXIDATION**.

REDUCTION is the **COMPLETE OPPOSITE** of oxidation.

In **REDUCTION**, **OXYGEN IS** removed.

For example, iron has to be removed from iron ore in the Blast Furnace. This can be done by the poisonous gas called carbon monoxide.

The iron ore has **OXYGEN REMOVED BY REDUCTION** to form molten iron.

Carbon monoxide has **OXYGEN ADDED BY OXIDATION** to form carbon dioxide.

In this reaction both **REDUCTION** and **Oxidation** have taken place.

This type of reaction is called a **REDOX** reaction.

You will learn about this in detail in chapter 9.

MORE ABOUT FORMULAE

What is a chemical equation?

When a chemical reaction occurs, it can be described by an equation. This shows the chemicals that react (called the *reactants*) on the left-hand side, and the chemicals that they produce (called the *products*) on the right-hand side. The chemicals can be represented by their names or by their chemical symbols.

Unlike mathematical equations, the two sides are separated by an arrow, that indicates that the reactants form the products and not the other way round.

A large number of chemical equations are more complicated than the simple ones you will see in this section. They are *reversible*, which means that the reactants react together to form the products, but as soon as the products are formed, they start to react together to reform the reactants!

Reversible equations proceed in both directions at once, with reactants forming products and products forming reactants simultaneously. Eventually, the system settles down and a balance (an equilibrium) is reached, with the reactants and products present in stable concentrations. This does not mean that the reaction stops, merely that it proceeds in both directions at the same rate, so that the concentrations do not change.

Reversible reactions are indicated with a double arrow as shown in the example below:



In this case, ethanol (which is alcohol, basically) reacts with ethanoic acid (the main constituent of vinegar) to form ethyl ethanoate and water. However, the ethyl ethanoate produced reacts with the water produced to recreate the ethanol and ethanoic acid again. In practice, the chemicals reach a balance point, called *equilibrium* where all four chemicals are present.

The concept of balancing equations

Take a look at this chemical word equation:

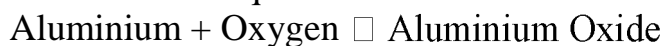

This is the equation for the burning of aluminium in oxygen. If we convert each of the chemical names into the appropriate symbols, we get the following:

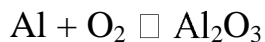

Note that oxygen gas is *diatomic*, which means that the oxygen atoms, like policemen, go around in pairs. A molecule of aluminium oxide consists of two aluminium atoms combined with three oxygen atoms. Actually, technically the word "molecule" is inappropriate in that previous sentence. The formula simply tells us the ratio of aluminium atoms to oxygen atoms in the compound. In the solid state, the atoms form a giant structure called a *crystal lattice* rather than individual discrete molecules. When balancing chemical equations, people often refer to the number of *species* on each side to avoid this problem.

You can see by looking at it that there is something wrong with this equation. If you count the number of atoms of each type on each side, you will see that there is only one aluminium atom on the left side whereas there are two on the right. There are two oxygen atoms on the left side, as compared to three on the right side. This clearly doesn't match.



We can balance the equation by *mutiplying* the different atoms and molecules on each side by different amounts. Firstly, multiply the aluminium atoms on the left side by 2:

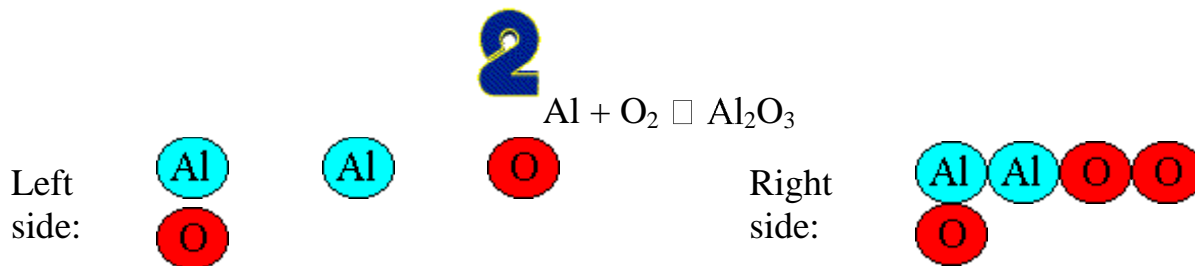

Now there are the same number of aluminium atoms on each side of the equation. We could also multiply the number of oxygen molecules on each side by one and a half (1.5), which would give three oxygen atoms on the left side (1.5 x 2 = 3) to match the three oxygen atoms on the right side:

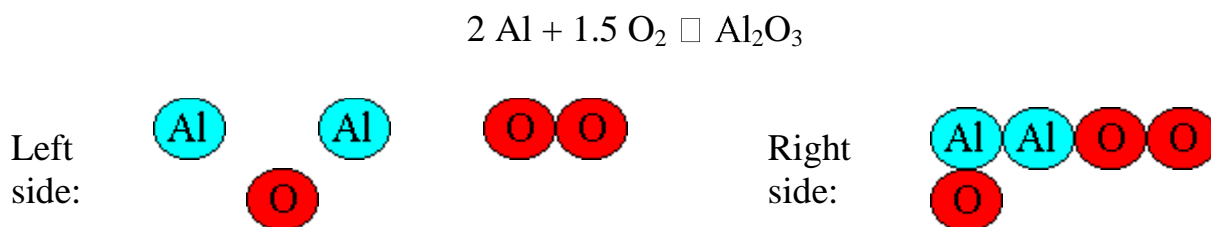

This is now balanced, but that 1.5 is a horrible thing to have in an equation - how can you have one and a half molecules? We can solve this problem by multiplying everything throughout by 2:

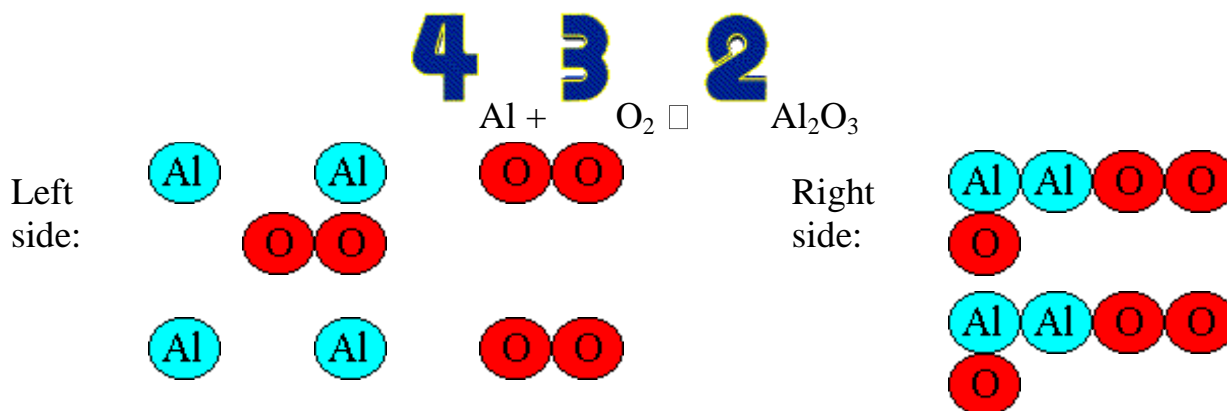

If you count the number of atoms on each side, you will find that there are four aluminium atoms on each side and six oxygen atoms. Sorted!

Another Example

Here's another equation:



Ethane is a gas similar to methane (town gas or natural gas) which burns in oxygen to give carbon dioxide gas and steam. The steam is simply water in gaseous form and condenses to form water droplets. Here is the chemical equation rewritten with the chemical symbols:



Neither the carbon, nor the oxygen atoms nor the hydrogen atoms match. Let's look at the carbon atoms first. There are two carbon atoms on the left side, but only one on the right, so we need to put a 2 in front of the carbon dioxide molecule to give two carbons on each side:



Now we will look at the hydrogen atoms. There are six hydrogen atoms on the left side and two on the right side, so we treble the number of water molecules on the right side:

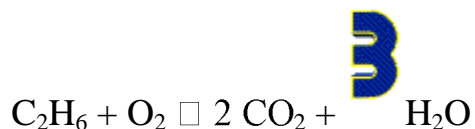

Now there are two carbon atoms on each side, and six hydrogen atoms on each side, but the oxygen atoms don't match. There are 2 of them on the left side and 7 on the right side. This is easily solved by multiplying the oxygen molecule on the left side by 3.5 (as $2 \times 3.5 = 7$):



This gives 2 carbons, 6 hydrogens and 7 oxygens on each side of the equation. The equation is balanced, but rather inelegant since it contains a decimal. Just double all the figures in the equation:



The equation has been balanced. You will notice that we left the oxygen atoms until last. This was deliberate, as oxygen was present on one side of the equation as an element (i.e. on the left side of the equation there is oxygen present in an element, not in a compound).

Treat standard groups as an item

You may recognise some standard parts of molecules, ... erm, sorry, *species*, ... as being a unit. For instance all sulphates contain the group of atoms SO_4 . These may be doubled (or even trebled) if necessary. Some examples of sulphates are shown below:

FeSO_4	Iron(II) sulphate
Na_2SO_4	Sodium sulphate
$\text{Fe}_2(\text{SO}_4)_3$	Iron (III) sulphate
$\text{Pb}(\text{SO}_4)_2$	Lead (IV) sulphate

You will notice that iron forms two sulphates, depending on its oxidation state. Being a transition metal, it can form different types of ion, Fe^{2+} and Fe^{3+} in this case. Lead also forms different ions, but I have just quoted one of its sulphates. To show that the sulphate ion is a single group, it is usually included in brackets when it has to be doubled, so iron (III) sulphate is generally written as $\text{Fe}_2(\text{SO}_4)_3$ rather than $\text{Fe}_2\text{S}_3\text{O}_{12}$.

If you can recognise a standard group, such as sulphate, phosphate, nitrate *etc.*, then you should treat it as an indivisible item. It isn't essential to do this, *i.e.* you can still balance the equation successfully even if you treat each atom individually, but treating groups as special items makes life a little easier.

If you are in any doubt, you could temporarily replace the group with a neutral letter such as X (which is not the symbol of a chemical element). Once the equation is balanced, put the group back into place, remembering to insert brackets if necessary. Take the reaction where iron (III) oxide is put in sulphuric acid:



Let's make life easier by replacing **SO₄** with **X**:



Now we can balance the equation fairly easily:



Replacing **X** with **SO₄** gives the final equation:



N.B. The approach of treating standard groups as an item only works if those groups remain unscathed throughout the reaction. If you find that a sulphate species is broken up (perhaps into an oxide of sulphur), then you can't use this approach. This is why balancing chemical equations is so much easier if you have some knowledge of the reactions going on.

Balance the elements last!

You should leave the elements that appear *as* elements anywhere in the equation until last. This is because you can balance these elements without affecting any other elements. Here's an example:

Under certain circumstances, carbon dioxide can be made to react with hydrogen gas to produce methane and water vapour (which can be electrolysed to produce oxygen and hydrogen - what a way to produce fuel!)



Let's do this the wrong way - let's balance the hydrogen first! There are two hydrogen atoms on the left (present in the hydrogen molecule) and six on the right, so we put a 3 in front of the hydrogen molecule on the left:



Now there are six hydrogen atoms on each side. The carbon atoms are balanced, one on each side, so we only have to balance the oxygen atoms.

There are two on the left side, and one on the right side. Better put a 2 in front of the water vapour molecule on the right side:

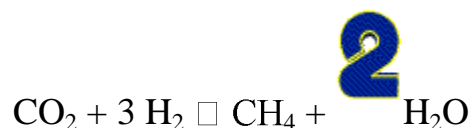

But now the hydrogens are unbalanced again! We either have to increase the number in front of the hydrogen molecule on the left side or add more methane molecules on the right side. Either way, putting a number in front of the water vapour has changed *both* the hydrogen and the oxygen.

The proper way to do it would be to balance the carbons and oxygens and *then* the hydrogens. Here's the original equation:

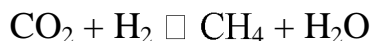

The carbons are balanced so let's concentrate on the oxygens. There are two on the left and one on the right, which is easily remedied:

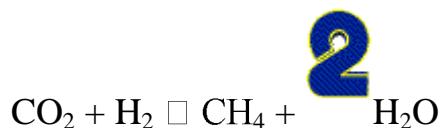

The only element which isn't balanced is hydrogen, which can be balanced without affecting any other elements. There are now eight hydrogen atoms on the right side and only two on the left, so we need to multiply the hydrogen on the left by 4:



Now all the elements are balanced, and we didn't have to rebalance anything we had previously balanced.

Balancing equations - a summary

When balancing equations, there are several things you should bear in mind:

1. You may only put numbers in front of molecules, never altering the formula itself.



2. Don't worry if the numbers turn out to be fractions - you can always double or treble all the numbers at a later stage.

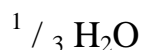

3. Balance complicated molecules with lots of different atoms first. Putting numbers in front of these may mess up other molecules, so use the simpler molecules to adjust these major changes.
4. If you recognise the atoms making up a standard group such as sulphate, nitrate, phosphate, ammonium *etc.* that survive unscathed throughout the chemical reaction, treat them as an indivisible item to be balanced as a whole. This makes life easier and helps understanding of the chemistry.
5. Leave molecules representing elements until last. This means that any numbers you put in front of those molecules won't unbalance any other molecule.

States of Matter

To make a chemical equation complete, the state of matter of each substance should also be included.

This indicates whether the substance is:

(s)	solid
(l)	liquid
(g)	gas
(aq)	aqueous (dissolved in water)

In this example, solid magnesium ribbon burns in oxygen gas to form solid magnesium oxide:

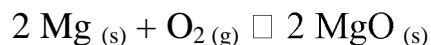

Some equations for you to balance

In each of the following questions you will see a blank box before the symbol of each compound and element. Enter the appropriate number in each box, or leave the box blank if you think the chemical needn't have a number (i.e. the number is equivalent to '1'). When you think each equation is balanced, click on the small gray button that appears below it.

- Hydrogen and nitrogen react together to produce ammonia gas (note that the reaction is a reversible one - ammonia also breaks up to form hydrogen and nitrogen):



- Propane burns in oxygen to produce carbon dioxide and steam (water vapour):



When heated, aluminium reacts with solid copper oxide to produce copper metal and aluminium oxide:



- When sodium thiosulphate solution is mixed with brown iodine solution, the mixture rapidly becomes colourless as the iodine is converted to colourless sodium iodide:



- Potassium oxide is not a stable compound. In the presence of water (or even water vapour in the air), it readily converts into potassium hydroxide:



- a double salt consisting of a trivalent metal ion and a group I metal ion. In this case the alum is potassium iron(III) thiocyanate. The thiocyanate ion is formed from a carbon and a nitrogen atom (the standard cyanide ion) together with a sulphur atom:



- When heated ammonium carbonate breaks down into gaseous ammonia, carbon dioxide and steam. In this case, you should treat NH_3 as being a single unit (ammonia) that is combined with a hydrogen atom to form the ammonium ion (NH_4).



- Here's an easy one, the burning of hydrogen gas in oxygen to form steam (which then condenses to form water).



- Magnesium will react with phosphorus to form magnesium phosphide, a chemical widely used in industry.



- When calcium chloride reacts with silver nitrate solution, a white precipitate (solid) of silver chloride appears. This is because silver chloride is insoluble: when silver ions and chloride ions find themselves together in solution, they immediately react together to form the solid. This leaves the calcium ions and nitrate ions in solution, effectively forming calcium nitrate solution.



I HOPE YOU DIDN'T FIND THESE EXAMPLES TOO DIFFICULT

HERE ARE THE ANSWERS:

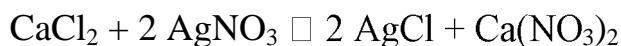
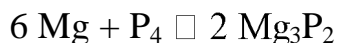
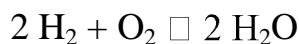
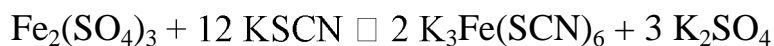
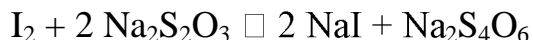
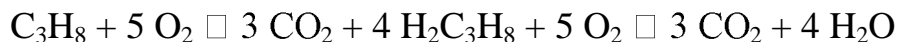

MIXTURES

A mixture contains more than one substance – such as elements and compounds or elements or compounds.

It is important to understand the DIFFERENCE between MIXTURES AND COMPOUNDS

We can understand this by looking at the reaction between iron powder and sulphur.

A mixture of iron powder and sulphur looks completely different from the individual elements.

The mixture has the individual properties of iron and sulphur – for instance – we can use a magnet to remove all the iron powder from the iron and sulphur mixture.

Substances in a mixture have not undergone a chemical reaction so we can separate them depending on the differences in their physical properties.

If the mixture of iron and sulphur is heated, a chemical reaction occurs and a new chemical substance is formed called iron (II) sulphide.

The table below summarizes the different properties of iron, sulphur, an iron/sulphur mixture and iron(II) sulphide.

SUBSTANCE	APPEARANCE	EFFECT OF A MAGNET	EFFECT OF DILUTE HYDROCHLORIC ACID
IRON	Dark grey powder	Attracted to it	Very little when cold. When warm, gas made with lots of bubbles
SULPHUR	Yellow powder	None	No effect when hot or cold
IRON/SUPLHUR MIXTURE	Dirty yellow powder	Iron powder attracted	Iron powder reacts as above
IRON (II) SULPHIDE	Dark grey solid	No effect	A foul smelling gas is produced

Here is a very important table that summarizes the differences between mixtures and compounds

MIXTURE	COMPOUND
Contains two or more substances	It is a single substance
Composition can vary	The composition is always the same
No chemical change takes place when mixture is formed	When the new substance is formed it always involves a chemical change
The properties are those of individual elements	The properties are very different to those of the component elements
The components can be easily separated by physical means	The components can only be separated by one or more chemical reactions

SEPARATING MIXTURES

Many mixtures contain useful substances mixed with unwanted material such as impurities. We therefore have to separate useful substances from unwanted substances.

The separation technique that we use depends on what is in the mixture and also the properties of the substances present. It also depends on whether the substances to be separated are solid, liquid or gas.

SEPARATING SOLID/LIQUID MIXTURES

If a **SOLID** substance is **SOLUBLE** it will **DISSOLVE** in a **LIQUID** and form a **SOLUTION**. The solid that an dissolve in the liquid is called a **SOLUTE**.

The liquid that has the power to dissolve the solid is called the **SOLVENT**.

Example: sugar dissolves in water when you make a cup of tea or coffee.

Sometimes, the solid does not dissolve in the liquid and is **INSOLUBLE**.

Example: tea leaves themselves do not dissolve in water.

FILTRATION

This is used when an insoluble solid needs to be separated from a liquid. Sand can be separated from a mixture with water by filtering through a filter paper.

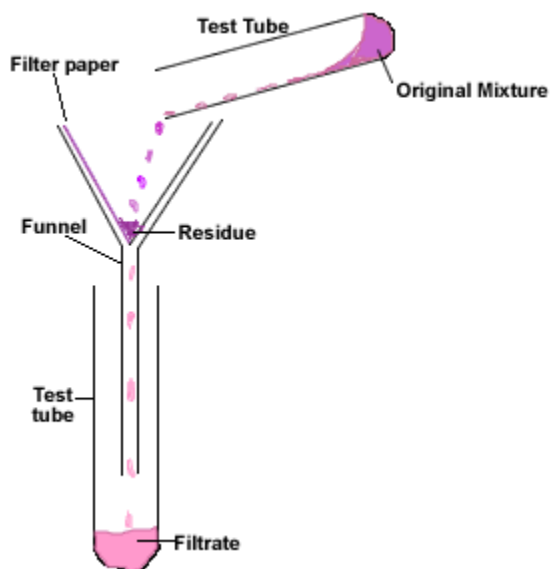

The filter contains microscopic holes that allow the small water molecules through but trap all the larger sand molecules. It acts like a sieve. The sand is called the **RESIDUE** on the filter paper and the **FILTRATE** is the liquid that is allowed to pass through the filter paper.

DECANTING

Let us think about cooking rice. It is easy to separate the cooked rice from the water by pouring off all the water. This is called decanting.

Decanting is often used to separate an insoluble solid (that may have settled at the bottom of a container) from a liquid.



Here you can see a clear liquid being decanted from an undissolved solid in the conical flask.

CENTRIFUGING

This can separate a solid from a liquid also. The technique is often used instead of filtration. It is often used when the **SOLID** Particles are too small that they **SPREAD OUT** in the solution and form a **SUSPENSION**.

They **DO NOT SETTLE** to the bottom of the container (as heavier particles would do under the force of gravity).

The technique of centrifuging involves the suspension being **SPUN AROUND VERY FAST** in a centrifuge so that the **SOLIDS GET FLUNG TO THE BOTTOM OF THE TUBE**.

The pure liquid is decanted after the solids have been forced to the bottom of the tube. This method is extensively used to separate **PLASMA FROM BLOOD CELLS**.



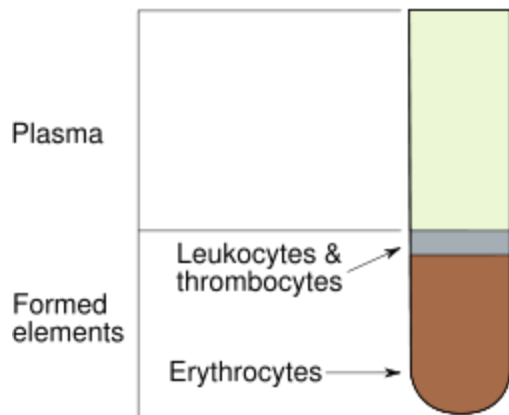

EVAPORATION

If the solid has dissolved in the liquid we cannot filter or use a centrifuge. We heat the liquid so that the liquid evaporates and leaves the solid behind. This technique is commonly used to obtain salt from salty water.

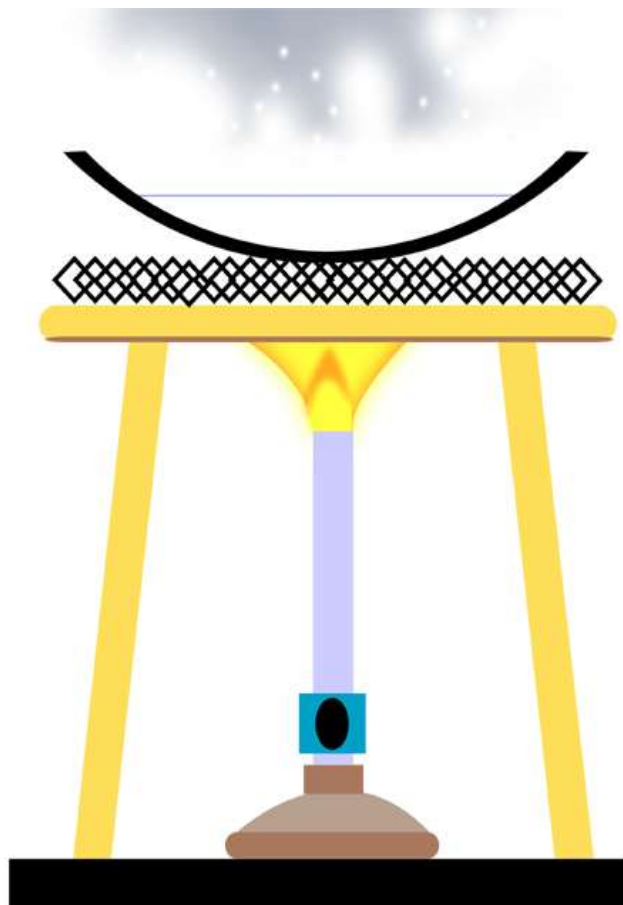

CRYSTALLISATION

In Jordan, the Dead Sea contains enormous amounts of dissolved salt in water – so much that you can float in the Dead Sea.

We can obtain salt from salt water by using the heat of the sun to evaporate the water to leave a SATURATED SALT SOLUTION called BRINE.

This is good at preserving food. Tuna fish is often stored in brine.

A SATURATED SOLUTION IS A SOLUTION THAT CONTAINS AS MUCH DISSOLVED SOLUTE AS POSSIBLE AT ANY GIVEN TEMPERATURE.

When the solution is saturated, the salt begins to CRYSTALLIZE and can be REMOVED.

Here is a salt evaporation pond



SIMPLE DISTILLATION

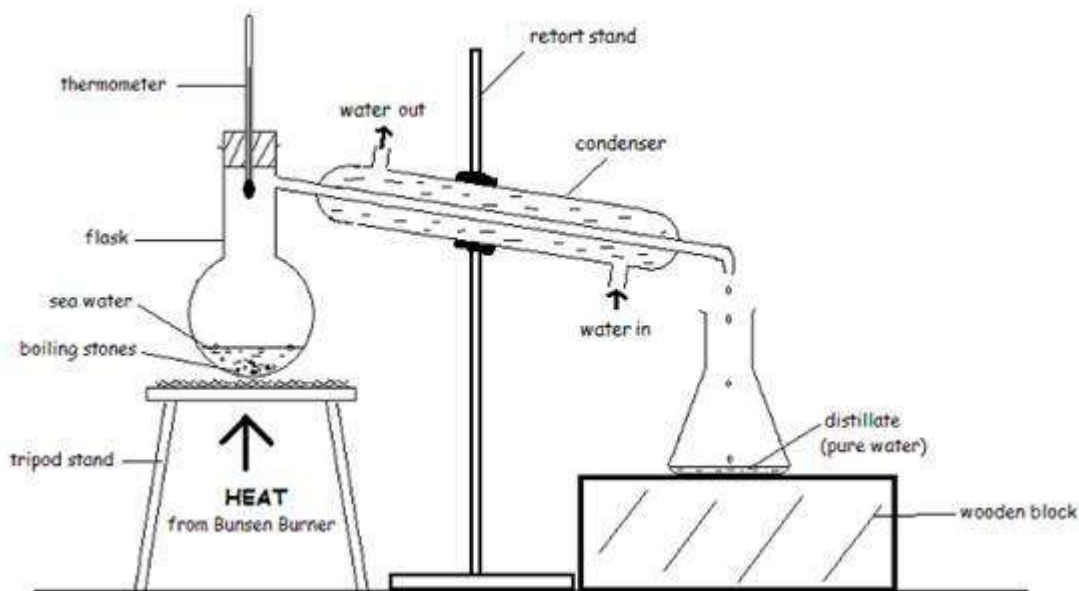

If we want to get a solvent from a solution, we carry out simple distillation using the above apparatus. We can use simple distillation to obtain pure water from salt water.

The solution is heated in the flask.

The steam rises to the condenser where it condenses back into water again.

The salt is left behind in the flask.

This is done on a large scale in desert countries like Saudi Arabia to obtain pure water for drinking. This is called DESALINATION.

SEPARATING LIQUID/LIQUID MIXTURES

Oil and water do not mix. They are IMMISCIBLE.

Liquids that do mix like water and ethanol are said to be MISCIBLE.

LIQUIDS WHICH ARE IMMISCIBLE

Two immiscible liquids can be separated using a separating funnel.

The mixture is poured into the funnel and the layers are allowed to be separated.

The heavier lower layer can then be removed by opening the tap.

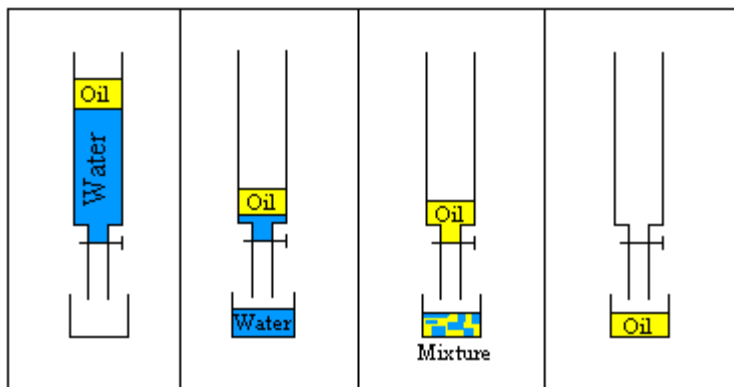

LIQUIDS WHICH ARE MISCIBLE

If miscible liquids need to be separated, this is done by **FRACTIONAL DISTILLATION**.

The apparatus used for this process is shown below.

The apparatus could be used to separate a mixture of ethanol and water.

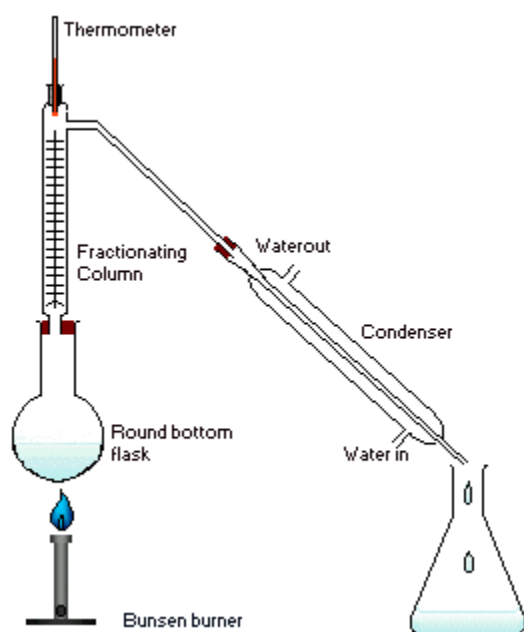

Fractional distillation is used to separate liquids that have differences in boiling point. Ethanol boils at 78 Celsius and water boils at 100 Celsius.

When the mixture is heated, the vapour is mainly ethanol with some steam in it. Water has the higher boiling point and condenses out of the mixture. This takes place in the fractionating column.

The water condenses and moves back down into the conical flask. The ethanol vapour moves up the column and into the condenser. The ethanol vapour returns to ethanol liquid and is collected in the conical flask at the end. When all of the ethanol has been separated, the temperature steadily rises to 100 Celsius. This means steam now enters the condenser. We changed the conical flask and collect the pure water that condenses over.

Fractional distillation can also be used to obtain pure gases from liquid air.

SEPARATING SOLID/SOLID MIXTURES

A magnet can be used to separate iron from sulphur. Also a large electromagnet can be used to separate iron from scrap metals.

It is **ESSENTIAL** that you pay very special attention to the properties of the individual solids you wish to separate.

Separating a mixture of iodine and salt requires you to sublime the iodine.



In the diagram, the iodine sublimates and leaves pure salt in the bottom of the beaker.

CHROMATOGRAPHY

This process is commonly used when we have to separate a mixture of coloured materials like inks and dyes.

There are many types of chromatography. The simplest type of chromatography is **PAPER CHROMATOGRAPHY**.

PAPER CHROMATOGRAPHY

Here is an example – separating the colours that make black ink.

A spot of the ink is placed onto a piece of chromatography paper . the paper is then put into a suitable solvent – such as water.

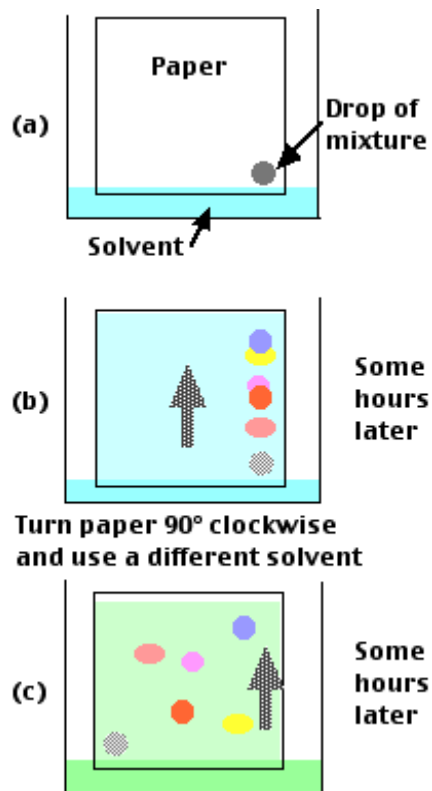

As the solvent moves up the paper, the dyes become carried with it and begin to separate. They separate due to them having differences in solubility in the solvent. They are absorbed in different amounts by the chromatography paper. They separate as they move up the chromatography paper. The end product of chromatography is called a **CHROMATOGRAM**.

The substances on which you perform chromatography do not need to be coloured. Colourless substances are made visible by covering them in a **LOCATING AGENT**. The locating agent will react with the colourless substances to form a coloured product.

Sometimes a type of chromatography is used which separates out substances due to differences in **CHARGE**. This process is known as **ELECTROPHORESIS** and can be used in forensic science to separate samples of proteins.

SOLVENT EXTRACTION

Sugar can be obtained from crushed sugar cane by adding water. The water dissolves the sugar from the sugar cane. This is called SOLVENT EXTRACTION.

Also some substances present in grass – such as chlorophyll – can be removed from crushed grass by using a powerful solvent called ethanol.

CRITERIA OF PURITY

Drugs and pharmaceuticals must be made with an extremely high degree of purity. To do this, the drugs are dissolved in a suitable solvent and then have fractional distillation performed on them.

Also, it is illegal to put anything harmful into food.

To make sure that a substance is pure we use the following things:

1. MELTING POINT – If the substance is pure, it will have a sharp, defined melting point.
2. BOILING POINT – If the substance is pure, the substance will remain steady at its boiling point and the temperature will not rise.
3. CHROMATOGRAPHY – If it is a pure substance, it will produce only one well-defined spot on the chromatogram.

GELS,SOLS,FOAMS AND EMULSIONS

These are all examples of mixtures which are formed by mixing two substances which cannot actually mix. These mixtures are often referred to as COLLOIDS.

Colloids are formed by millions of suspended particles.

Generally, colloids cannot be separated by filtration as the size of the dissolved particles is usually smaller than the holes/pores in the filter paper.

Fruit jelly and custard are examples of gels

Emulsion paint is an example of a sol

Foam could be shaving foam

Emulsions are like milk or mayonnaise

When you mix a solid with a liquid you sometimes get a gel.

A GEL IS A SEMI-SOLID WHICH CAN MOVE AROUND BUT NOT AS FREELY AS A LIQUID.

A SOL is similar to a gel but the mixture WILL FLOW such as emulsion paint or PVA glue.

When you pour out a glass of fizzy pop, the top of the liquid in the glass is a mixture of gas/liquid called a FOAM.

Emulsions are mixtures of **IMISCIBLE LIQUIDS – SUCH AS OIL AND WATER.**

To make emulsions like mayonnaise, an **EMULSIFIER** is added to stop the droplets joining back together again and forming a separate layer.

The emulsifier that is used in mayonnaise is egg yolk.

A colloidal suspension can be **DESTROYED** by bringing the dissolved particles **TOGETHER**. This is called **FLOCCULATION**.

An example of flocculation is **WATER TREATMENT**.

During water treatment, aluminium sulphate is added to water (prior to filtering) to remove suspended solids that are in the water.

MIXTURES FOR STRENGTH – COMPOSITE MATERIALS

Composite materials combine the properties of two components to get perfect properties needed for the substance to perform a special job.

Glass reinforced plastic (GRP) is an example of a composite material.

It is made by embedding short glass fibres into a plastic.

The glass fibres give the plastic extra strength so it does not break when it is bent or moulded into shape.

The GRP is very light (like plastic) but has strength and flexibility like the glass fibres.

Bones in the human body are also composite materials.

They are formed from protein strands called collagen mixed with a hard mineral called calcium phosphate.

Wood is also a composite material. It is made from cellulose fibres mixed with lignin. Lignin makes the wood strong.

TOPIC 2 – ELEMENTS, COMPOUNDS AND MIXTURES – CHECKLIST

After studying topic 2 – you should learn and understand all the following terms.

ATOM – The smallest part of an element that can exist in a stable form

CENTRIFUGING – The separation of the components of a mixture by rapid spinning. The denser particles are flung to the bottom of the container tubes. The liquid can then be decanted off.

CHEMICAL CHANGE – A permanent change in which a new substance is formed

CHEMICAL FORMULA – A shorthand method of representing the chemical elements and compounds

CHROMATOGRAPHY – A technique used to separate mixtures of dissolved substances

COLLOID – systems in which there are two or more phases. One of the phases is distributed within the other.

COMPOSITE MATERIALS – Materials which combine the properties of two substances in order to get the exact properties that are required for a special job.

COMPOUND – A substance formed by the combination of two or more elements in fixed proportions

CRYSTALLIZATION - the process in which crystals are formed from a liquid

DECANTING – The process of removing a liquid from a solid that has settled or from an immiscible liquid by pouring

DIATOMIC MOLECULE – A molecule containing two atoms – such as hydrogen gas or oxygen gas

DISTILLATION – The process of boiling a liquid then condensing the vapour produced back into a liquid. It is used to purify liquids and to separate mixtures of liquids.

ELEMENT – A substance that cannot be split into a simpler substance

EMULSION – The apparent mixing of two immiscible liquids by the use of an emulsifier which breaks down one of the liquids into tiny droplets. The droplets of the liquid float suspended in the other liquid so that they do not separate out into different layers.

EXOTHERMIC REACTION – A chemical reaction that produces heat

FILTRATE – the liquid that passes through the filter paper during filtration

FLOCCULATION – the destruction of a colloidal suspension by clumping the dispersed particles together.

FOAM – a mixture formed between a gas and a liquid. The has forms tiny bubbles in the liquid but does not dissolve in it.

GEL – A mixture formed between a solid and a liquid in which the solid forms a network which traps the liquid so it cannot flow freely

IMMISCIBLE – When two liquids form two layers when they are mixed together the layers are said to be immiscible (don't mix)

INSOLUBLE – When a solute will not dissolve in a solute, it is insoluble

INSTRUMENTAL TECHNIQUES – These are instrumental methods of analysis which are very useful when the sample is tiny. Examples are spectroscopy techniques.

LAW OF CONSTANT COMPOSITION – Compounds always have the same elements joined together in the same proportions

METALS – A class of chemicals which have a shiny appearance and which are good conductors of heat and electricity.

MISCIBLE – When two liquids form a homogenous layer when mixed together are said to be miscible.

MIXTURE – A system of two or more substances that can be separated by physical means.

MOLECULE – A group of atoms that are chemically joined together.

TOPIC 3 – ATOMIC STRUCTURE AND THE PERIODIC TABLE

Three particles are found inside atoms. They are found in distinct regions. The positive protons and neutral neutrons are found in the **CENTRAL NUCLEUS**.

The nucleus of an atom only takes up a very small amount of space in the atom but all **THE ATOMIC MASS** is centered in the nucleus – so the nucleus is very dense.

The rest of the volume of the nucleus is where the negative electrons are likely to be found. The electrons have a negative charge and move around in levels of energy called **ELECTRON SHELLS** or **ENERGY LEVELS**.

The electrons are held within the atom by an **ELECTROSTATIC FORCE OF ATTRACTION** between themselves and the positive charge of the protons in the nucleus.

1840 electrons are equal to the mass of a proton. The characteristics of a proton, neutron and an electron are shown in the table below:

PARTICLE	SYMBOL	RELATIVE MASS	CHARGE
Proton	e	1	+1
Neutron	n	1	0
Electron	e	1/1840	-1

NOTE: the masses of All the sub-atomic particles are measured in atomic mass units (amu). This is because they are so light that their masses cannot be measured usefully in grams.

A typical atom is shown below:

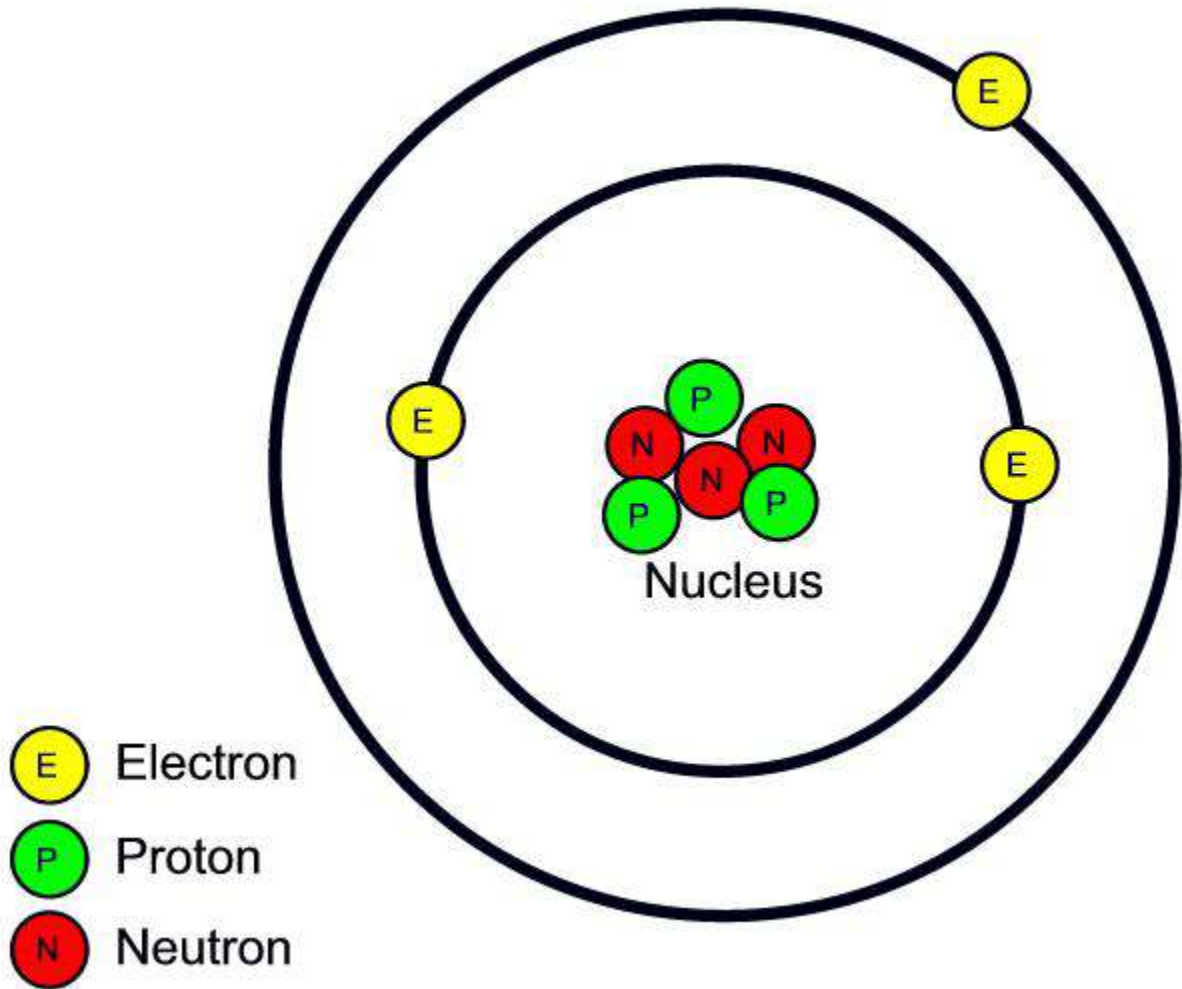

To describe the amount of protons, neutrons and electrons in an atom, scientists use two numbers called the PROTON NUMBER AND MASS NUMBER

Mass number is often called NUCLEON NUMBER

Here is the information about the element Krypton in the periodic table.

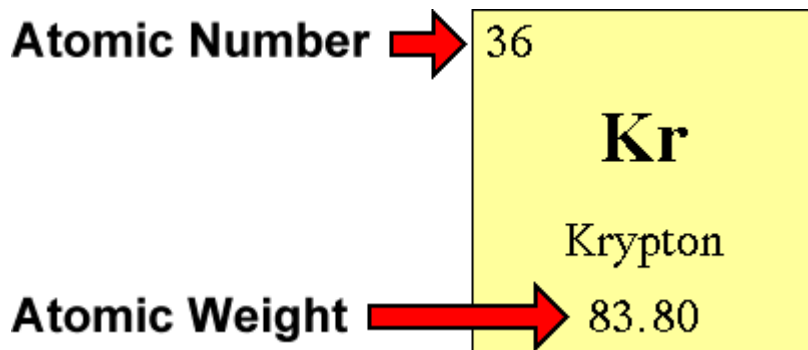

The Atomic weight is the same as the NUCLEON NUMBER – NUMBER OF PROTONS AND NEUTRONS IN THE NUCLEUS.

ATOMIC NUMBER IS THE NUMBER OF PROTONS

THE DIFFERENCE IN THE 2 NUMBERS IS NUMBER OF NEUTRONS

We can see that the element has ZERO CHARGE. This means that NUMBER OF PROTONS EQUALS NUMBER OF ELECTRONS.

In the example above, there are

84 PROTONS AND NEUTRONS (WE ROUND UP TO 84)

We have 36 protons, 36 electrons and (84-36) 48 neutrons.

The atomic number is used to put the elements in the periodic table in a logical order. The atomic structures of elements 1 to 20 in the periodic table are shown overleaf.

ELEMENT	PROTON NUMBER	NUCLEON NUMBER	NUMBER OF PROTONS	NUMBER OF NEUTRONS	NUMBER OF ELECTRONS
Hydrogen	1	1	1	0	1
Helium	2	4	2	2	2
Lithium	3	7	3	4	3
Beryllium	4	9	4	5	4
Boron	5	10	5	5	5
Carbon	6	12	6	6	6
Nitrogen	7	14	7	7	7
Oxygen	8	16	8	8	8
Fluorine	9	19	9	10	9
neon	10	20	10	10	10
Sodium	11	23	11	12	11
Magnesium	12	24	12	12	12
Aluminium	13	27	13	14	13
Silicon	14	28	14	14	14
Phosphorus	15	31	15	14	15
Sulphur	16	32	16	16	16
Chlorine	17	35.5	17	18 or 20	17
Argon	18	40	18	22	18
Potassium	19	39	19	20	19
Calcium	20	40	20	20	20

NOTE THAT HYDROGEN IS THE ONLY ELEMENT WITH ZERO NEUTRONS

ISOTOPES

Isotopes are ATOMS OF THE SAME ELEMENT THAT HAVE DIFFERENT NUMBERS OF NEUTRONS.

Isotopes of Carbon

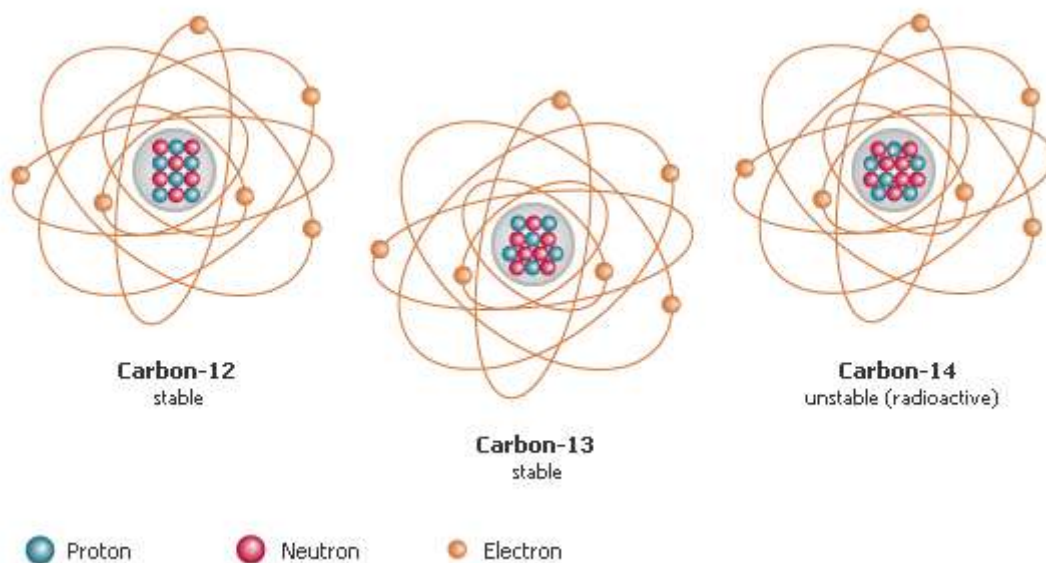

Isotopes of an element are atoms of the element that have different numbers of neutrons in their nuclei. Carbon has three naturally occurring isotopes, which are shown here with the isotopes of hydrogen. The isotopes of carbon are carbon-12, which constitutes 98.89 of all carbon atoms and serves as the standard for the atomic mass scale; carbon-13, which is the only magnetic isotope, making it very important for structural studies of compounds containing carbon; and carbon-14, which is produced by cosmic rays bombarding the atmosphere. Carbon-14 is radioactive, with a half-life of 5760 years. The amount of carbon-14 remaining in historical artifacts can be used to estimate their age.

In the above 3 examples, all the isotopes have 6 protons and 6 electrons.

Carbon-12 has 6 neutrons

Carbon-13 has 7 neutrons

Carbon-14 has 8 neutrons

The element IS ALWAYS CARBON. NEUTRON NUMBER CHANGES.

Isotopes have the same chemical properties but slightly different physical properties.

Some isotopes are RADIOACTIVE. This radioactivity comes from the NUCLEUS and the nucleus DECAYS. If the radiation is an α or β particle, they change into OTHER ATOMS WITH DIFFERENT NUMBERS OF PROTONS AND NEUTRONS.

Isotopes that do not decay and emit radioactive particles are called NON-RADIOACTIVE ISOTOPES.

Radioactive isotopes emit one of the following types of radiation

ALPHA PARTICLES (α) ARE HELIUM NUCLEI WHICH ARE 2 PROTONS AND 2 NEUTRONS.

BETA PARTICLES (β) ARE FAST MOVING ELECTRONS

GAMMA RAYS (γ) ARE HIGH ENERGY ELECTROMAGNETIC X-RAYS

The gamma rays that are formed are the most dangerous types of radioactive radiation as they can travel for the longest distances in air. They also can penetrate materials such as skin and bones.

Gamma rays can also be incredibly useful as they can sterilize medical equipment in hospitals and can also be used to treat cancer.

THE ARRANGEMENT OF ELECTRONS IN ATOMS

The electrons are arranged in energy levels called ELECTRON SHELLS which orbit the nucleus. The shells do not always contain the same number of electrons.

The first shell closest to the nucleus can hold TWO electrons. The next shell away from the nucleus can hold EIGHT electrons.

Oxygen has a proton number of 8. This means it has 8 electrons.

Two electrons will be in first shell, the other 6 in the second shell.

The electron arrangement for oxygen is written as 2,6.

Calcium has a proton number of 20.

2 electrons go in the first shell, 8 go in the second shell, 8 go in the third shell and the remaining two go in the fourth shell.

It is interesting to note that for elements 1-20 (apart from hydrogen and helium), **THE LAST NUMBER IN THE ELECTRON ARRANGEMENT IS THE SAME AS THE GROUP OF THE PERIODIC TABLE THAT THE ELEMENT IS IN.**

The electron arrangement for Calcium can be written as 2,8,8,2

This arrangement ends in 2. This is the group number for calcium.

The electron arrangement is very important as it determines the way that the atom chemically reacts.

ATOM DIAGRAMS

19: Potassium

2,8,8,1

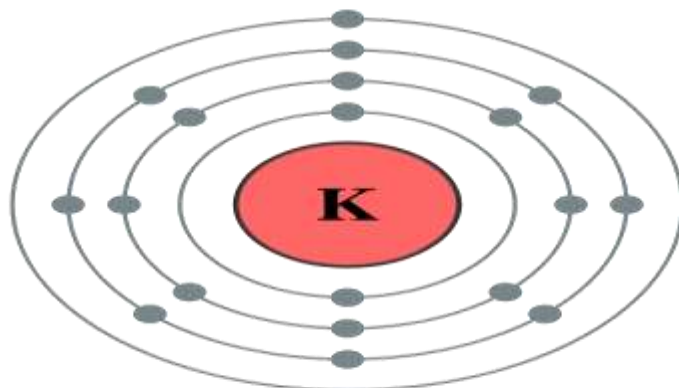

THESE DIAGRAMS SHOW ELECTRON ARRANGEMENTS.

THE NOBLE GASES

This is a group of very unreactive non-metals. They used to be called the inert gases but it is **INCORRECT** to use this term now because even though they were supposed to be completely unreactive – Xenon was found to react with fluorine and form a compound called xenon tetrafluoride XeF_4

This compound was formed artificially in a laboratory under very extreme conditions. As far as your lab is concerned, they are totally unreactive but it would be preferred if you called them Noble Gases.

The reason that noble gases are completely unreactive is due to their electronic structures. The atoms **ALL HAVE COMPLETELY FULL OUTER ELECTRON SHELLS**. They do not need to lose electrons like metals do or gain electrons like non-metals do.

VALENCY ELECTRONS

When atoms combine to make a new compound, they try to get a full outer shell of electrons. For metals to do this, it is easier for them to lose electrons than it is for them to gain extra ones. For non-metal, the reverse is true and it is easier for them to gain extra electrons as they are usually in groups 5 to 8 – losing 5 is harder than gaining 3, 2, or 1 electrons.

Sometimes, elements can even share their outer shell electrons. You will discover this in the bonding topic later.

The number of electrons in the outer electron shell is called **VALENCY ELECTRONS**. This is the same as the group number of the element in the periodic table.

Here is an example of this

Carbon has 4 electrons in the outer shell. It therefore shares 4 electrons to make a complete outer shell of 8 electrons. **CARBON HAS 4 VALENCY ELECTRONS**.

BONDING – THE STRUCTURE OF MATTER

John Dalton in 1808 published his findings on the THEORY OF ATOMS.

There were 5 key points he proposed

1. All matter is made of small invisible spheres called ATOMS
2. All the atoms of the same element are IDENTICAL and with SAME MASS
3. The atoms of DIFFERENT ELEMENTS have DIFFERENT MASSES
4. Chemical COMPOUNDS are formed when ATOMS JOIN TOGETHER
5. All molecules of a chemical compound have the SAME TYPE AND NUMBER of atoms

A MIXTURE contains MORE THAN ONE SUBSTANCE (ELEMENTS OR COMPOUNDS).

In a mixture, the separate substances can be easily separated.

If we have a mixture of iron powder and sulphur powder, all the iron can be separated from the sulphur because the iron could be attracted with a magnet.

The mixture is of 2 substances that ARE NOT CHEMICALLY BONDED TOGETHER.

Most elements are either METALS or NON-METALS. In the periodic table, the metals are arranged in groups 1 and 2 on the left hand side or as TRANSITION METALS in the MIDDLE of the periodic table.

METALLOID elements are in between the metal and non-metal elements. They have some of the typical properties of metals and some of the typical properties of non-metals.

Silicon and germanium are metalloids and are often termed SEMICONDUCTORS.

Metals and non-metals have quite different physical properties and chemical properties.

Metals, Nonmetals & Metalloids

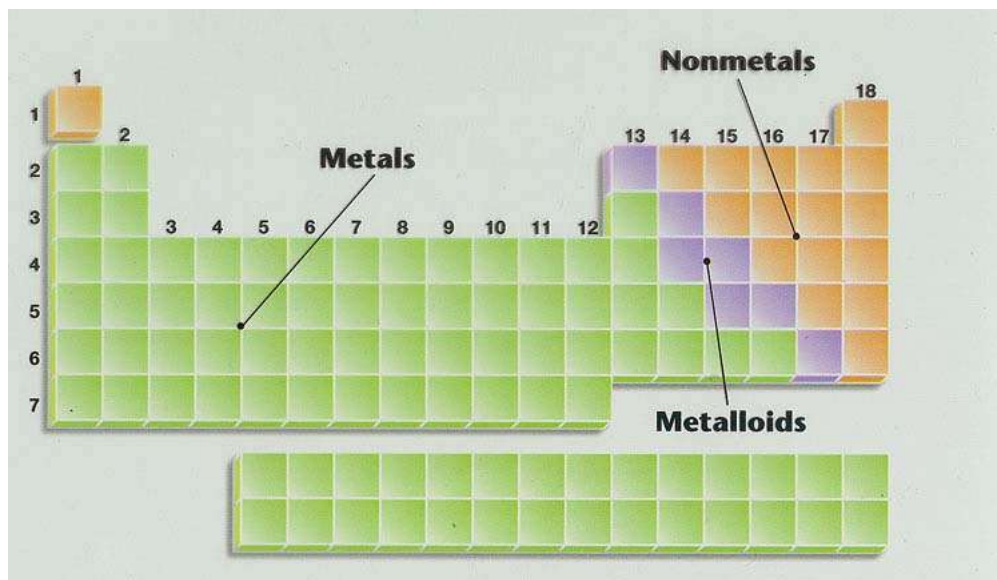

Most periodic tables contain a zigzag line which allows you to identify which elements are metals, nonmetals, and metalloids.

Metals

Most elements are metals. 88 elements to the left of the staircase line are metals or metal like elements.

Physical Properties of Metals:

- Luster (shininess)
- Good conductors of heat and electricity
- High density (heavy for their size)
- High melting point
- Ductile (most metals can be drawn out into thin wires)
- Malleable (most metals can be hammered into thin sheets)

Chemical Properties of Metals:

- Easily lose electrons
- Corrode easily. Corrosion is a gradual wearing away. (Example: silver tarnishing and iron rusting)

Nonmetals

Nonmetals are found to the right of the staircase line. Their characteristics are opposite those of metals.

Physical Properties of Nonmetals:

- No luster (dull appearance)
- Poor conductor of heat and electricity
- Brittle (breaks easily)
- Not ductile
- Not malleable
- Low density
- Low melting point

Chemical Properties of Nonmetals:

- Tend to gain electrons

Since metals tend to lose electrons and nonmetals tend to gain electrons, metals and nonmetals like to form compounds with each other. *These compounds are called ionic compounds.* When two or more nonmetals bond with each other, they form a covalent compound.

Metalloids

Elements on both sides of the zigzag line have properties of both metals and nonmetals. These elements are called metalloids.

Physical Properties of Metalloids:

- Solids
- Can be shiny or dull
- Ductile
- Malleable
- Conduct heat and electricity better than nonmetals but not as well as metals

ALLOYS

An alloy is formed when a metal is mixed with other elements

Alloy	Typical composition	Special properties	Some Uses
Steel	Fe(99%), C(1%)	Stronger than iron, and more corrosion resistant	Building materials
Duralumin	Al(95%), Cu(4%), Mn(0.5%), Mg(0.5%)	Increased hardness and tensile strength, light weight	Aircraft industry
Bronze	Cu(85%), Sn(15%)	Stronger than copper, corrosion resistant	Weapons and tools, coinage, decorations
Stainless Steel	Fe(85%), Cr(14%), Ni(1%)	Corrosion resistant	Cutlery, domestic appliances, furnace parts, nuclear reactors

Pewter	Sn(85%), Cu(7%), Bi(6%), Sb(2%)	Stronger than tin, but still easy to etch and engrave	Domestic utensils, jewelry
Manganin	Cu(81%), Mn(15%), Ni(4%)	High resistivity and low temperature coefficient	Resistors
Nichrome	Cr(80%), Ni(20%)	High resistivity and high melting point	Flame loops
Cupronickel	Cu(75%), Ni(25%)	Attractive appearance for coins, very ductile(looks like silver)	Coinage
Solder	Pb(67%), Sn(33%)	Harder than lead, with a much lower melting point	To hold other metals together
Brass	Cu(60%), Zn(40%)	More easily shaped by stamping and machining than bronze	Jewelry, doorknobs, household items
Dental amalgam	Sn(44%), Hg(33%), Ag(22%)	Resistant to corrosion from the acidic products excreted by mouth bacteria	Braces, dental work

HOW DO ATOMS REACT TOGETHER?

Atoms bond with other atoms in a chemical reaction to make a new substance called a COMPOUND.

Sodium metal will react with chlorine gas to make a new compound called sodium chloride. Hydrogen gas will react with oxygen gas to make a new compound called water.

These reactions are caused by electron arrangements in atoms. If atoms have incomplete electron shells, they will usually react with other atoms.

Only atoms with complete electron shells tend to be unreactive like the noble gases in group 8 of the periodic table.

When atoms combine, they try to achieve full outer electron shells. They do this either by gaining electrons to fill the gaps in their outer shell to make a full outer shell or lose electrons to leave a full shell behind.

IONIC BONDING

Ionic bonding involves ELECTRON TRANSFER between metals and non-metals to form FULL ELECTRON SHELLS.

Metal elements LOSE ELECTRONS and form POSITIVE METAL IONS. This is called OXIDATION.

Non-metal elements GAIN ELECTRONS and form NEGATIVE NON-METAL IONS. This is called REDUCTION.

The ions are HELD TOGETHER by strong electrical forces called ELECTROSTATIC FORCES.

The bonding process can be represented by DOT AND CROSS DIAGRAMS.

Here is the ionic bonding diagram for sodium chloride.

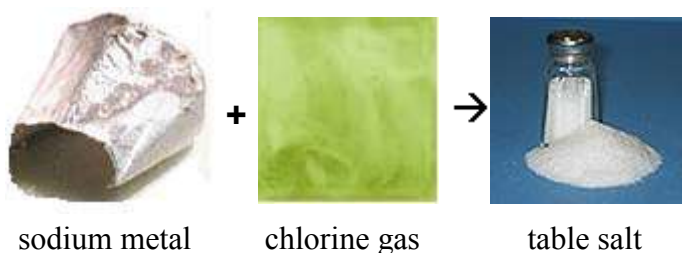

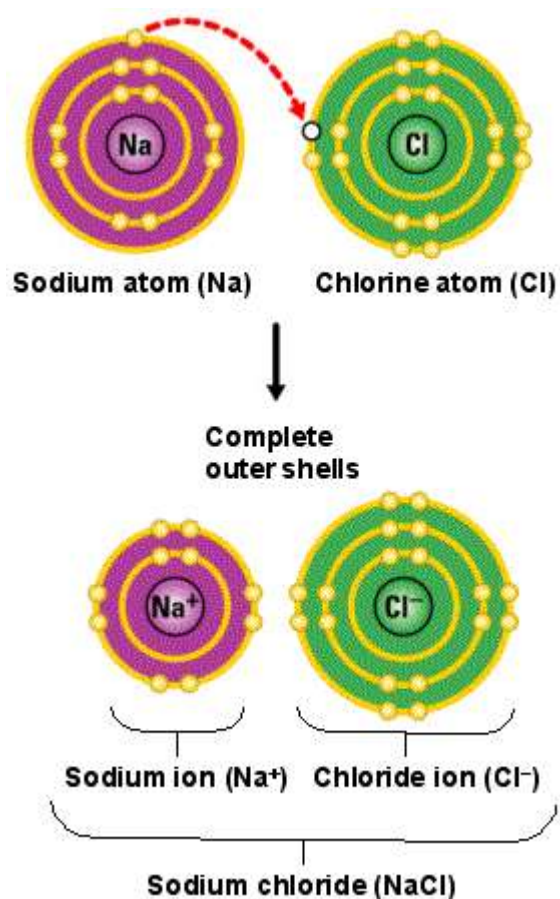

Sodium is a metal. It has a proton number of 11 so it also has 11 electrons arranged in the order 2.8.1

Chlorine is a non-metal. It has a proton number of 17 so it also has 17 electrons arranged in the order 2.8.7

Sodium has one electron in its outer shell. It can get a full outer shell of 8 electrons by losing this outer shell electron by transferring it to the chlorine atom.

Chlorine has seven electrons in its outer shell. It can get a full outer shell of 8 electrons by gaining and accepting the one electron that the sodium atom loses.

The sodium is no longer an atom. It is an ION. It now does not have an equal number of protons and electrons. It has one more proton than electron and forms a SODIUM ION WITH A +1 CHARGE.

The chlorine is no longer an atom. It is also an ION. It now does not have an equal number of protons and electrons. It now has ONE MORE ELECTRON than protons and is a CHLORIDE ION WITH A -1 CHARGE.

Metals can also transfer more than one electron to a metal.

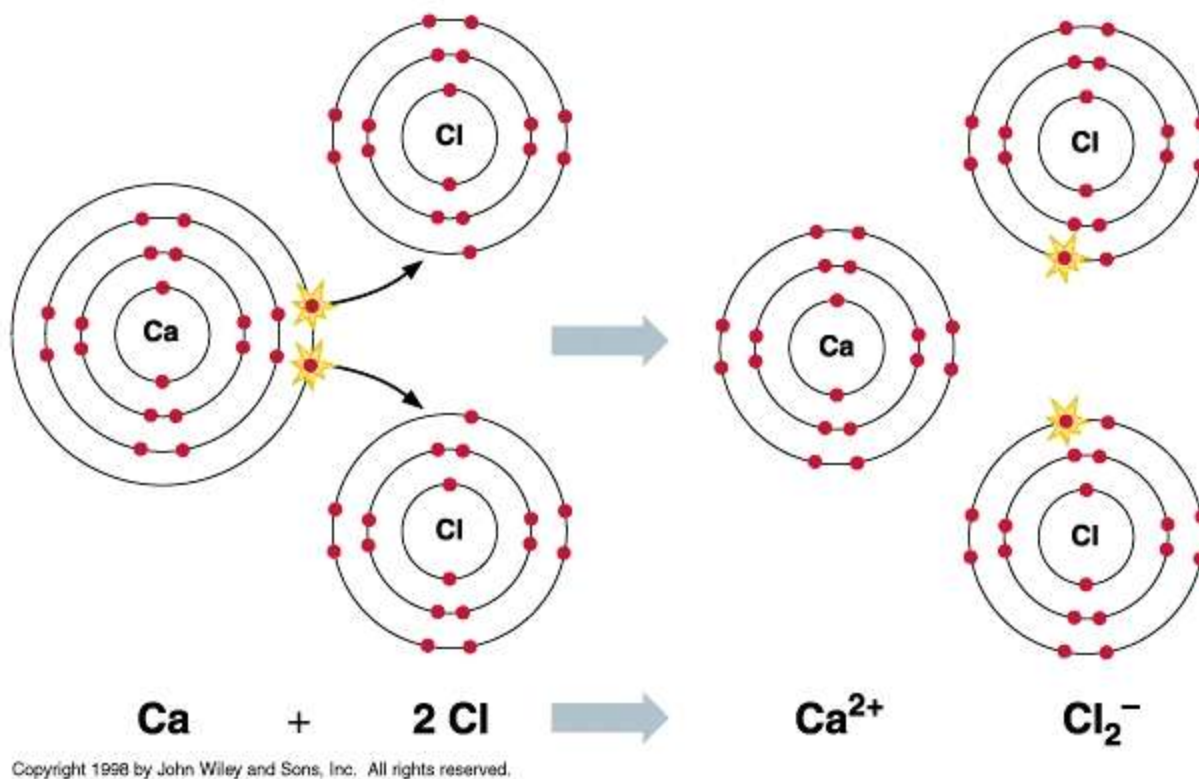

Calcium combines with oxygen to form CALCIUM CHLORIDE.

The calcium atom (2.8.8.2) transfers TWO electrons – one each to TWO CHLORINE ATOMS.

MAGNESIUM BECOMES A +2 ION.

THE TWO CHLORINES BECOME 2 CHLORIDE IONS – EACH WITH A -1 CHARGE.

Some other examples of ionic bonding

magnesium oxide



Again, noble gas structures are formed, and the magnesium oxide is held together by very strong attractions between the ions. The ionic bonding is stronger than in sodium chloride because this time you have 2+ ions attracting 2- ions. The greater the charge, the greater the attraction.

The formula of magnesium oxide is MgO.

calcium chloride

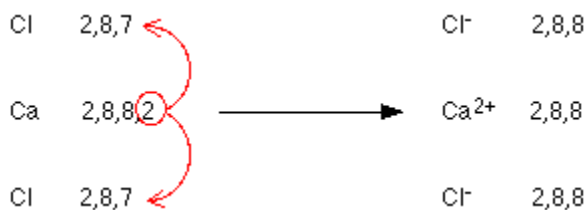

This time you need two chlorines to use up the two outer electrons in the calcium. The formula of calcium chloride is therefore CaCl₂.

potassium oxide

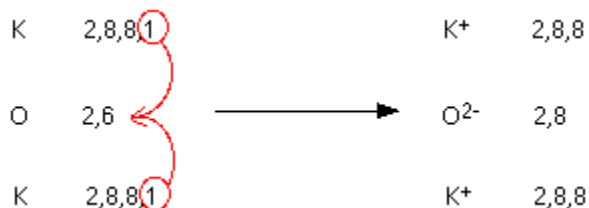

Again, noble gas structures are formed. It takes two potassiums to supply the electrons the oxygen needs. The formula of potassium oxide is K₂O.

WHAT IONS CAN AN ELEMENT FORM?

The ion that is formed by an element can be determined from the position of the element in the periodic table . Elements in Groups 4 and 8 do not form ions.

GROUP NUMBER	1	2	3	4	5	6	7	8
ION CHARGE	+1	+2	+3	X	-3	-2	-1	X

COVALENT BONDING

This type of bonding involves the sharing of electrons. It only occurs in atoms of non-metal elements. It usually forms a molecule. The non-metal atoms **SHARE** electrons to get a stable **FULL OUTER SHELL**.

A single covalent bond is formed between **TWO NON-METAL ELECTRONS**.

Hydrogen gas exists as **TWO HYDROGEN ATOMS JOINED TO FORM A MOLECULE**.

Each hydrogen atom wants to fill its electron shell. They do this by sharing electrons.

Hydrogen

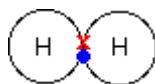

Hydrogen atoms only need two electrons in their outer level to reach the noble gas structure of helium. Once again, the covalent bond holds the two atoms together because the pair of electrons is attracted to both nuclei.

A single covalent bond can be shown by a single line. The formula for a hydrogen molecule can be written as H-H.

The hydrogen and oxygen atoms in water are also held together by covalent bonds.

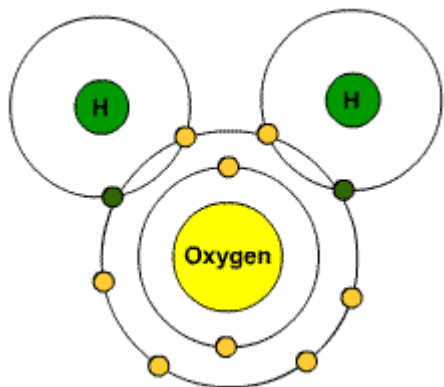

Some molecules can form **DOUBLE COVALENT BONDS** like in the covalent molecule **CARBON DIOXIDE**

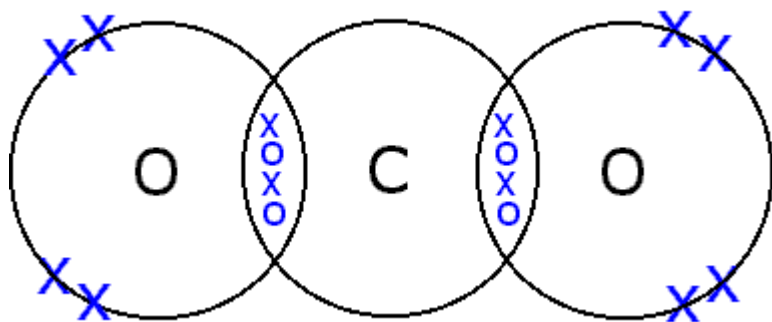

In carbon dioxide, the carbon atom has an electrical arrangement of 2,4

It needs an additional 4 electrons to complete its full outer shell. It must share its existing 4 electrons with 4 electrons from oxygen atoms to get this full shell.

TWO OXYGEN ATOMS ARE NEEDED, EACH SHARING TWO ELECTRONS WITH THE CARBON ATOM.

Here are some further examples of covalent bonding

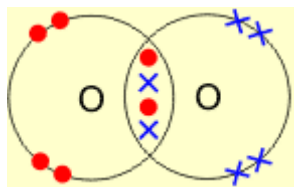

Oxygen molecule formed by two atoms sharing one pair of electrons. This is a double bond.

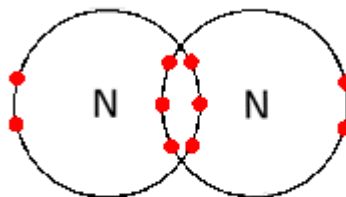

Nitrogen molecule showing three shared pairs of electrons making full outer shells with eight electrons in each. This is a triple bond

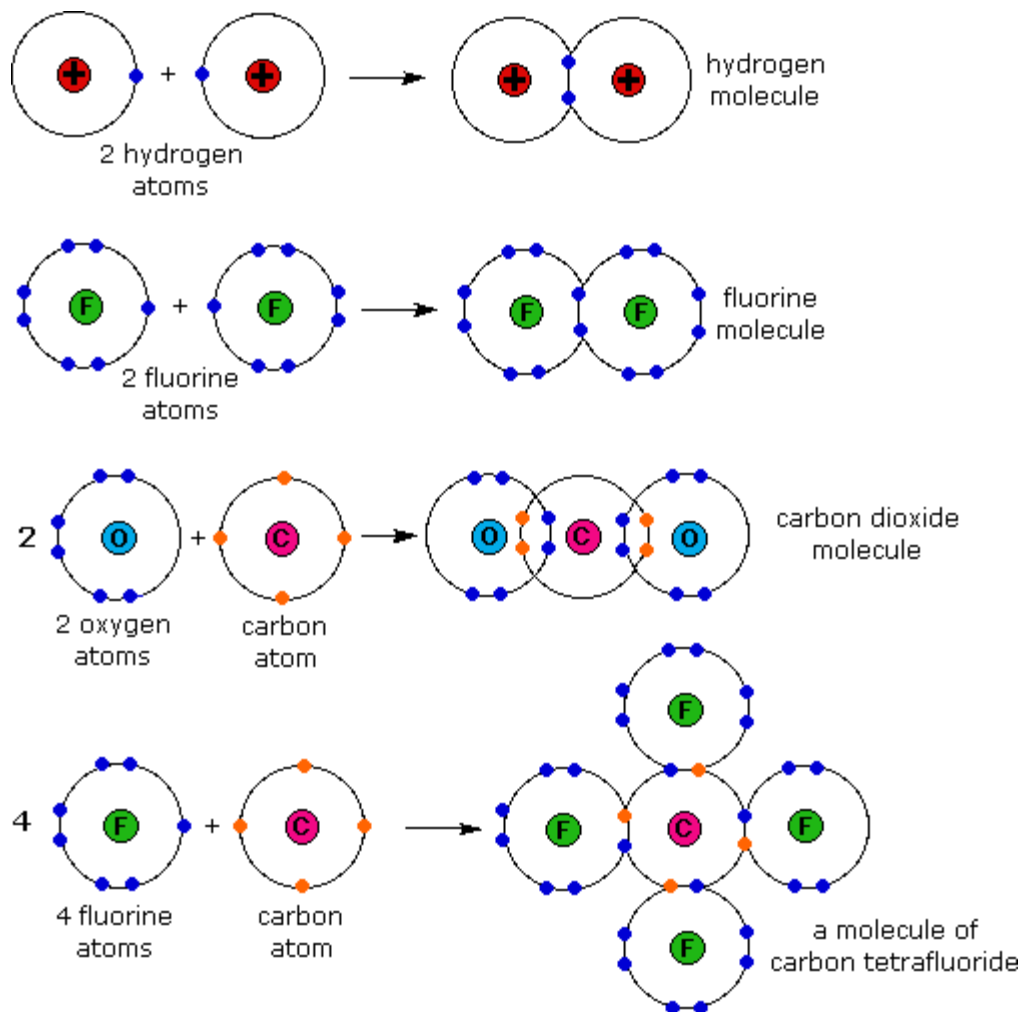

On the following page, you will see the covalent bonding in an alcohol called methanol. Things are slightly more complicated, but the rules of covalent bonding remain the same.

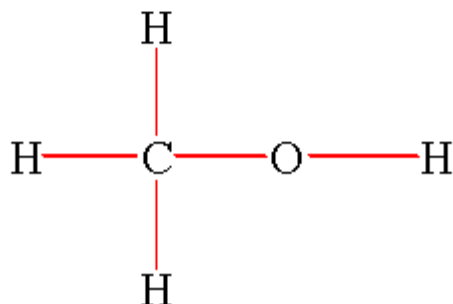
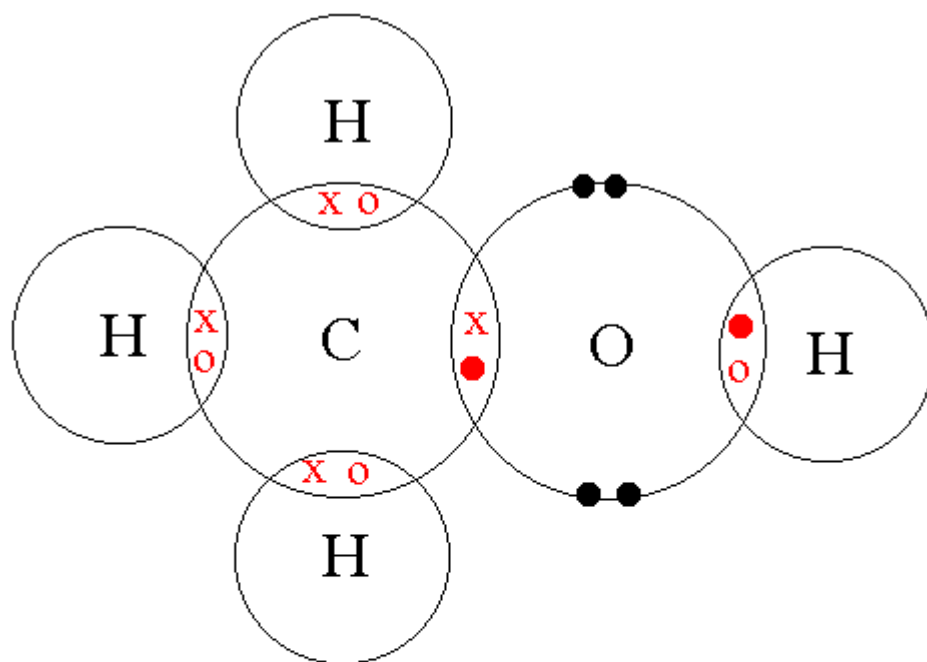

Compounds containing covalent bonds have very different properties from compounds that contain ionic bonds. We will study these differences in the next chapter.

HOW MANY COVALENT BONDS CAN AN ELEMENT FORM?

This is linked to the position of the element in the periodic table. Metals in groups 1,2 and 3 DO NOT form covalent bonds. The noble gases in group 8(0) are unreactive and do not form covalent bonds. This can be summarized in the table below:

GROUP IN PERIODIC TABLE	1	2	3	4	5	6	7	8
NUMBER OF COVALENT BONDS FORMED	X	X	X	4	3	2	1	X

X MEANS NO COVALENT BONDS AT ALL

WHAT STRUCTURES DO IONIC COMPOUNDS FORM?

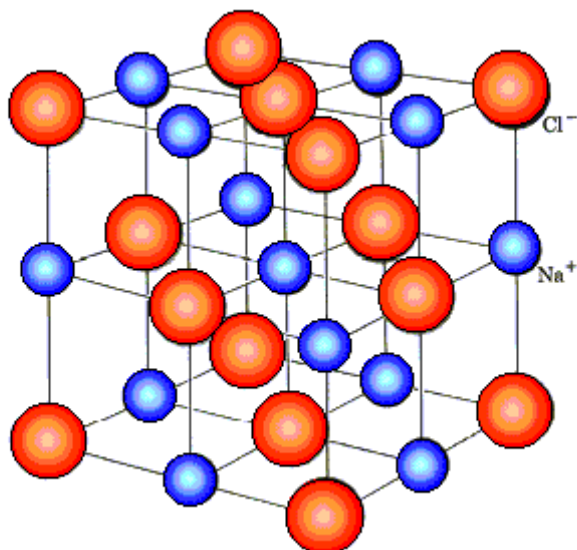

Ionic compounds form GIANT LATTICE STRUCTURES. When sodium chloride is formed by ionic bonding, the ions do not pair up. Each sodium ion is surrounded by six chloride ions. Each chloride ion is also surrounded by six sodium ions.

The electrostatic attractions between the ions are VERY STRONG.

The properties of sodium chloride can be explained just by looking at the diagram above.

PROPERTIES OF SODIUM CHLORIDE	EXPLANATION IN TERMS OF STRUCTURE
Hard crystals	Strong forces between the ions
High melting point of 801 Celsius	Strong forces between the ions
Dissolves in water	The water is also able to form strong electrostatic attractions with the ions
Does not conduct electricity when solid	Strong forces between the ions stop them from moving about
Does conduct electricity when molten or dissolved in water	The strong forces between the ions have been broken down so now the ions are free to move about

COVALENT MOLECULES

Covalent bonds are also strong bonds. They are **INTRAMOLECULAR BONDS** that are formed **WITHIN** each molecule. Much weaker **INTERMOLECULAR FORCES** attract the individual molecules towards each other.

Hydrogen Bonding in Water

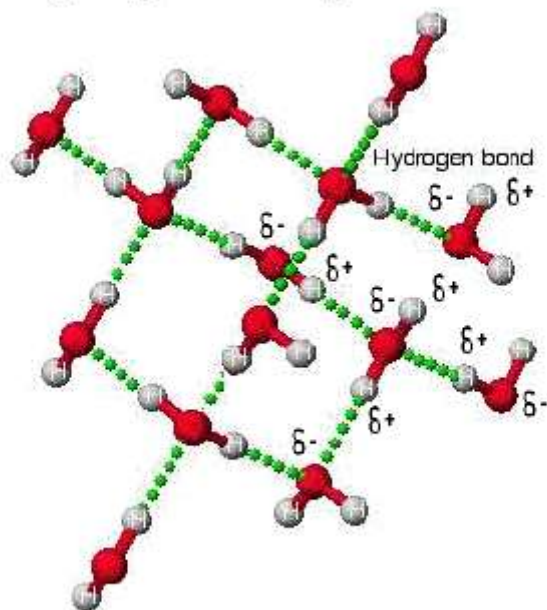

C. Ophardt, c. 2003

In the diagram on the other page, the hydrogen atoms have a **SLIGHTLY POSITIVE CHARGE**. The oxygen atoms have a **SLIGHT NEGATIVE CHARGE**. The bonds that form **BETWEEN** the water molecules are called **HYDROGEN BONDS** and are **INTERMOLECULAR** forces.

MACROMOLECULES

Some covalently bonded compounds do not exist as simple molecular structures in the way that hydrogen does. Diamond exists as a **GIANT COVALENT STRUCTURE** with each carbon atom bonded to four others.

Diamond is a **FORM** of the element **CARBON**.

DIFFERENT FORMS of the **SAME ELEMENT** are called **ALLOTROPES**.

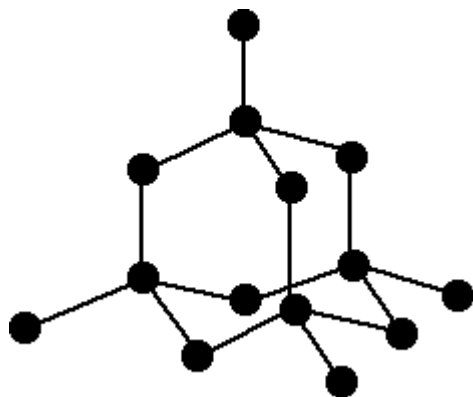

Here is a diagram to show the giant covalent bonding structure of diamond.

In the diagram some carbon atoms only seem to be forming two bonds (or even one bond), but that's not really the case. We are only showing a small bit of the whole structure.

This is a *giant* covalent structure - it continues on and on in three dimensions. It is not a molecule, because the number of atoms joined up in a real diamond is completely variable - depending on the size of the crystal.

How to draw the structure of diamond

Don't try to be too clever by trying to draw too much of the structure! Learn to draw the diagram given above. Do it in the following stages:

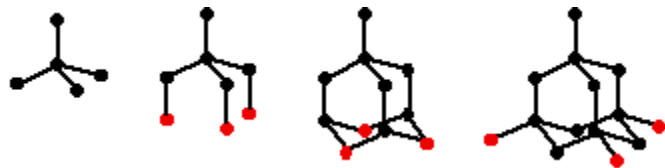

Here are the properties of diamond:

Has a very high melting point (almost 4000°C). Very strong carbon-carbon covalent bonds have to be broken throughout the structure before melting occurs

Is very hard. This is again due to the need to break very strong covalent bonds operating in 3-dimensions.

Doesn't conduct electricity. All the electrons are held tightly between the atoms, and aren't free to move.

Is insoluble in water and organic solvents. There are no possible attractions which could occur between solvent molecules and carbon atoms which could outweigh the attractions between the covalently bound carbon atoms

Diamond is also the hardest naturally-occurring material in the world. It is used for industrial drill bits to drill through metal, cut glass or drill through hard rock to find oil like in Kuwait.

Another form or allotrope of carbon is GRAPHITE.

Graphite has a different giant covalent structure:

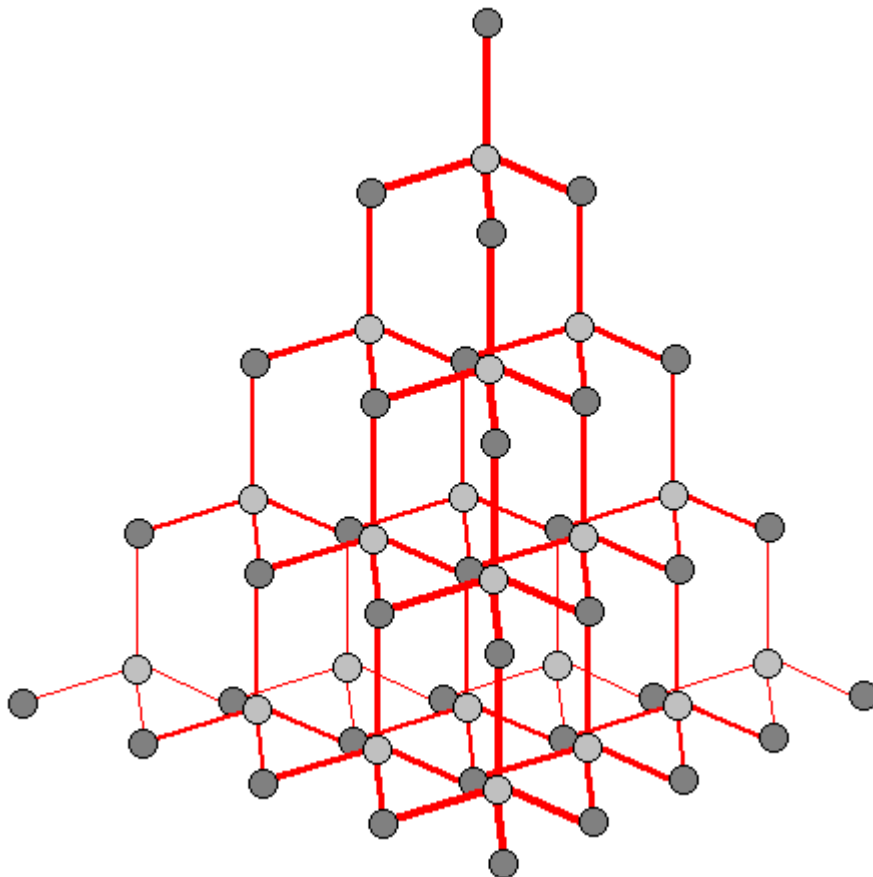

In graphite, carbon atoms form layers of hexagons in the plane of their strong covalent bonds. The weak bonds are BETWEEN the layers. The layers can SLIDE OVER EACH OTHER. Graphite is flaky and can be used as a LUBRICANT. Graphite can be used to conduct electricity (as electrodes in electrolysis as we shall see later) because the electrons are free to move along the layers.

Here is a summary of the properties of graphite:

- Has a high melting point, similar to that of diamond. In order to melt graphite, it isn't enough to loosen one sheet from another. You have to break the covalent bonding throughout the whole structure.
- Has a soft, slippery feel, and is used in pencils and as a dry lubricant for things like locks. You can think of graphite rather like a pack of cards - each card is strong, but the cards will slide over each other, or even fall off the pack altogether. When you use a pencil, sheets are rubbed off and stick to the paper.

- Has a lower density than diamond. This is because of the relatively large amount of space that is "wasted" between the sheets.
- Is insoluble in water and organic solvents - for the same reason that diamond is insoluble. Attractions between solvent molecules and carbon atoms will never be strong enough to overcome the strong covalent bonds in graphite
- Conducts electricity. The delocalised electrons are free to move throughout the sheets. If a piece of graphite is connected into a circuit, electrons can fall off one end of the sheet and be replaced with new ones at the other end.

Finally, another giant atomic structure is silicon (IV) oxide, otherwise known as silicon dioxide or sand.

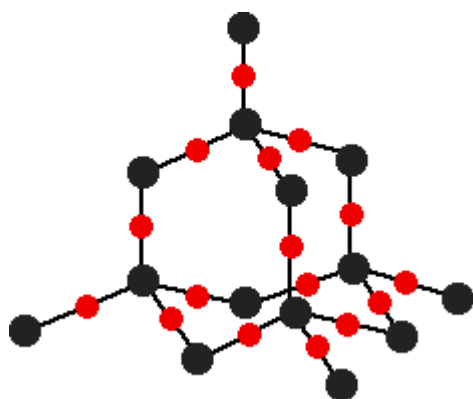

There are three different crystal forms of silicon dioxide. The easiest one to remember and draw is based on the diamond structure.

Crystalline silicon has the same structure as diamond. To turn it into silicon dioxide, all you need to do is to modify the silicon structure by including some oxygen atoms.

Notice that each silicon atom is bridged to its neighbours by an oxygen atom. Don't forget that this is just a tiny part of a giant structure extending on all 3 dimensions.

Silicon dioxide

- has a high melting point - varying depending on what the particular structure is (remember that the structure given is only one of three possible structures), but around 1700°C. Very strong silicon-oxygen covalent bonds have to be broken throughout the structure before melting occurs.
- is hard. This is due to the need to break the very strong covalent bonds.

- doesn't conduct electricity. There aren't any delocalised electrons. All the electrons are held tightly between the atoms, and aren't free to move.
- is insoluble in water and organic solvents. There are no possible attractions which could occur between solvent molecules and the silicon or oxygen atoms which could overcome the covalent bonds in the giant structure.

The 3 molecules described are also known as **MACROMOLECULES**.

Macro means enormous.

Here is a summary of the differences between Giant structures and Simple Molecular structures:

STRUCTURE	ATOM	MOLECULE	ION
Giant	Diamond graphite, metals, high melting points	Sand molecules, high melting point	All ionic compounds like sodium chloride. High melting points
Simple Molecular	Noble gases like helium. Low melting points	Carbon dioxide, water. Low melting points	None exist

METALLIC BONDING

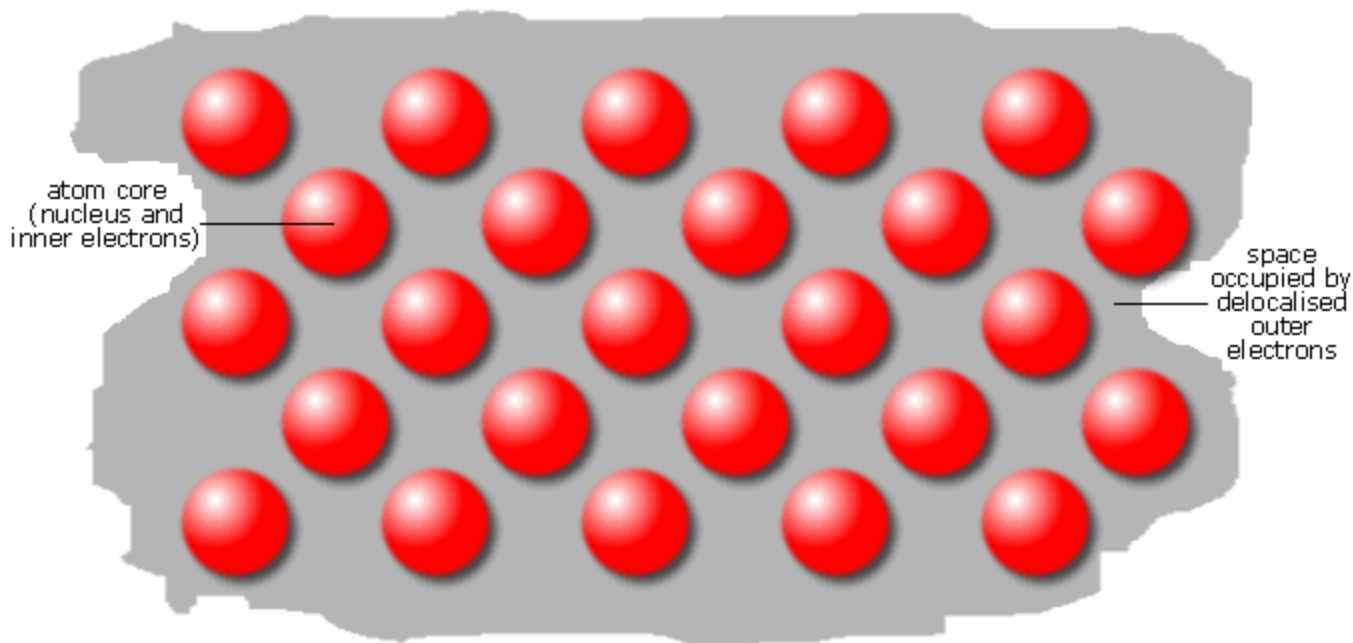

Metals are giant structures that have high melting points and boiling points (usually).

Metallic bonds are quite strong so that metal atoms are quite hard to pull apart. Metals can be beaten into sheets (malleable) due to the nature of the forces holding the metal together. Since there is no overall force or attraction between the positive cations, they can be moved from one lattice site to the other as the metals are bent or shaped.

Metal ions are closely packed in the giant structure and this accounts for the property of the metal. Metal atoms give away one or more of their outer shell electrons to form positive ions called cations. The electrons that have been given away make up a 'sea' of electrons that surround these positive metal cations.

The negative electrons are attracted to the positive cations and hold them together.

The electrons are free to move all of the way through the whole structure.

The electrons are **DELOCALISED** which means that they are **NOT IN ONE FIXED POSITION**.

TOPIC 4: STOICHIOMETRY

This is a table of all the POSITIVE METAL IONS

Valency 1		Valency 2		Valency 3	
lithium	Li ⁺	magnesium	Mg ²⁺	aluminium	Al ³⁺
sodium	Na ⁺	calcium	Ca ²⁺	iron III	Fe ³⁺
potassium	K ⁺	strontium	Sr ²⁺	chromium	Cr ³⁺
silver	Ag ⁺	barium	Ba ²⁺		
hydronium	H ₃ O ⁺	copper II	Cu ²⁺		
(or hydrogen)	H ⁺	lead II	Pb ²⁺		
ammonium	NH ₄ ⁺	zinc	Zn ²⁺		
copper I	Cu ⁺	manganese II	Mn ²⁺		
mercury I	Hg ⁺	iron II	Fe ²⁺		
		tin II	Sn ²⁺		

This is a table of all the NEGATIVE NON-METAL IONS.

Valency 1		Valency 2		Valency 3	
fluoride	F ⁻	oxide	O ²⁻	phosphate	PO ₄ ³⁻
chloride	Cl ⁻	sulphide	S ²⁻		
bromide	Br ⁻	carbonate	CO ₃ ²⁻		
iodide	I ⁻	sulphate	SO ₄ ²⁻		
hydroxide	OH ⁻	sulphite	SO ₃ ²⁻		
nitrate	NO ₃ ⁻	dichromate	Cr ₂ O ₇ ⁻		
bicarbonate	HCO ₃ ⁻	chromate	CrO ₄ ²⁻		
bisulphate	HSO ₄ ⁻	oxalate	C ₂ O ₄ ²⁻		
nitrite	NO ₂ ⁻	thiosulphate	S ₂ O ₃ ²⁻		
chlorate	ClO ₃ ⁻	tetrathionate	S ₄ O ₆ ²⁻		
permanganate	MnO ₄ ⁻	monohydrogen phosphate	HPO ₄ ²⁻		
hypochlorite	OCl ⁻				
Dihydrogenphosphate	H ₂ PO ₄ ⁻				

Included with this revision guide is a computer program entitled CHEMICAL FORMULA TUTOR.

It is a program that is included on the CD version of this book.

Run the program, select a file to unzip the files into.

Copy and paste the shortcut icon onto your desktop and away you go.

Here are webpage links to allow you to use the software:

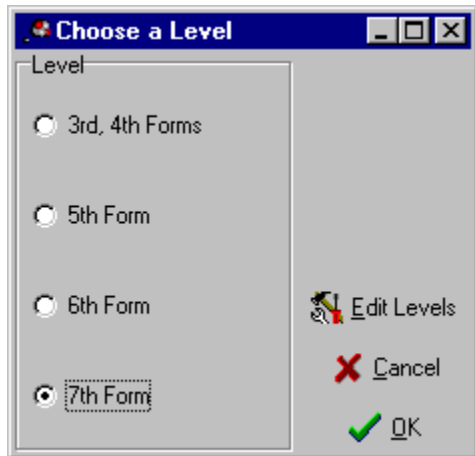

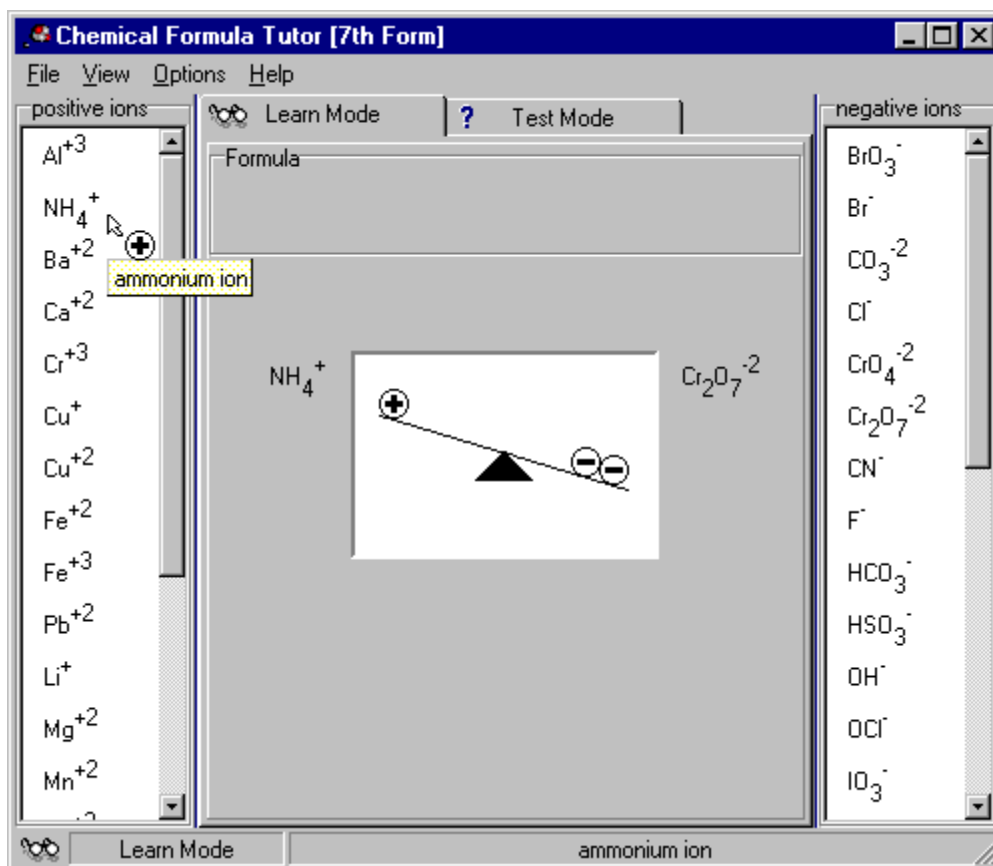

- Move the mouse cursor, Hints display the name of the ion and the cursor shows its charge.
- Double Click or Drag ions to the balance, Hints will tell you what you need to do to balance the charges.
- When the charges are being balanced, the formula of the substance will be displayed in the formula frame and an atom counter shows numbers of each type of atom.
- To find out the name of the substance move the mouse cursor to the formula frame.
- To immediately show the formula Drag the ions directly to the formula frame.

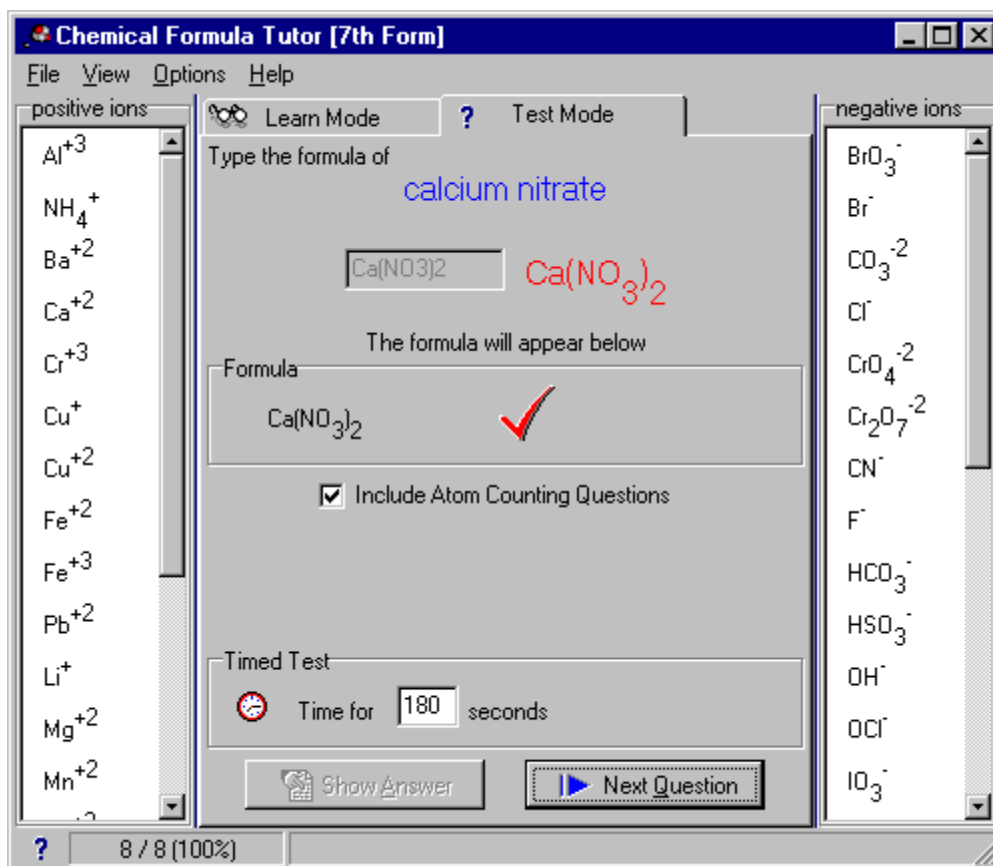

To Make the Test More Challenging

- Include or exclude Atom Counting Questions
- Testing can be done with or without the extra pressure of time
You can set how long the timed test will run for
- Hide or Show the positive and / or negative ions

Top Scores (Current User: Bruce Levett)

Percent	Correct	Out of	Name	Level	Time
100	11	11	Sarah Galland	5th Form	01 : 00
100	9	9	Bruce Levett	7th Form	01 : 00
100	8	8	Jane Macdonald	7th Form	not timed
100	6	6	Paul West	7th Form	01 : 53
100	5	5	Brian Lee	7th Form	not timed
100	5	5	Anne St George	5th Form	not timed
97	36	37	Eric Chambers	5th Form	03 : 00
30	3	10	John Adams	7th Form	00 : 30

OK

Edit Levels [7th Form]

Level

3rd, 4th Forms
 5th Form
 6th Form
 7th Form

7th Form

4 Levels 20 positive ions 27 negative ions Create a New Ion and store it alphabetically

positive ions	negative ions	Formula
Al ⁺³	BrO ₃ ⁻	Al+3
NH ₄ ⁺	Br ⁻	Ion Name
Ba ⁺²	CO ₃ ⁻²	aluminium
Ca ⁺²	Cl ⁻	
Cr ⁺³	CrO ₄ ⁻²	
Cu ⁺	Cr ₂ O ₇ ⁻²	
Cu ⁺²	CN ⁻	
Fe ⁺²	F ⁻	
Fe ⁺³	HCO ₃ ⁻	
Pb ⁺²	HSO ₃ ⁻	
Li ⁺		

Apart from using the free Chemical Formula Tutor software (by kind permission of Chemserve New Zealand), here is a simple guide to writing chemical formulae.

All substances are made from simple building blocks called chemical elements.

Each element has its own unique chemical symbol containing one or two letters. Elements that were discovered many years ago have Latin names such as

Silver is Ag from the Latin Argentum

Lead is Pb from the Latin Plumbum

When chemical elements combine together they form **COMPOUNDS**. A compound can be simplified into a chemical formula

Simple compounds

Many compounds contain just 2 elements.

Here is an example.

When magnesium burns in oxygen gas, a white ash of magnesium oxide is formed.

Here are the steps you use to work out the formula of magnesium oxide:

1. Write down the name of the compound (magnesium oxide)
2. Write down the chemical symbols for the elements in the compound (Mg and O)
3. Use the Periodic Table to find the 'combining power' of each element from the table below. Write the combining power of each element under its symbol (Mg 2, O 2)
4. If the numbers can be cancelled, cancel them (Mg O)
5. Swap over the combining powers and write down the symbols

GROUP NUMBER	1	2	3	4	5	6	7	8
COMBINING POWER	1	2	3	4	3	2	1	0

There you go, the compound magnesium oxide has the chemical formula MgO but you probably would have guessed that anyway!

What about Calcium Chloride?

1. Write down the name of the compound (Calcium Chloride)
2. Write down the chemical symbols for the elements in the compound (Ca and Cl)
3. Use the Periodic Table to find the combining power of each element. Write down the combining power for each element under its symbol (Ca1 Cl2)
4. If the numbers can be cancelled down, cancel them (they can't be)
5. Swap over the combining powers. Write them below the symbols as a subscript.
6. If the number is one – please don't write it!
7. The correct formula of calcium chloride is CaCl₂

Rules for determining combining power

GROUPS 1 TO 4 – GROUP NUMBER IS SAME AS COMBINING POWER

GROUPS 5 TO 8 – COMBINING POWER = 8 – GROUP NUMBER

If an element is not in groups 1 to 8 it will be a transition metal element. The combining power of the metal element will be POSITIVE (METAL ELEMENT) and the combining power will be included in the name of the compound.

Example Copper (II) sulphate = Copper with a combining power of 2

Sometimes an element does not have the combining power you expect it to have. Phosphorus is in group 5 so you would expect it to have a combining power of 3.

But it can form a compound called phosphorus (V) oxide in which it has the combining power of 5.

THE ONLY EXCEPTION IS HYDROGEN. COMBINING POWER ALWAYS 1

Compounds with more than two elements

Some elements exist where they are bonded together in a radical or COMPOUND ION.

The sulphate part of copper sulphate is a radical or compound ion.

The combining power of these radicals was shown in a table previously.

The same rules are used for radicals as they are with chemical elements.

Copper (II) sulphate

Both have a combining power of 2 so the formula is CuSO_4

Potassium nitrate

Both have a combining power of 1 so the formula is KNO_3

Calcium hydroxide

Calcium has a combining power of 2, hydroxide has a combining power of 1 so the formula is Ca(OH)_2

In the above example, the brackets are used just like they are in maths. The number outside the bracket multiplies everything that is inside the bracket.

WRITING AND BALANCING CHEMICAL EQUATIONS

Use the included software program to help you.

It is a 30-day trial version.

IF IT RUNS OUT IN YOUR REVISION PROGRAM AFTER 30 DAYS – JUST DELETE THE PROGRAM FROM YOUR COMPUTER AND RE-INSTALL IT ON YOUR COMPUTER AGAIN AND IT WILL CONTINUE.

In a chemical equation, the starting chemicals are called REACTANTS and the chemicals produced at the end are called PRODUCTS.

You must follow these simple rules to balance a chemical equation:

1. Write down a WORD EQUATION
2. Write down the SYMBOLS FOR ELEMENTS AND FORMULA FOR COMPOUNDS
3. BALANCE THE EQUATION making sure there are the SAME number of atoms on both sides of the equation.

Many atoms are DIATOMIC (usually gases) which means they exist as TWO atoms such as hydrogen gas H₂ and oxygen gas O₂.

TWO WORKED EXAMPLES

1. When a lighted splint is put into a tube of hydrogen gas, we hear a sound called a 'squeaky pop'. The hydrogen actually reacts with oxygen gas in the air to make water. Write a balanced chemical equation for this reaction.

WORD EQUATION: hydrogen gas + oxygen gas = water

SYMBOLS AND FORMULAE $\text{H}_2 + \text{O}_2 = \text{H}_2\text{O}$

BALANCE IT $2\text{H}_2\text{O} + \text{O}_2 = 2\text{H}_2\text{O}$

This means TWO molecules of hydrogen gas react with ONE molecule of oxygen gas to make TWO molecules of water.

2. What is the equation when natural cooking gas at home (methane) burns in air to form carbon dioxide and water?

WORD EQUATION:

METHANE + OXYGEN GAS = CARBON DIOXIDE GAS AND WATER

SYMBOLS AND FORMULAE $\text{CH}_4 + \text{O}_2 = \text{CO}_2 + \text{H}_2\text{O}$

BALANCE THE EQUATION $\text{CH}_4 + 2\text{O}_2 = \text{CO}_2 + 2\text{H}_2\text{O}$

Sample Problem

The work of balancing a chemical equation is in many ways a series of trials and errors. As a sample exercise, consider the equation given below. Does this represent a balanced chemical equation?

The work of balancing a chemical equation is in many ways a series of trials and errors. As a sample exercise, consider the equation

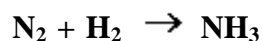
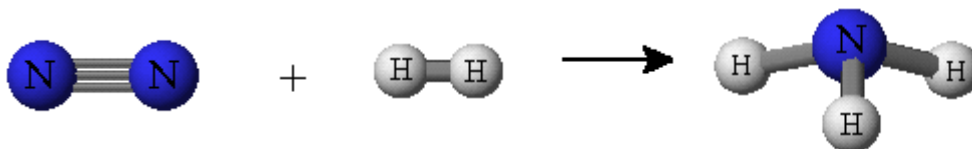

To determine whether this reaction is balanced you must first determine how many atoms of each type are on the reactant side (left-hand side) of the equation and how many atoms of each type are on the product side (right-hand side). In this example, you have two blue nitrogen atoms and two gray hydrogen atoms on the reactant side but only one nitrogen atom and three hydrogen atoms on the product side. For the purpose of balancing the equation we are not concerned what molecules these atoms are in, just the number of atoms of each type.

To balance this reaction, it is best to choose one kind of atom to balance initially. Let's choose nitrogen in this case. To obtain the same number of nitrogen atoms on

the product side as on the reactant side requires multiplying the number of product NH_3 molecules by two to give:

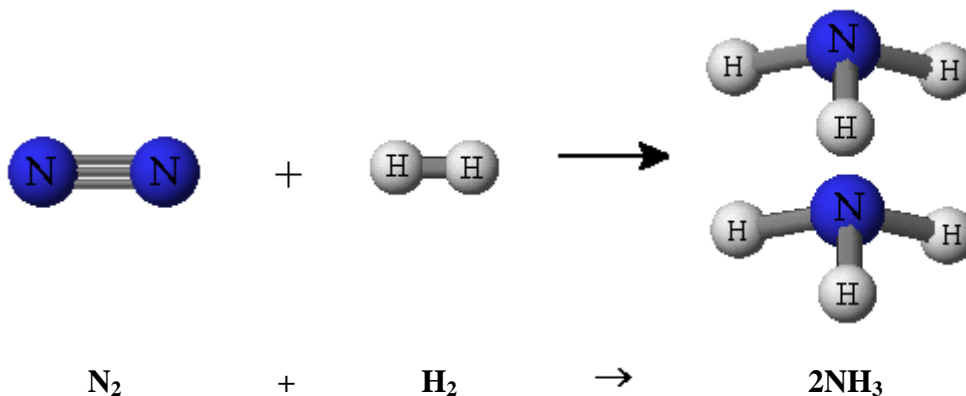

As you can see above, once we know what the molecules are (N_2 , H_2 , and NH_3 in this case) we cannot change them (only how many of them there are). The nitrogen atoms are now balanced, but there are 6 atoms of hydrogen on the product side and only 2 of them on the reactant side. The next step requires multiplying the number of hydrogen molecules by three to give:

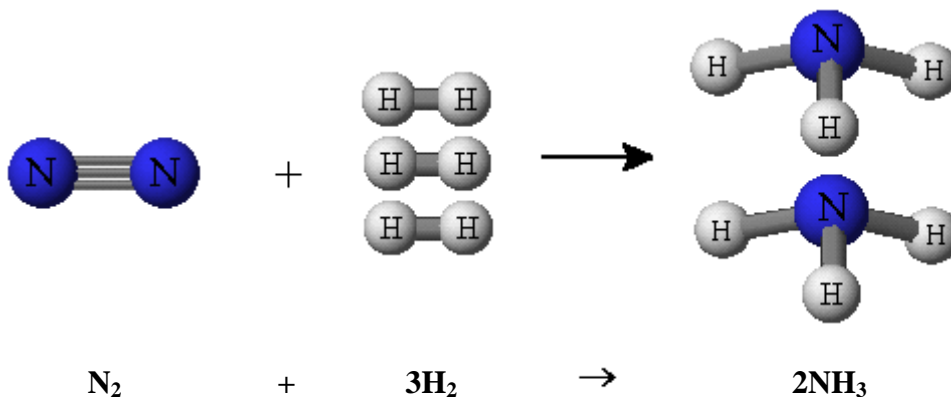

As a final step, make sure to go back and check whether you indeed have the same number of each type of atom on the reactant side as on the product side. In this example we have two nitrogen atoms and six hydrogen atoms on both sides of the equation. We now have a balanced chemical equation for this reaction.

Here are 5 examples for you to try yourself

Reaction #1

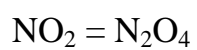
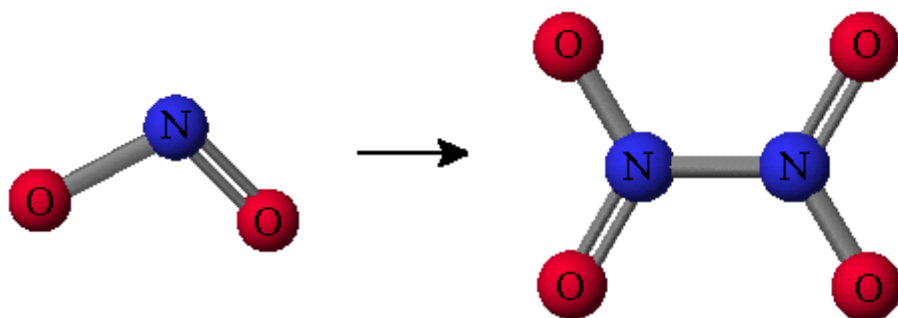

Reaction #2

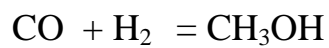
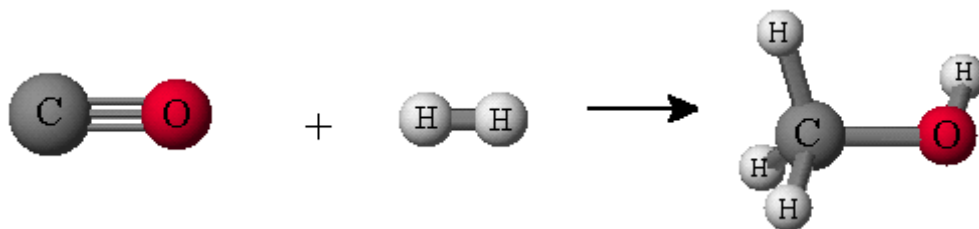

Reaction #3

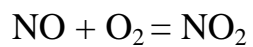
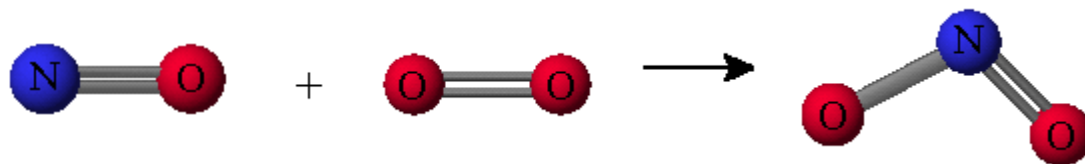

Reaction #4

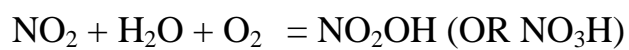
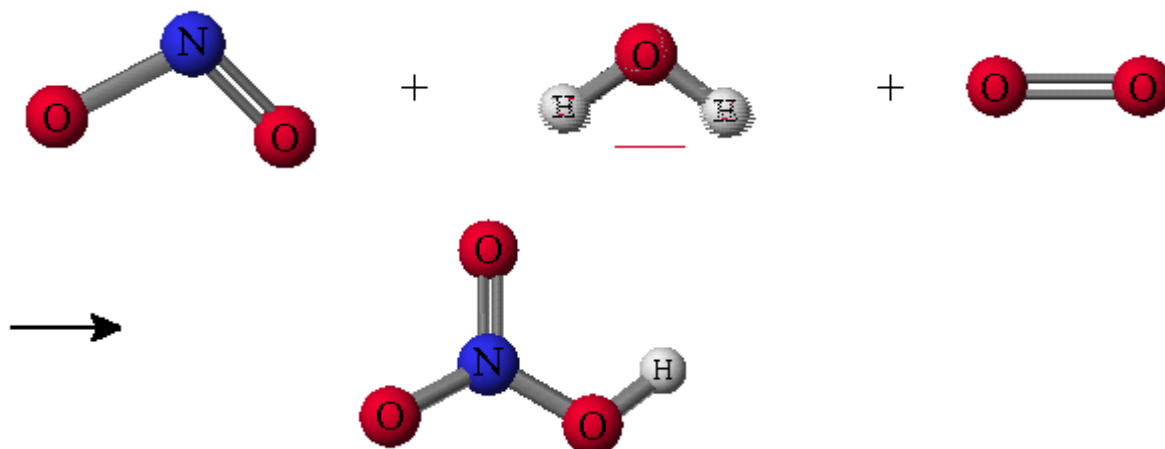

Reaction #5

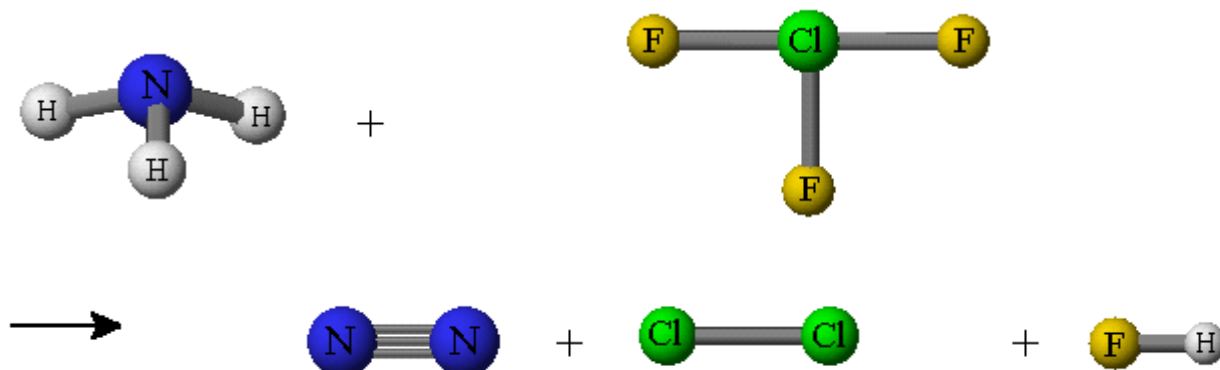

Reaction #6

This is the first step in the industrial production of nitric acid, HNO₃.

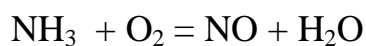
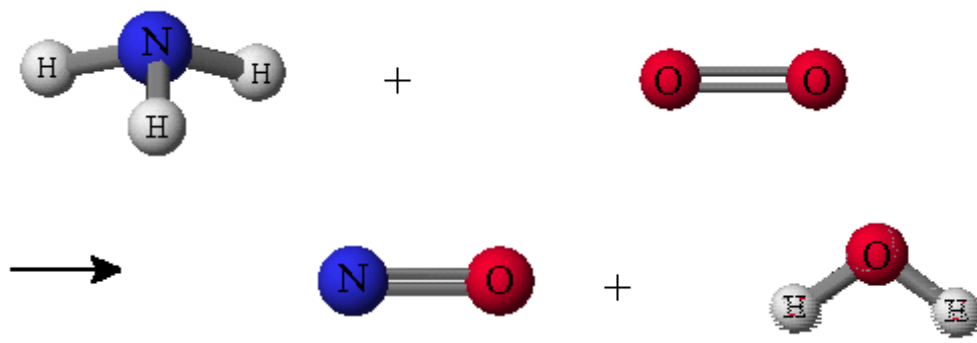

There are some other reactions called combustion where the chemical reacts in OXYGEN GAS.

These are very common chemical reactions and the 4 equations are commonly found on IGCSE Exam Papers!!!

Reaction #7

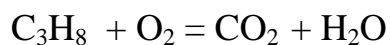
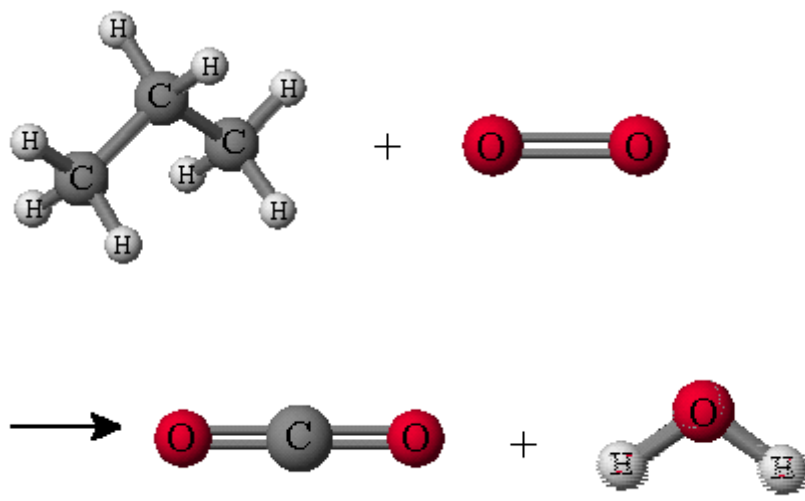

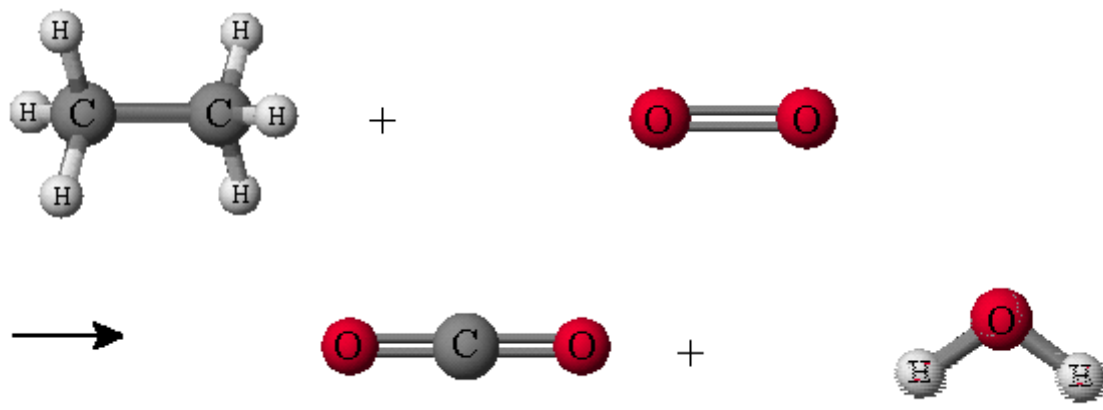
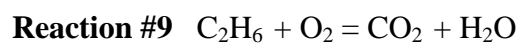
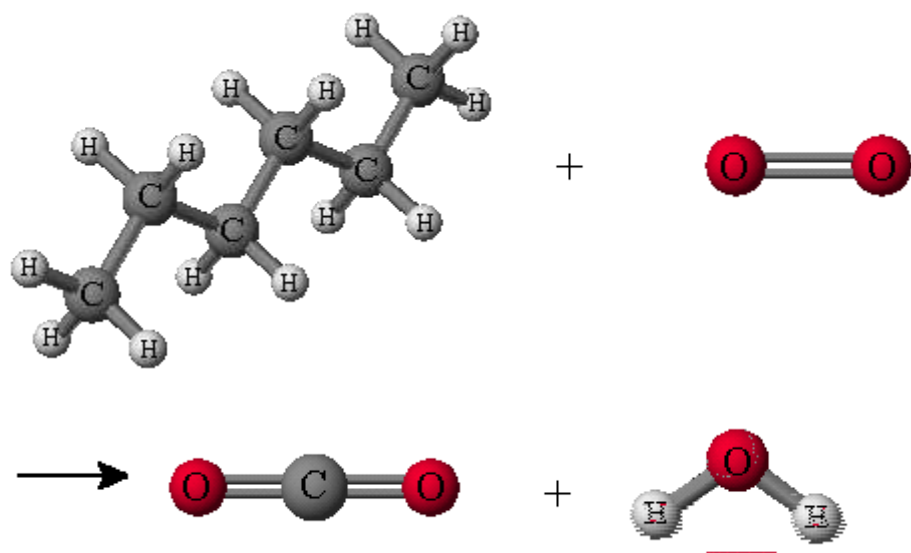
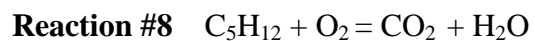

ANSWERS

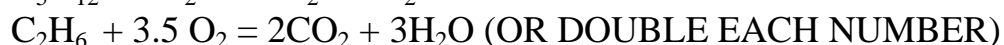
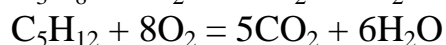
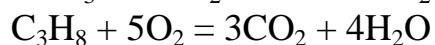
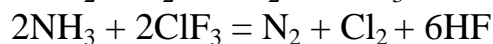
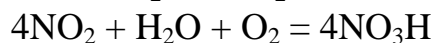
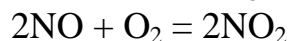
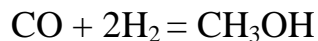
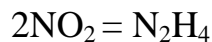

BALANCING IONIC EQUATIONS

These equations show reactions involving IONS (THESE ARE PARTICLES WHICH HAVE A + OR – CHARGE EITHER BY GAINING OR LOSING ELECTRONS). The size of the charge on an ion is the same as the combining power. Whether it is positive or negative depends on whether it is a metal or a non-metal. METALS HAVE POSITIVE ION AND NON-METALS HAVE NEGATIVE IONS.

In many ionic reactions, some ions DO NOT play any part in the reaction itself. We call these ions SPECTATOR IONS.

We can therefore write a very simple ionic equation using only the IMPORTANT IONS THAT REACT TOGETHER.

In these equations we always use STATE SYMBOLS. Aq means in water.

WORKED EXAMPLE OF AN IONIC EQUATION

Lead (II) nitrate + potassium iodide = lead(II) iodide and potassium nitrate

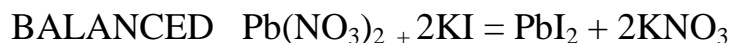
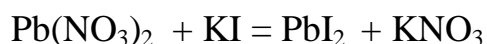

In the above reaction, the potassium ions and nitrate ions ARE SPECTATOR IONS and DO NOT actually take part in the chemical reaction.

The simplified ionic equation is:



The equation shows that any solution that contains lead (II) ions will react with any solution that contains iodide ions to form a new chemical compound called lead (II) iodide.

Similarly, any solution that contains copper (II) ions and any solution containing hydroxide ions will make a solid called copper (II) hydroxide.



IONIC HALF EQUATIONS

In a process called electrolysis (we will study it later), the reactions that take place at the **ELECTRODES** can be shown by **HALF EQUATIONS**.

Copper is a **POSITIVE METAL ION** that forms at a **NEGATIVE ELECTRODE** called the **CATHODE**.

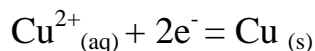

The symbol e^- stands for a **NEGATIVE ELECTRON**. At the negative cathode, positive ions **GAIN** electrons and become **NEUTRAL (NO CHARGE AT ALL)**. The equation **MUST BALANCE** in terms of symbols and charges.

A typical reaction at the **POSITIVE ANODE** would be **TWO** negative chloride ions **LOSING ELECTRONS** to form a **NEUTRAL** molecule of **CHLORINE GAS**.

This can be shown as:



In this reaction, two chloride ions combine to form one molecule of chlorine gas by losing two electrons.

ATOMIC MASSES AND THE CONCEPT OF THE MOLE

Atoms are far too light to be weighed. Instead, Scientists have developed a system called the RELATIVE ATOMIC MASS SCALE.

In this scale, the HYDROGEN ATOM was chosen as the unit that all other atoms are weighed relative to. This is because hydrogen is the LIGHTEST element in the periodic table.

On this scale, a carbon atoms HAS THE SAME MASS AS 12 HYDROGEN ATOMS. This is RELATIVE to the weight of one hydrogen atom.

We therefore say that carbon has a RELATIVE ATOMIC MASS OF 12.

Here are some other important relative atomic masses:

Hydrogen = 1
Carbon = 12
Nitrogen = 14
Oxygen = 16
Sodium = 23

This means that, for instance,
mass of one atom of oxygen = mass of 16 atoms of hydrogen etc

This means that the reference point has recently been changed to carbon and the DEFINITION of RELATIVE ATOMIC MASS IS

RELATIVE ATOMIC MASS IS THE MASS OF ONE ATOM ON A SCALE WHERE THE MASS OF A CARBON ATOM IS 12 UNITS.

This is an IMPORTANT DEFINITION FOR IGCSE and don't be too confused as to why the scale changed. You mainly need to USE the relative atomic masses instead of really understanding where the values all come from!

THE MOLE CONCEPT

MASS OF ATOMS

Just as one mole of carbon atoms has a mass of 12 g, so the mass of one mole of the atoms of any element is its "relative atomic mass" in grams.

For example,
look up the relative atomic mass of sodium (Na).

This is the number above it in the periodic table).

One mole of sodium has a mass of 23 g.

One mole of helium has a mass of 4 g,
One mole of neon has a mass of 20 g,
One mole of magnesium has a mass of 24 g,
One mole of calcium has a mass of 40 g.

This is easy for elements which exist as atoms.
What about elements which exist as molecules or compounds?

MASS OF COMPOUNDS

To find the mass of one mole of a compound, just add up all the RELATIVE ATOMIC MASSES of the elements of the compound, taking account of the formula.

The number you get is called the Relative Formula Mass.
It is the mass of one mole of the compound in grams.
The Relative Formula Mass can be written as M_r or RFM.

For example, the mass of one mole of carbon dioxide (CO_2) is
(1 x RAM of carbon) + (2 x RAM of oxygen)
 $= (1 \times 12) + (2 \times 16) = 44 \text{ g}$.

One mole of carbon dioxide has a mass of 44 g.
The Relative Formula Mass of carbon dioxide is 44.

We should really state that the Relative Molecular Mass (RMM) of carbon dioxide is 44 since carbon dioxide is a molecule.

The mass of one mole of calcium carbonate (CaCO_3) is
(1 x RAM of calcium) + (1 x RAM of carbon) + (3 x RAM of oxygen)
 $= (1 \times 40) + (1 \times 12) + (3 \times 16) = 100 \text{ g}$.

So, one mole of calcium carbonate has a mass of 100 g.

The Relative Formula Mass of calcium carbonate is 100.

If you are not sure what CaCO_3 stands for. It stands for and means 1 calcium + 1 carbon + 3 oxygens.

The mass of one mole of magnesium oxide (MgO) is
(1 x RAM of magnesium) + (1 x RAM of oxygen)
 $= (1 \times 24) + (1 \times 16) = 40 \text{ g}$.

So, one mole of magnesium oxide has a mass of 40 g.

The Relative Formula Mass of magnesium oxide is 40.

MOLES AND MOLECULES

One mole of hydrogen (H_2) molecules has a mass of 2 x the relative atomic mass (RAM) of hydrogen. This is because each molecule of hydrogen contains two atoms and the "relative atomic mass" is the relative mass of one atom. So, one mole of hydrogen molecules has a mass of 2 g (2 x 1). This is called the relative molecular mass (RMM).

One mole of nitrogen (N_2) molecules (RAM = 14) has a mass of 2 x 14 grams, = 28 g.

One mole of oxygen (O_2) molecules (RAM = 16) has a mass of 2 x 16 grams, = 32 g.

One mole of chlorine (Cl_2) molecules (RAM = 35.5) has a mass of 2 x 35.5 grams, = 71 g.

One mole of bromine (Br_2) molecules (RAM = 80) has a mass of 2 x 80 grams, = 160 g.

MASS OF PRODUCTS FROM REACTIONS – THE BASIC METHOD

For a chemical reaction, elements or compounds on the left side of the equation are called reactants, those on the right are called products.

reactants \rightarrow products.

Example 1.

What mass of magnesium oxide will be formed when 10 g of magnesium is burned in air?

1) Find how many moles of magnesium are present in 10 g of magnesium.

The RAM of magnesium is 24.

moles = mass \div RFM

moles = $10 \div 24 = 0.417$ moles of magnesium.

2) Write the equation for the reaction between magnesium and oxygen (burning in air means reacting with oxygen).

magnesium + oxygen \rightarrow magnesium oxide.

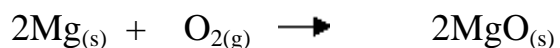

If you don't know why the formula for magnesium oxide is MgO, see Combining Power.

Look at the big numbers in front of the elements or compounds.

The big numbers tell you that 2 magnesiums will give 2 magnesium oxides.

This means that 2 moles of Mg give 2 moles of MgO, or one mole of Mg gives one mole of MgO.

The big numbers in the equation tell you that the proportion of Mg to MgO is one to one.

Since the proportion of Mg to MgO is 1 to 1, then 0.417 moles of magnesium will give 0.417 moles of magnesium oxide.

3) Find the mass of 0.417 moles of magnesium oxide.

The RFM of magnesium oxide is 40.

mass = moles x RFM

mass = 0.417 x 40 = 16.67 g of magnesium oxide.

This is the answer!

10 g of magnesium burnt in air will give 16.67 g of magnesium oxide (Phew!).

The next section will show an advanced method (a shortcut) to getting the same answer.

RULES FOR THE BASIC METHOD

- 1) Find the number of moles present in the reactant.
- 2) Write the equation for the reaction. Use the big numbers to find the proportion of reactant to product. The proportion will give you the number of moles of the product.
- 3) Find the mass of that number of moles of product.

MASS OF A PRODUCT FROM A REACTION – ADVANCED METHOD

From the previous section, the proportion of Mg to MgO is 1 to 1.

The one mole of Mg (RAM is 24) on the left of the equation has become one mole of MgO (RFM is 40) on the right of the equation.

24 g of Mg will make 40 g of MgO.

1 g of Mg will make $1 \times$ (the RFM of MgO divided by the RAM of Mg)
 $= 1 \times (40 \div 24)$
 $= 1.667$ g.

If 1 g of Mg makes 1.667 g of MgO, then 10 g of Mg makes 10×1.667 g of MgO, = 16.67 g.

Astonishing!

RULES FOR ADVANCED METHOD

- 1) Write the equation for the reaction.
Use the big numbers to find the proportion of reactant to product.
- 2) Divide the RFM of the product by the RFM of the reactant.
- 3) Multiply the number in 2 by both the proportion and the mass in grams of the reactant.

Here is an example for you to try using either the basic method or the advanced method. It is up to you which method you choose.

What mass of sodium oxide will be formed
by burning 20 g of sodium in air?

1) Find how many moles of sodium are present in 20 g of sodium.

The RAM of sodium is 23.

moles = mass \div RAM

moles = $20 \div 23 = 0.869$ moles of sodium.

2) Write the equation for the reaction.

sodium + oxygen \rightarrow sodium oxide.

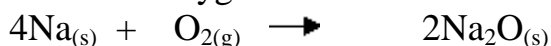

Use the big numbers to find the proportion of reactant to product.

4Na makes $2\text{Na}_2\text{O}$, so 2Na makes $1\text{Na}_2\text{O}$, so the proportion is 2 to 1.

0.869 moles of sodium will make $(0.869 \div 2)$ moles of sodium oxide,
= 0.435 moles of sodium oxide.

3) Find the mass of 0.435 moles of sodium oxide.

RFM of Na_2O is $(2 \times 23) + (1 \times 16) = 62$.

mass = moles \times RFM

mass = $0.435 \times 62 = 26.97$ g of sodium oxide.

So, burning 20 g of sodium in air will make 26.97 g of sodium oxide.

PERCENTAGE OF AN ELEMENT IN A COMPOUND

What is the percentage of Carbon in Propene?

Formula of propene is C_3H_6 . RAM of C = 12, RAM of H = 1.

Method.

The RFM of propene is $(3 \times 12) + (6 \times 1)$,

= $36 + 6$

= 42.36 of the 42 is due to carbon,

so the percentage of carbon in the compound is

$(36 \div 42) \times 100$

= 85.7%. Answer. Carbon makes up 85.7% of propene.

What is the percentage of Calcium in Calcium Carbonate?

The formula of calcium carbonate is CaCO_3 .

RAM of Ca = 40, RAM of C = 12, RAM of O = 16.

Method.

The RFM of calcium carbonate is $(1 \times 40) + (1 \times 12) + (3 \times 16)$,
 $= 40 + 12 + 48$
 $= 100$.

40 of the 100 is due to calcium,
so the percentage of calcium in the compound is
 $(40 \div 100) \times 100$
 $= 40\%$.

Answer. Calcium is 40% of calcium carbonate.

EMPIRICAL FORMULA FROM A REACTION

"Empirical" means "from experiment".

The empirical formula is the simplest proportion of elements in a compound.
The empirical formula is always the same
as the actual formula for ionic compounds.

For molecular compounds, the empirical formula is often (but not always)
the same as the molecular formula.

The molecular formula is the actual proportion
of elements in a molecular compound.

CO_2 , NH_3 , C_2H_4 , and C_3H_6 are examples of molecular formulae.

For an ionic compound, a reaction might show that the proportion of calcium to oxygen is 8 to 8. The empirical formula reduces the proportion to the lowest whole numbers (divide by 8).

So, the empirical formula is CaO , not Ca_8O_8 .

Similarly, a reaction might show that the proportion of sodium to carbon to oxygen is 6 to 3 to 9 (divide by 3).

The empirical formula is Na_2CO_3 , not $\text{Na}_6\text{C}_3\text{O}_9$.

For a molecular compound, a reaction might show that the proportion of carbon to hydrogen is 3 to 6 (divide by 3).

The empirical formula is CH_2 , not C_3H_6 .

CH_2 does not exist as a molecule.

The molecular formula could be any multiple of CH_2 ,

C_nH_{2n} where n is a whole number.

The molecule is an alkene, but to know which particular alkene it is, you must also know the relative molecular mass (RMM).

Here is an example

33.6 g of iron was found to react with 14.4 g of oxygen.

What is the empirical formula of iron oxide?

Method

1) Find how many moles of iron react with how many moles of oxygen.

RAM of Fe = 56, RAM of O = 16.

moles = mass \div RAM

for iron moles = $33.6 \div 56$
= 0.6 moles.

for oxygen moles = $14.4 \div 16$
= 0.9 moles.

2) The proportion of moles of iron to moles of oxygen is reduced to the lowest whole number.

0.6 moles of Fe to 0.9 moles of O.

Divide by 3, multiply by 10.

2 moles of Fe to 3 moles of O.

The empirical formula is Fe_2O_3 .

Since iron oxide is an ionic compound,

the actual formula is the same as the empirical formula. Try this one:

20g of calcium was found to react with 35.5 g of chlorine.

What is the empirical formula of calcium chloride?

Find how many moles of calcium react with how many moles of chlorine.

RAM of Ca = 40, RAM of Cl = 35.5.

moles = mass \div RAM

for calcium moles = $20 \div 40 = 0.5$ moles.

for chlorine moles = $35.5 \div 35.5 = 1.0$ moles.

2) The proportion of moles of calcium to moles of chlorine is reduced to the lowest whole number.

0.5 moles of Ca to 1.0 moles of Cl.

Multiply by 2.

1 mole of Ca to 2 moles of Cl.

The empirical formula is CaCl_2 .

Since calcium chloride is an ionic compound,
the actual formula is the same as the empirical formula.

MOLECULAR FORMULA FROM A COMPOUND

Example 1.

A compound was found to contain 3.0 g of carbon and 0.5 g of hydrogen.

The relative molecular mass of the compound is 42.

What is the molecular formula of the compound?

Method.

1) Find how many moles of carbon react with how many moles of hydrogen.

RAM of C = 12, RAM of H = 1.

moles = mass \div RAM

for carbon moles = $3 \div 12 = 0.25$ moles.

for hydrogen moles = $0.5 \div 1 = 0.5$ moles.

2) The proportion of moles of carbon to moles of hydrogen is reduced to the lowest whole number.

0.25 moles of C to 0.5 moles of H.

Multiply by 4.

1 mole of C to 2 moles of H.

The empirical formula is CH₂.

3) Divide the relative molecular mass of the compound by the relative molecular mass of the empirical formula.

RMM of the compound = 42.

RMM of the empirical formula = RMM of CH₂

= 12 + (2 x 1)

= 14.

42 ÷ 14 = 3.

There are 3 CH₂ units in the compound.

The molecular formula of the compound is C₃H₆.

The compound is propene.

Example 2.

A compound was found to contain 48 g of carbon and 12 g of hydrogen.

The relative molecular mass of the compound is 30.

What is the molecular formula of the compound?

Method.

1) Find how many moles of carbon react with how many moles of hydrogen.

RAM of C = 12, RAM of H = 1.

moles = mass ÷ RAM

for carbon moles = 48 ÷ 12 = 4.0 moles.

for hydrogen moles = 12 ÷ 1 = 12.0 moles.

2) The proportion of moles of carbon to moles of hydrogen is reduced to the lowest whole number.

4 moles of C to 12 moles of H.

Divide by 4.

1 mole of C to 3 moles of H.

The empirical formula is CH₃.

3) Divide the relative molecular mass of the compound by the relative molecular mass of the empirical formula.

RMM of the compound = 30.

RMM of the empirical formula = RMM of CH₃

= 12 + (3 x 1)

= 15.

30 ÷ 15 = 2.

There are 2 CH₃ units in the compound.

The molecular formula of the compound is C₂H₆.

The compound is ethane

CALCULATING VOLUMES OF GASES

Avogadro's Law says that the same volume of gas contains the same number of particles.

It does not matter what gas you have, they all contain the same number of particles provided that they are at the same temperature and pressure.

This leads on to an even more useful fact.

At room temperature (25 °C) and one atmosphere pressure (101kPa), one mole of any gas occupies a volume of 24,000 cm³ (24 litres).

The equation which converts moles into volume is

$$\text{volume} = \text{moles} \times 24,000 \text{ cm}^3$$

Example 1.

What volume of carbon dioxide is produced by burning 6 g of carbon in air?

Method.

1) Find how many moles of carbon are present in 6 g of carbon.
RAM of C = 12.

$$\text{moles} = \text{mass} \div \text{RAM}$$

$$\text{moles} = 6 \div 12 = 0.5 \text{ moles of carbon.}$$

2) Write the equation for the reaction.

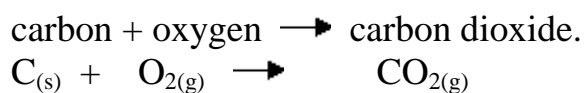

Use the big numbers to find the proportion of reactant to product.
1C gives 1CO₂, the proportion is 1 to 1,
so 0.5 moles of carbon will make 0.5 moles of carbon dioxide.

3) Convert moles into volume.

$$\text{volume} = \text{moles} \times 24,000 \text{ cm}^3$$

$$\text{volume} = 0.5 \times 24,000 \text{ cm}^3 = 12,000 \text{ cm}^3 \text{ of carbon dioxide.}$$

So, burning 6 g of carbon in air will produce 12,000 cm³ of carbon dioxide.

Example 2.

What volume of carbon dioxide is produced by burning 90 g of ethane in air?

1) Find how many moles of ethane are present in 90 g of ethane.
RAM of C = 12, RAM of H = 1.

$$\begin{aligned} \text{RMM of ethane (C}_2\text{H}_6) &= (2 \times 12) + (6 \times 1) \\ &= 30. \end{aligned}$$

$$\text{moles} = \text{mass} \div \text{RAM}$$

$$\text{moles} = 90 \div 30 = 3.0 \text{ moles of ethane.}$$

2) Write the equation for the reaction.

ethane + oxygen \rightarrow carbon dioxide + water.



Use the big numbers to find the proportion of reactant to product.

$2\text{C}_2\text{H}_6$ makes 4CO_2 , the proportion is 2 to 4, or 1 to 2,
so 3.0 moles of ethane will make 6.0 moles of carbon dioxide.

3) Convert moles into volume.

$$\text{volume} = \text{moles} \times 24,000 \text{ cm}^3$$

$$\text{volume} = 6.0 \times 24,000 \text{ cm}^3 = 144,000 \text{ cm}^3 \text{ of carbon dioxide.}$$

So, burning 90 g of ethane in air will produce $144,000 \text{ cm}^3$ of carbon dioxide.

Hydrogen is produced in the laboratory by adding zinc to dilute sulphuric acid.

Example 3.

What volume of hydrogen is produced
by reacting 6.5 g of zinc with dilute sulphuric acid?

Method.

1) Find how many moles of zinc are present in 6.5 g of zinc.

RAM of Zn = 65.

$$\text{moles} = \text{mass} \div \text{RAM}$$

$$\text{moles} = 6.5 \div 65 = 0.1 \text{ moles of zinc.}$$

2) Write the equation for the reaction.

zinc + sulphuric acid \rightarrow zinc sulphate + hydrogen.



Use the big numbers to find the proportion of reactant to product.

1Zn makes 1H_2 , the proportion is 1 to 1,
so 0.1 moles of zinc will make 0.1 moles of hydrogen.

3) Convert moles into volume.

$$\text{volume} = \text{moles} \times 24,000 \text{ cm}^3$$

$$\text{volume} = 0.1 \times 24,000 \text{ cm}^3 = 2,400 \text{ cm}^3 \text{ of hydrogen.}$$

So, reacting 6.5 g of zinc with dilute sulphuric acid will produce 2,400 cm³ of hydrogen.

A reaction was found to produce two litres of Chlorine.
What is the mass of 2 litres of chlorine?

Method.

1) Find how many moles of chlorine are present in 2 litres.

One mole of any gas occupies a volume of 24,000 cm³ (24 litres).
1 litre = 1,000 cm³, 2 litres = 2,000 cm³.

The equation which converts volume into moles is

$$\text{moles} = \text{volume (in cm}^3) \div 24,000$$

$$\text{moles} = 2,000 \div 24,000 = 0.083 \text{ moles of chlorine.}$$

2) What is the mass of 0.083 moles of chlorine?

One mole of chlorine gas contains one mole of chlorine molecules.
Each chlorine molecule contains two chlorine atoms,
so use the relative molecular mass. RMM of Cl₂ = 71.

$$\text{mass} = \text{moles} \times \text{RFM}$$

$$\text{mass} = 0.083 \times 71 = 5.89 \text{ g of chlorine.}$$

So, 2 litres of chlorine has a mass of 5.89 g.

CALCULATING MASSES OR VOLUMES FROM ELECTROLYSIS

Example 1.

The electrolysis of molten sodium chloride produces sodium at the cathode and chlorine at the anode.

What mass and volume of chlorine is obtained if 46 g of sodium are deposited at the cathode?

Method.

1) Find how many moles of sodium are present in 46 g of sodium.

RAM of Na = 23.

moles = mass \div RAM

moles = $46 \div 23 = 2$ moles of sodium.

2) Write the half equations for the electrolysis.

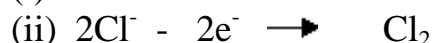
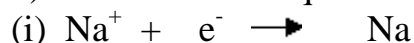

Balance the half equations, to give the same number of electrons on each side.

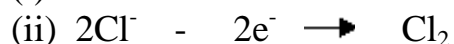
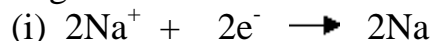

Find the proportion of how many moles of product are discharged at each electrode.

2 moles of Na at the cathode give 1 mole of Cl_2 at the anode.

3) Find the mass and volume of 1 mole of chlorine.

The mass of 1 mole of Cl_2 is 71 g.

The volume of 1 mole of Cl_2 is $24,000 \text{ cm}^3$ (see previous page).

Example 2.

The electrolysis of sodium chloride dissolved in water produces hydrogen at the cathode and chlorine at the anode.

What mass and volume of hydrogen is obtained if 142 g of chlorine are discharged at the anode?

Method.

1) Find how many moles of chlorine are discharged at the anode.

RMM of $\text{Cl}_2 = 71$.

$\text{moles} = \text{mass} \div \text{RMM}$

$\text{moles} = 142 \div 71 = 2$ moles of chlorine.

2) Write the half equations for the electrolysis.

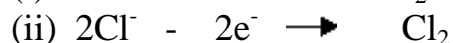
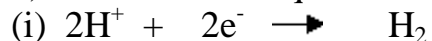

Balance the half equations, to give the same number of electrons on each side. (the equations are already balanced).

Find the proportion of how many moles of product are discharged at each electrode.

1 mole of H_2 at the cathode gives 1 mole of Cl_2 at the anode.

The proportion is 1 to 1.

2 moles of Cl_2 gives 2 moles of H_2 .

3) Find the mass and volume of 2 moles of hydrogen.

The RMM of hydrogen is 2.

mass = moles x RMM

$\text{mass} = 2 \times 2 = 4$ grams of hydrogen.

volume = moles x 24,000 cm^3

$\text{volume} = 2 \times 24,000 \text{ cm}^3 = 48,000 \text{ cm}^3$ of hydrogen.

This occupies the same volume as 142 g of Cl₂.

A unit of electrical charge is called a Coulomb.

One Coulomb (symbol Q) is 6.2×10^{18} electrons.

One mole of electrons is the same as 96,500 Coulombs.

96,500 Coulombs is called a Faraday.

Electric current (symbol I) is a flow of electrical charge.

The rate of flow of electrical charge is measured in amps (A).

One amp is one Coulomb per second. $Q = I \times t$.

Example 3.

The electrolysis of molten lead bromide - PbBr₂

produces lead at the cathode and bromine at the anode.

A current of 10 amps is allowed to flow through molten lead bromide for 5 hours.

What mass of lead is deposited at the cathode?

Method.

1) Write the half equation for the electrolysis.

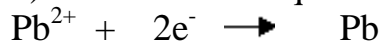

2 moles of electrons (2 Faradays) are required to deposit 1 mole of lead.

2) Find how many Faradays have passed through the lead bromide in 5 hours.

$$Q = I \times t$$

5 hours contains (5 x 60 x 60) seconds

= 18,000 seconds.

$$Q = 10 \times 18,000$$

$$= 180,000 \text{ Coulombs.}$$

1 Faraday = 96,500 coulombs.

180,000 coulombs = $180,000 \div 96,500$ Faradays

= 1.865 Faradays.

- 3) From the proportion in 1, 2 Faradays are required to deposit 1 mole of lead.
1.865 faradays will deposit $(1.865 \div 2)$ moles of lead,
= 0.933 moles of lead.

$$\text{mass} = \text{moles} \times \text{RAM}$$

$$\text{RAM of lead} = 207$$

$$\text{mass} = 0.933 \times 207 = 193 \text{ g of lead.}$$

Example 4.

The electrolysis of molten aluminium oxide - Al_2O_3 produces aluminium at the cathode and oxygen at the anode.
See the [extraction of aluminium](#) for more detail.

A current of 10 amps is allowed to flow through molten aluminium oxide for 5 hours.
What mass of aluminium is deposited at the cathode?

Method.

1) Write the half equation for the electrolysis.

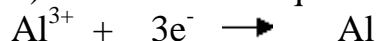

3 moles of electrons (3 Faradays) are required to deposit 1 mole of aluminium.

2) Find how many Faradays have passed through the aluminium oxide in 5 hours.

$$\text{Q} = \text{I} \times \text{t}$$

$$\begin{aligned} 5 \text{ hours contains } (5 \times 60 \times 60) \text{ seconds} \\ = 18,000 \text{ seconds.} \end{aligned}$$

$$\begin{aligned} \text{Q} &= 10 \times 18,000 \\ &= 180,000 \text{ Coulombs.} \end{aligned}$$

$$\begin{aligned} 1 \text{ Faraday} &= 96,500 \text{ coulombs.} \\ 180,000 \text{ coulombs} &= 180,000 \div 96,500 \text{ Faradays} \\ &= 1.865 \text{ Faradays.} \end{aligned}$$

3) From the proportion in 1
3 Faradays are required to deposit 1 mole of aluminium.
1.865 Faradays will deposit $(1.865 \div 3)$ moles of aluminium
= 0.622 moles of aluminium.

mass = moles x RAM

RAM of aluminium = 27

mass = $0.622 \times 27 = 16.79$ g of aluminium.

Compare this figure with 193 g of lead, 11.5 times the mass from the same quantity of electricity (see the previous page).
The high charge on the aluminium ion (Al^{3+}) requiring 3 Faradays per mole makes aluminium expensive to extract.
In addition, aluminium has a light nucleus (RAM = 27).
One mole of aluminium has a mass of only 27 g.
One mole of lead has a mass of 207 g.

CALCULATING THE CONCENTRATION OF SOLUTIONS

A concentrated solution will have a large number of particles of the solute in the solvent.

A dilute solution will have a small number of particles of the solute in the solvent.

Concentrations can be expressed as the number of moles in a particular volume or the number of grams in a particular volume.

Moles per cubic decimetre or mol/dm^3 or mol dm^{-3} all mean the same thing.
A cubic decimetre is the same as a litre.

Grams per dm^3 or grams/dm^3 or grams dm^{-3} all mean the same thing.

The number of moles of solute in solution is given by the formula

$$\text{moles} = (\text{C} \times \text{V}) \div 1000$$

where C = concentration in mol dm^{-3} (moles per dm^3).
V = volume in cm^3 .

PERFORMING A TITRATION TO FIND THE VOLUME OR CONCENTRATION OF A SOLUTION

This is a complicated technique and is shown in stages below:

A titration is a method of analysis that will allow you to determine the precise endpoint of a reaction and therefore the precise quantity of reactant in the titration flask. A buret is used to deliver the second reactant to the flask and an indicator or pH Meter is used to detect the endpoint of the reaction.

STEP 1



Begin by preparing your burette. Your burette should be conditioned and filled with titrant (liquid in the burette) solution. You should check for air bubbles and leaks, before proceeding with the titration.

STEP 2

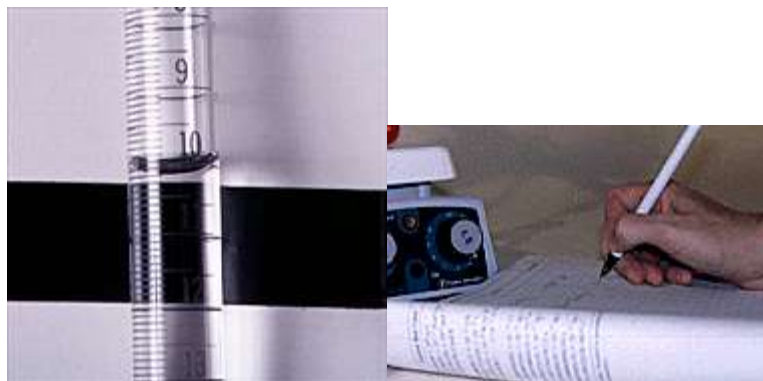

Take an initial volume reading and record it in your notebook. Before beginning a titration, you should always calculate the expected endpoint volume

STEP 3



Prepare the solution to be analyzed by placing it in a clean conical flask or beaker

STEP 4



Use the burette to deliver a stream of titrant to within a couple of mL of your expected endpoint. You will see the indicator change color when the titrant hits the solution in the flask, but the color change disappears upon stirring.

STEP 5



Approach the endpoint more slowly and watch the color of your flask carefully. Use a wash bottle to rinse the sides of the flask and the tip of the buret, to be sure all titrant is mixed in the flask.

STEP 6



As you approach the endpoint, you may need to add a partial drop of titrant. You can do this with a rapid spin of a teflon stopcock or by partially opening the stopcock and rinsing the partial drop into the flask with a wash bottle. Ask your Teacher to demonstrate these techniques for you, in the lab.

STEP 7



Make sure you know what the endpoint should look like. For phenolphthalein, the endpoint is the first permanent pale pink. The pale pink fades in 10 to 20 minutes.

If you think you *might* have reached the endpoint, you can record the volume reading and add another partial drop. Sometimes it is easier to tell when you have gone past the endpoint.

STEP 8



If the flask looks like this, you have gone too far!

STEP 9



When you have reached the endpoint, read the final volume in the buret and record it in your notebook.

STEP 10 – THE FINAL STEP



Subtract the initial volume to determine the amount of titrant delivered. Use this, the concentration of the titrant, and the stoichiometry of the titration reaction to calculate the number of moles of reactant in your analyte solution.

HERE ARE SOME WORKED EXAMPLES!

Example 1.

In a titration, 50 cm³ of 2 mol dm⁻³ sodium hydroxide was exactly neutralised by 30 cm³ of hydrochloric acid.

What is the concentration of the hydrochloric acid?

Method.

1) Write the equation for the reaction.

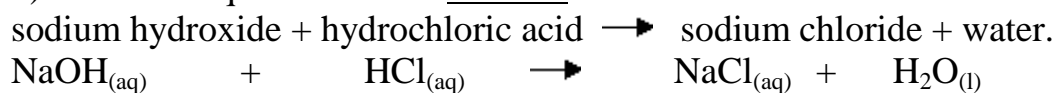

Use the big numbers to find the proportion of NaOH to HCl.

One mole of NaOH reacts with one mole of HCl.

2) Find how many moles of sodium hydroxide are present.

$$\text{moles} = (\text{C} \times \text{V}) \div 1000.$$

The number of moles in 50 cm³ of 2 mol dm⁻³ sodium hydroxide = (2 x 50) ÷ 1000 = 0.1 moles of sodium hydroxide.

3) From 1 and 2, 30 cm³ of hydrochloric acid also contains 0.1 moles.

You can rearrange $\text{moles} = (C \times V) \div 1000$ to give

$$C = (\text{moles} \times 1000)$$

$$C = (0.1 \times 1000) \div 30 \\ = 3.33.$$

The concentration of hydrochloric acid is 3.33 mol dm⁻³.

Example 2.

In a titration, 20 cm³ of 0.5 mol dm⁻³ sodium hydroxide is exactly neutralised by 40 cm³ of sulphuric acid.

What is the concentration of the sulphuric acid?

Method.

1) Write the equation for the reaction.

sodium hydroxide + sulphuric acid \longrightarrow sodium sulphate + water.

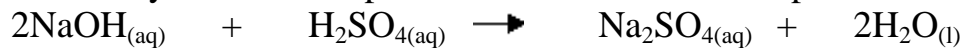

Use the big numbers to find the proportion of NaOH to H₂SO₄.

Two moles of NaOH react with one mole of H₂SO₄.

2) Find how many moles of sodium hydroxide are present.

$$\text{moles} = (C \times V) \div 1000.$$

The number of moles in 20 cm³ of 0.5 mol dm⁻³ sodium hydroxide

$$= (0.5 \times 20) \div 1000$$

$$= 0.01 \text{ moles of NaOH.}$$

3) From 1, the proportion of NaOH to H₂SO₄ is 2 to 1.

0.01 moles of NaOH react with (0.01 \div 2) moles of H₂SO₄

$$= 0.005 \text{ moles H}_2\text{SO}_4.$$

So, there are 0.005 moles of H₂SO₄ in 40 cm³.

$$C = (\text{moles} \times 1000) = (0.005 \times 1000) \div 40$$

$$= 0.125. \text{ The concentration of sulphuric acid is } 0.125 \text{ mol dm}^{-3}.$$

TOPIC 5 – ELECTRICITY AND CHEMISTRY

Many chemical reactions involve energy changes where heat or light may be produced. Sometimes, it is possible in chemistry to convert this energy and turn it into an ELECTRIC CURRENT.

A CELL turns chemical energy into electrical energy. A simple cell was invented by a Chemist called Daniell to use the reaction between Zinc metal and copper (II) sulphate solution to provide electrical energy.

When this reaction is carried out, a DISPLACEMENT reaction happens and heat is produced.

Here is a diagram of the Daniell Cell:

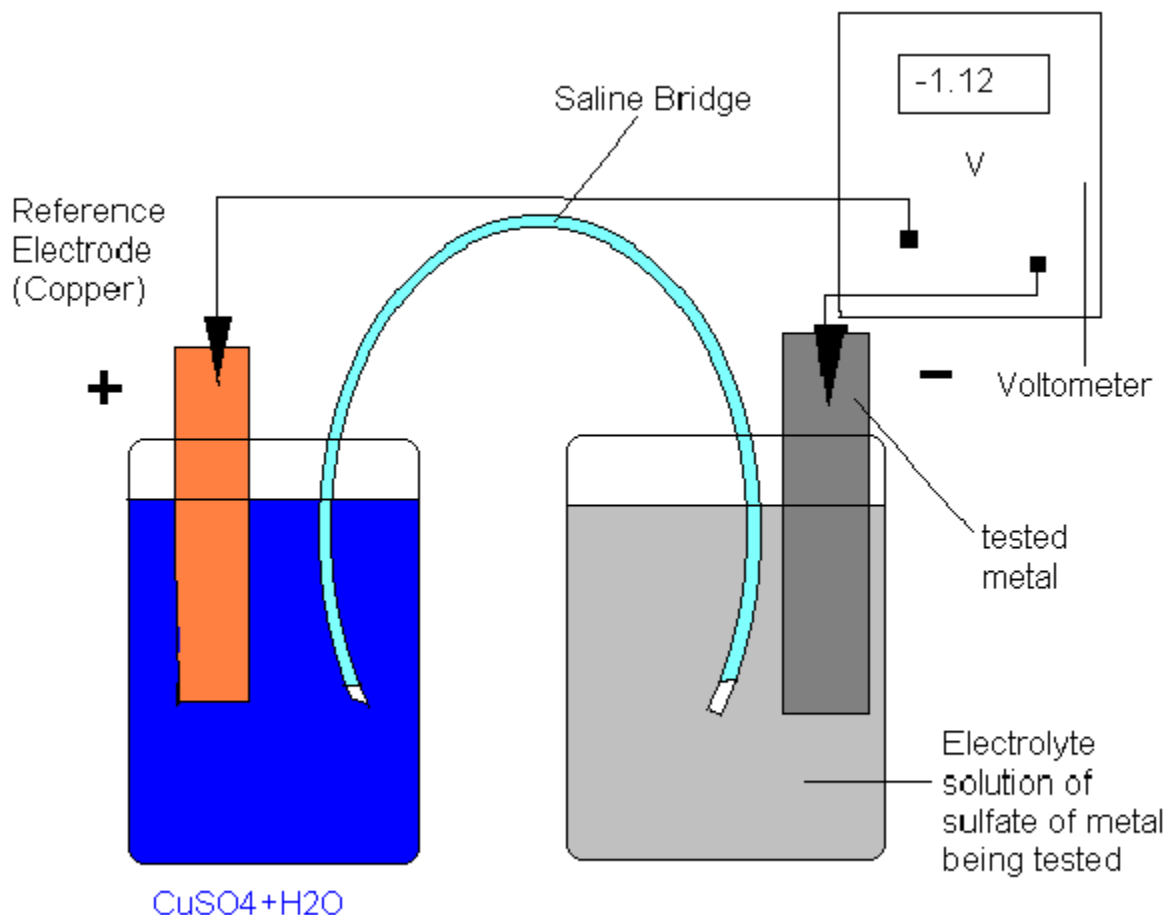



Each zinc atom gives away 2 electrons to a Cu^{2+} ion.

Zinc has a bigger chance of giving away electrons than copper. This means that zinc is a better reducing agent. Copper ions are reduced to copper metal (by accepting electrons) and Zinc metal is oxidized into Zn^{2+} (by losing electrons).

In the Daniell cell, when copper and zinc are used as electrodes and the two solutions are 1 mol/dm^3 , a potential difference of approximately + 1.1 V is set up.

Other pairs of metals can be used to make similar cells. The more reactive metal in the pair of metals used will **LOSE ELECTRONS** to the ions of the less reactive metal. When the metals are **VERY CLOSE TO EACH OTHER** in the reactivity series, the potential difference that results is very small.

LARGE POTENTIAL DIFFERENCE – BIG DIFFERENCE IN REACTIVITY

SMALL POTENTIAL DIFFERENCE – SMALL DIFFERENCE IN REACTIVITY

For example, a cell which uses iron and zinc – which have similar reactivities – will set up a potential difference of only +0.32 Volts.

But, a cell that involves magnesium and silver with **HIGH** differences in reactivity (magnesium is a reactive metal, silver is not) sets up quite a large potential difference of +3.2 Volts.

HOW ARE CELLS USED?

THE LEAD/ACID BATTERY

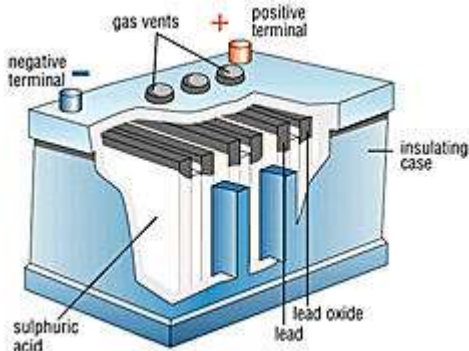

A battery is a series of individual cells that are combined together.

The battery that provides electrical energy for vehicles is known as a **LEAD-ACID ACCUMULATOR**. When the vehicle is started, the battery provides an electric current that is used to start the engine. Once the engine is running, it drives a small dynamo that makes an electric current that is used to **RECHARGE** the battery. The battery is made from a series of lead plates **ALTERNATING** with a grid of lead packed with lead (IV) oxide PbO_2 . The plates dip into a solution of sulphuric acid which provides the electrical energy.

Lead/acid batteries are very heavy because lead is **A DENSE METAL**. One of the problems with electrically powered vehicles is that the batteries have a **HUGE MASS**. However, electric vehicles are very quiet and very efficient and environmentally friendly as they do not provide and harmful gases to the environment and do not make much noise.

Lead and its compounds are poisonous however. Used batteries do not cause pollution problems as lead is a valuable metal. Most lead that is in an old battery is recycled and made into a new battery again. It is illegal to throw away an old lead/acid battery and not send it for recycling.

ZINC CARBON DRY CELLS

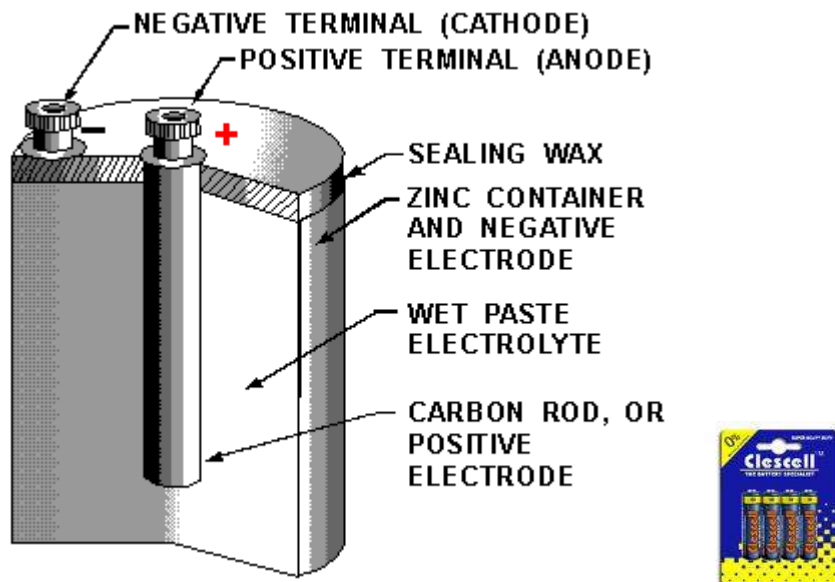

Everyday batteries that we use in a torch, calculator, walkman or i-pod ARE ZINC-CARBON DRY CELL BATTERIES. The electrolyte in a dry cell is usually made of a substance called AMMONIUM CHLORIDE PASTE and is kept slightly damp or MOIST so that there is no risk of leaks or spills. The zinc casing of the battery acts as the NEGATIVE CATHODE and is gradually WORN AWAY. When the battery is flat (no power left) the zinc cathode has been used up and totally worn away. It is important to remember to remove the battery from the electrical equipment at that time as the wet paste may leak out and cause damage that may permanently stop the device from working. Once the battery has gone flat, it must be thrown away.

SILVER OXIDE CELLS



The tiny cells that look like a button in watches, calculators or cameras are also a type of dry cell. They contain silver metal and zinc oxide. Silver is expensive and so is the cost of these cells. They last for a long time because the watches and batteries only run on a very small electrical current.

ALKALINE CELLS

Alkaline cells are very similar to zinc-carbon dry batteries but the electrode contains ALKALI called potassium hydroxide. The zinc electrode has holes in it that makes it SLIGHTLY POROUS a bit like a sponge. Alkaline cells provide a larger electric current and last longer than zinc-carbon dry cells.

RECHARGEABLE CELLS

One type of rechargeable cell contains NICKEL AND CADMIUM compounds. A redox reaction takes place when the cell is being used. When the cell is placed into a recharger, an electric current passes through it. This REVERSES THE REACTION and RECHARGES the cell.

FUEL CELLS

These use the energy from fuels to provide electrical energy. A fuel like hydrogen or methane is passed into the cell along with a stream of oxygen gas. These are made to react via the external circuit to provide the electric current. Fuel cells are expensive to make but provided that the fuel is continuously passed in, the cell will continue to provide an electric current. Fuel cells are used in NASA spacecraft to provide a constant source of electrical energy.

THE ELECTROLYSIS OF MOLTEN LEAD (II) BROMIDE

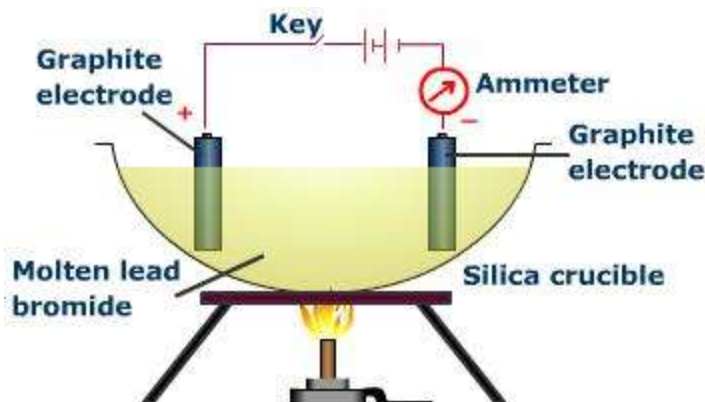

Lead (II) bromide PbBr_2 is made from lead ions Pb^{2+} and 2 bromide ions Br^- .

When the compound is molten (hot and runny), the ions are free to move and drift towards the oppositely charged electrode where the ions are turned into either atoms or molecules.

The equations for the electrolysis are:

NEGATIVE CATHODE: $\text{Pb}^{2+} + 2\text{e}^- = \text{Pb metal}$

POSITIVE ANODE: $2\text{Br}^- = \text{Br}_2 + 2\text{e}^-$

THE ELECTROLYSIS OF CONCENTRATED HYDROCHLORIC ACID

Hydrochloric acid is a strong acid and ionizes like so



These ions drift to the oppositely charged electrode and get turned into molecules

The equations for the electrolysis are:

NEGATIVE CATHODE $2\text{H}^+ + 2\text{e}^- = \text{H}_2$

POSITIVE ANODE $2\text{Cl}^- = \text{Cl}_2 + 2\text{e}^-$

DOES THE ELECTRODE MATERIAL AFFECT THE OUTCOME OF ELECTROLYSIS?

YES!

Let us consider the electrolysis of copper(II) sulphate solution using carbon electrodes:

AT THE ANODE

Sulphate ions are NOT MADE. Hydroxide ions from the water are attracted to the positive anode and turned into OXYGEN GAS

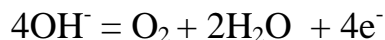

AT THE CATHODE

Copper metal forms. The discharge of the hydroxide ions involves 4 electrons. To balance these electrons, 2 copper (II) ions must be discharged.

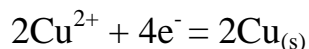

BUT WHEN WE USE COPPER ELECTRODES!!!

A different process happens.

At the positive anode, copper on the anode dissolves away and becomes dissolved in the copper (II) sulphate solution.

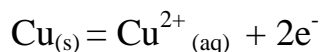

At the cathode, newly formed copper metal is deposited there

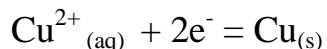

THE ELECTROLYSIS OF CONCENTRATED AQUEOUS SODIUM CHLORIDE (BRINE)

You need to know the **products** formed by the **electrolysis** of concentrated sodium chloride solution, and simple laboratory tests for them.

The electrolysis of brine

Brine is concentrated sodium chloride solution. If an electric current is passed through it, hydrogen gas forms at the negative **electrode** and chlorine gas forms at the positive electrode. A solution of sodium hydroxide forms. These three products have important uses in industry.

You might have expected sodium metal to be deposited at the negative electrode. But sodium is too reactive for this to happen, so hydrogen is given off instead.

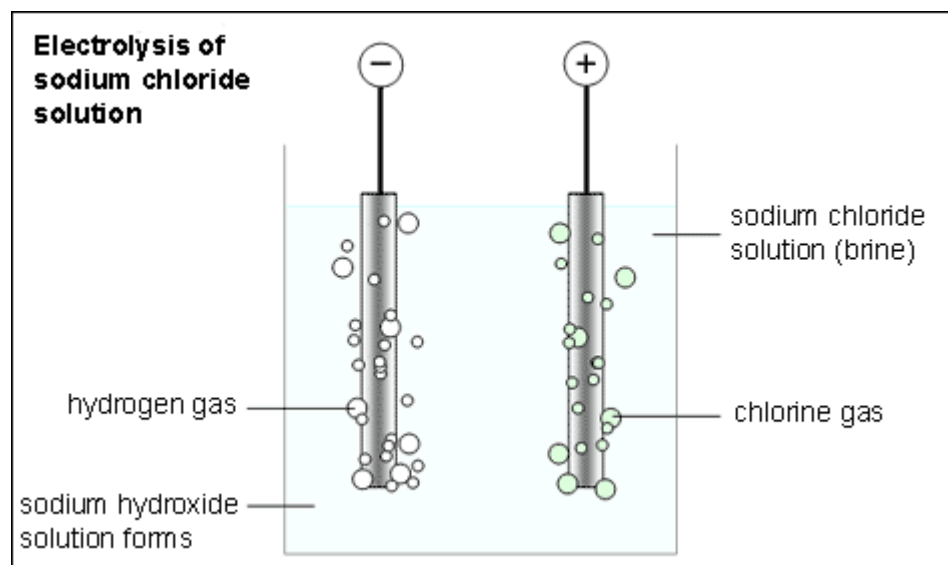

Laboratory tests

The table shows the common laboratory tests for the products from the electrolysis of brine.

Substance	Test and result
hydrogen gas	a lighted splint pops
chlorine gas	damp litmus paper is bleached white
sodium hydroxide solution	universal indicator solution turns purple

When sodium chloride dissolves in water, the ions become separated:

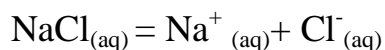

Also present are some ions from the water

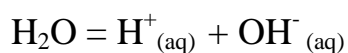

In the process of electrolysis, ions are changed into atoms. With brine:

Na^+ and H^+ are attracted to the negative cathode and

Cl^- and OH^- are attracted to the positive anode

AT THE CATHODE (-)

Sodium is more reactive than hydrogen, so only the HYDROGEN IONS are changed to atoms. This forms a molecule of hydrogen gas.

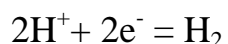

AT THE ANODE (+)

Both OH^- and Cl^- are attracted to the anode, but only the CHLORIDE IONS are changed to atoms. This forms a molecule of chlorine gas.

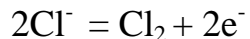

The ions that are left in solution are Na^+ and OH^- . These ions combine together to form a solution of sodium hydroxide alkali $\text{NaOH}_{(\text{aq})}$.

The electrolysis of brine is an **EXTREMELY IMPORTANT INDUSTRIAL PROCESS** and is the basis of what we call the **CHLOR-ALKALI** industry.

It is called this as we make huge amounts of CHLORine gas and Sodium hydroxide **ALKALI** solution.

CONDITIONS FOR ELECTROLYSIS

The substance that has electrolysis done on it is called the ELECTROLYTE.

The electrolyte must contain IONS that are FREE TO MOVE ABOUT.

In other words, the electrolyte must be MOLTEN (hot and runny) or in SOLUTION. A direct current (d.c.) voltage must be used.

The ELECTRODE connected to the POSITIVE terminal of the power supply is the ANODE. The electrode connected to the negative terminal is called the CATHODE. The electrical circuit can be drawn. It is called an ELECTROLYSIS CELL.

HOW DOES THE ELECTROLYTE CHANGE?

The negative ions are attracted to the anode. They release electrons. Loss of electrons is called oxidation.

For example, chloride ions become chlorine molecules + electrons



The positive ions are attracted to the cathode and gain electrons. Gaining electrons is called reduction.

For example, copper ions get electrons and become copper atoms

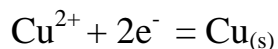

The electrons move through the external circuit from the anode to the cathode.

THE ELECTROLYSIS OF WATER

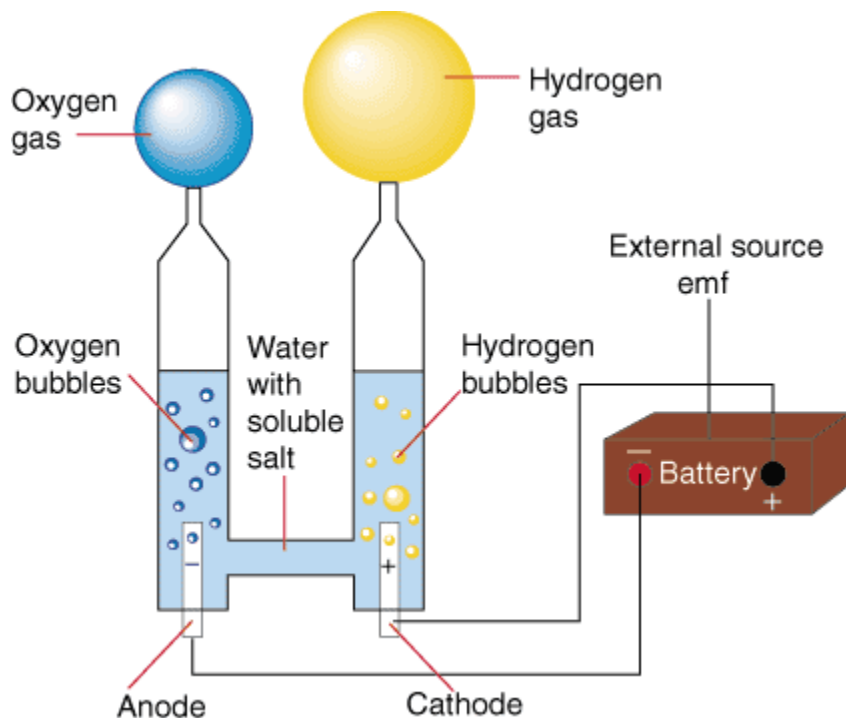

This takes place in the special apparatus above known as a HOFFMAN VOLTAMETER.

At the anode:

Hydroxide ions from the water are attracted and become oxygen gas:

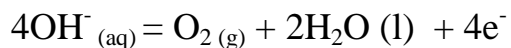

At the cathode:

Four hydrogen ions pick up these 4 electrons to form TWO molecules of hydrogen gas

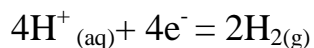

USING ELECTROLYSIS – THE EXTRACTION OF ALUMINIUM FROM BAUXITE

This is another very important industrial process

We use the following electrolysis cell

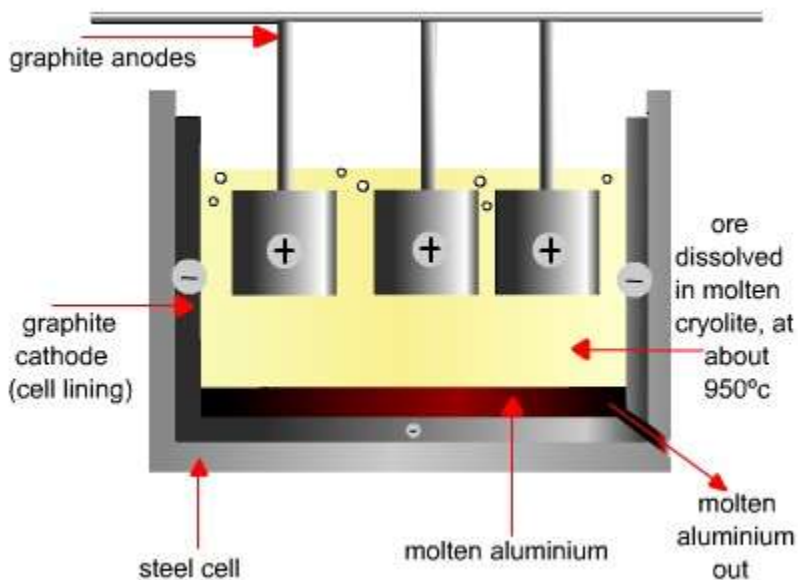

Aluminium is extracted from the ore BAUXITE or aluminium oxide Al_2O_3 .

The aluminium oxide is **INSOLUBLE** so it is **MELTED** to allow the ions to move when the electric current is passed through it. Remember that electrolysis can only take place when the ions are **MOLTEN** or **IN SOLUTION**.

The anodes are made from **CARBON** and the cathode is a carbon-lined **STEEL CASE**.

At the cathode, aluminum metal forms



At the anode, oxygen is formed

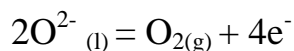

The oxygen reacts with the carbon anodes and makes CO₂ gas. Anodes have to be replaced periodically.

ADDITIONAL NOTES FOR A* STUDENTS

The aluminium ions are reduced by the addition of electrons to form aluminium atoms. The oxide ions are oxidized as they lose electrons to form oxygen molecules. This process often uses massive amounts of electricity and needs economical low-price electricity. Aluminium is often extracted in countries which have an abundance of hydro-electric power.

THE PURIFICATION OF COPPER BY ELECTROLYSIS

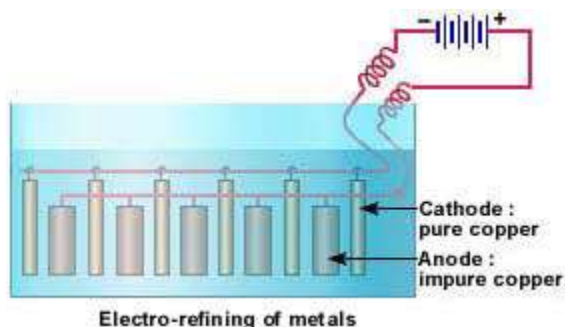

Copper is extracted from its ore (usually malachite) by reduction with carbon (like iron ore is during the blast furnace) but the copper that is made is not pure enough for some of its uses – such as electrical wiring and cables. It can be purified by using electrolysis. The cell used (shown above) has an anode of impure copper. Copper (II) SULPHATE SOLUTION IS USED AS THE ELECTROLYTE. The cathode is made from a THIN PIECE OF PURE COPPER.

At the positive anode, copper atoms dissolve forming copper ions

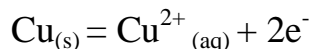

At the negative cathode, copper ions are deposited on the copper which refines and purifies it

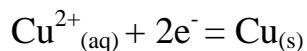

PREDICTING THE PRODUCTS OF ELECTROLYSIS

Substances which can allow electrolysis to take place are made from ions. The ions need to be able to move (molten or in solution).

SOLID ELECTROLYTES DO NOT CONDUCT ELECTRICITY (NO FREE IONS)

MOLTEN IONIC SOLUTIONS MAKE TWO IONS WHICH GO TO THE OPPOSITELY CHARGED ELECTRODE

Some examples of this are shown below:

MOLTEN IONIC COMPOUND	IONS	CATHODE (-)	ANODE (+)
SODIUM CHLORIDE NaCl	$\text{Na}^+ \text{Cl}^-$	2Na	Cl_2
COPPER (II) BROMIDE CuBr_2	$\text{Cu}^{2+} \text{Br}^-$	Cu	Br_2
ZINC IODIDE ZnI_2	$\text{Zn}^{2+} \text{I}^-$	Zn	I_2

Aqueous solutions are much more complicated as they contain the ions from the compound and also the ions from the water.

For example, sodium chloride solution



Both positive ions will go to the negative cathode but only the H^+ ion is discharged as H_2 .

Both negative ions go to the positive anode but only the Cl^- is discharged as Cl_2 .

GENERAL RULE IN ELECTROLYSIS

CATHODE (-) METALS AND HYDROGEN DISCHARGED

ANODE (+) NON-METALS DISCHARGED

THE CHLOR-ALKALI INDUSTRY IN MORE DETAIL

The large scale (industrial) manufacture of chlorine gas, hydrogen gas and sodium hydroxide by the electrolysis of brine involves collecting the 3 substances and making sure that THEY DO NOT MIX TOGETHER when they are being produced in the electrolysis cell.

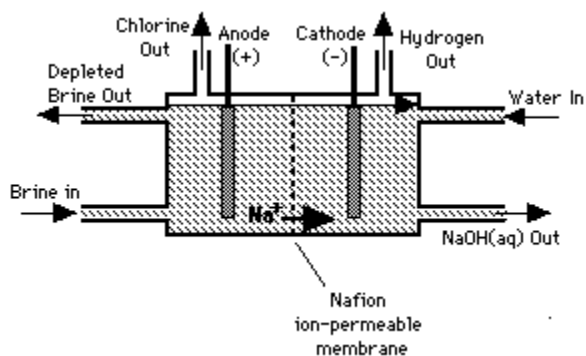

The above cell is called a MEMBRANE CELL.

The old system was called a MERCURY CATHODE CELL but obviously having a cathode made from mercury was both expensive and potentially dangerous (mercury is poisonous and disposal of it is a health problem) so a cell like the one above called a MEMBRANE CELL is now used.

Both processes are VERY EFFICIENT since there is actually little waste produced. The unused brine and mercury are actually recycled. THE MAJOR COST IS THE AMOUNT OF ELECTRICITY that is used to run the process.

The major difference between the two cells is that the membrane cell produces 3 substances from the cell but the mercury cell extracts the sodium as an AMALGAM.

AN AMALGAM IS A SOLID METAL (SODIUM) SUSPENDED IN A LIQUID METAL (MERCURY)

The sodium/mercury amalgam is then reacted with water

Sodium metal + water = sodium hydroxide + hydrogen gas

This means the mercury cell is a more INDIRECT method than the membrane cell.

USES OF THE PRODUCTS OF THE CHLOR-ALKALI INDUSTRY

CHLORINE

Killing bacteria in water, making bleaches, paints, dyes, hydrochloric acid, drugs and pharmaceuticals

HYDROGEN

Making nylon, margarine, hydrogen peroxide (hair bleach), ammonia

SODIUM HYDROXIDE

This is used for purifying natural gas, sewage treatment, degreasing materials (oven cleaner), making paper, soaps and detergents.

The chlor-alkali process is also responsible for the following important reactions.

Manufacturing Sodium Chlorate

Sodium hydroxide and chlorine are mixed at room temperature to form sodium chlorate.



Uses of the Industrial Products

Sodium

- Manufacture of titanium:

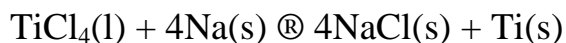

Sodium Hydroxide

- Manufacture of soap

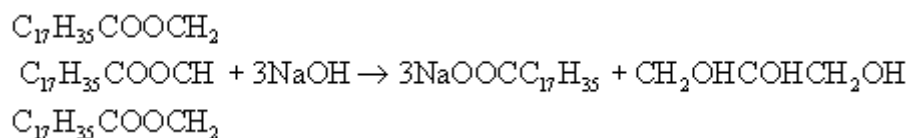

Triglyceride + sodium hydroxide ® sodium stearate + glycerol

Hydrogen

- Manufacture of Ammonia in the Haber Process

Chlorine

- Manufacture of solvents (e.g. CCl₄).

Sodium Chlorate

- NaOCl is used in domestic bleach. The NaCl impurity is usually left in the bleach as it is not important unless an acid is added, in which case the two react together to form chlorine (the solution proportionates).

THE ELECTROPLATING OF METALS

Metals that get coated with a layer of another metal using electricity are said to have been **ELECTROPLATED**.

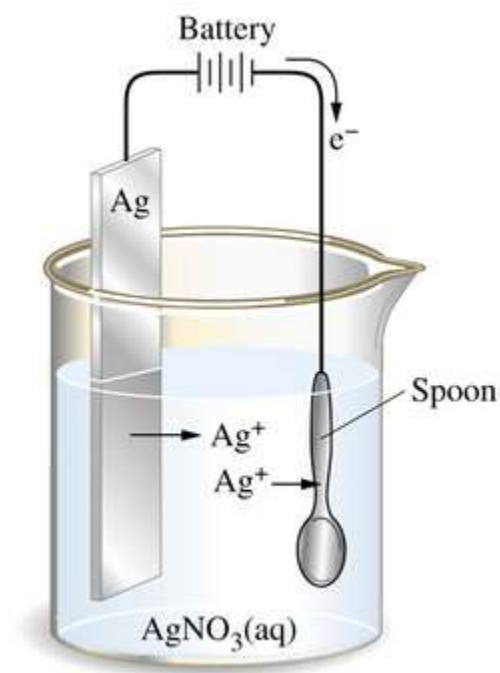

Silver plating is probably the most common example of electroplating.

Here we can see a steel spoon being electroplated with silver to make it look more expensive and attractive.

The object that you wish to electroplate is **ALWAYS THE CATHODE**. This is to attract the positive silver ions that are in the electrolyte which is a solution of silver nitrate. The anode is **ALWAYS MADE OF THE PURE METAL THAT YOU WANT TO ELECTROPLATE WITH**.

The silver dissolves as the electroplating takes place as the silver drifts towards the spoon.

CONDUCTORS AND INSULATORS OF ELECTRICITY

Materials can be classified in 3 ways

Metals and non-metals, ceramics and glasses or plastics.

METALS AND NON-METALS

Here is a table to show the property differences between metals and non-metals

METALS	NON-METALS
Usually have high melting and boiling point	Most have low melting points and boiling points
Have a shiny surface	Have a dull surface
Can be hammered into shape (malleable) or stretched into wires (ductile)	Are brittle when solid and break/snap easily
Mostly solids (except mercury and cadmium)	Solids, liquid or gases
Good conductors of heat and electricity	Poor conductors of heat and electricity

CERAMICS AND GLASSES

A ceramic material is usually made from CLAY which has been heated to high temperatures in a kiln or oven. The high temperatures change the structure of the clay and gives it a new set of properties which are:

1. Good electrical insulators
2. High melting points
3. Resistant to heat – they are said to be REFRACTORY
4. Opaque (you cannot see through them)
5. Brittle but hard
6. Strong when you compress or squeeze them
7. Weak when you stretch them and apply tension
8. Chemically unreactive

Glasses have the same properties as ceramics but they are transparent (clear)

GLASS IS TRANSPARENT CERAMIC.

PLASTICS

Plastics are synthetic (man-made) materials made from large molecules.

Plastics have many useful properties

1. They are flexible and bend easily
2. Thermoplastics (main group of plastics) are easily melted and moulded
3. Colourings to the plastic are easy to add
4. Most burn quite easily but give off toxic (poisonous) gases

Plastics are generally NON-BIOEGRADABLE and do not naturally decay in the ground. They cause major problems when we want to dispose of them.

Ceramics are also non-biodegradable but glass is much easier to recycle than certain kinds of plastics.

TOPIC 6 CHEMICAL CHANGES

MEASURING ENERGY TRANSFERS

In most chemical reactions, heat is given to the outside. These chemical reactions GIVE OUT heat and are called EXOTHERMIC REACTIONS. There is a TEMPERATURE RISE.



The above reaction is called the THERMIT reaction. A mixture of aluminium powder and iron oxide powder is lit with a magnesium ribbon. The reaction is very violent as you can see. Lots of heat is produced. The result is MOLTEN IRON which is formed from rusty iron. The molten iron in the diagram is being used to weld together pieces of railway track.

In a small number of cases, energy is taken in and absorbed from the surroundings. The temperature goes DOWN. Salt makes ice melt at -15 Celsius. This is AN endothermic reaction.



All reactions involving the burning of fuels (COMBUSTION) are EXOTHERMIC. The energy transferred when a fuel burns can be measured by a CALORIMETRIC TECHNIQUE.

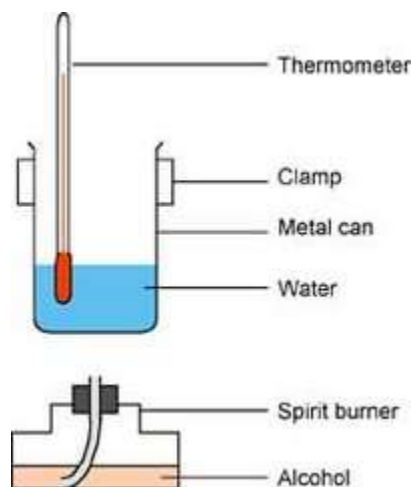

The rise in temperature of the water is a measure of the energy transferred to the water. This method above will NOT give a very accurate answer as heat can be lost in many ways – such as out of the metal can and from the sides of the metal can. Heat energy will also be lost from the top of the spirit burner And out into the laboratory.

Nevertheless, the technique can be used to compare the energy released by the same amount of different fuels.

The energy change can be calculated from the equation:

ΔH (amount of heat given to water) =

Mass of water (grams or kilograms) x specific heat capacity of water x temp. rise

The specific heat capacity of water is a FIXED TERM of $4.2 \text{ J/g/}^\circ\text{C}$

This term means it takes 4.2 JOULES OF ENERGY TO HEAT 1 GRAM OF WATER BY 1 CELSIUS.

Units are very important in this equation. When you use g for mass of water, your answer for heat given to water will be in J. However, if the mass is in KILOgrams, the answer for energy will be in KILOjoules.

Since 1cm^3 of water weighs 1g , the mass of water in the beaker is the SAME as the volume of water in cm^3 .

WORKED EXAMPLE

2.0grams of paraffin were burned in a spirit burner under a metal can containing 400cm^3 of water. The temperature of the water rose from 20°C to 70°C . Calculate the energy produced by the paraffin in J g^{-1} and KJ g^{-1} .

$$\text{EQUATION} \quad \Delta H = \text{mass of water} \times 4.2 \times \text{temperature change}$$

$$\Delta H = 400 \times 4.2 \times 50$$

$$\Delta H = 84000 \text{ J for every } 2 \text{ g of paraffin}$$

$$\Delta H = 42000 \text{ J g}^{-1}$$

$$\Delta H = 42 \text{ KJ g}^{-1}$$

ENERGY LEVEL DIAGRAMS AND ΔH

Here are the basic energy level diagrams to describe an EXOTHERMIC and an ENDOTHERMIC reaction.

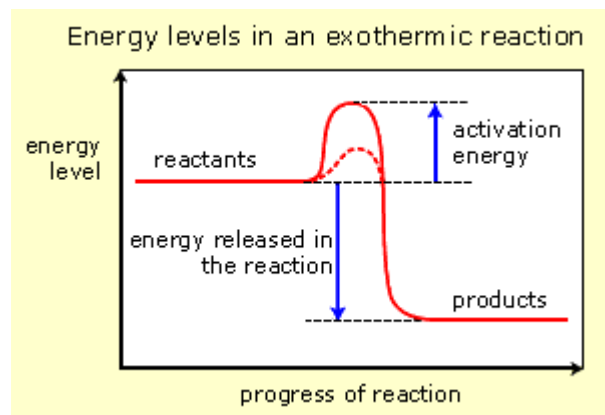

In an EXOTHERMIC REACTION, the energy of the starting chemicals (reactants) is HIGHER than the energy level of the products. This means HEAT IS GIVEN OUT AND LOST to the outside ΔH .

In an exothermic reaction, the energy released on forming new bonds is **GREATER THAN** the energy needed to break old bonds.

Activation energy is the **ENERGY NEEDED TO START** a chemical reaction.

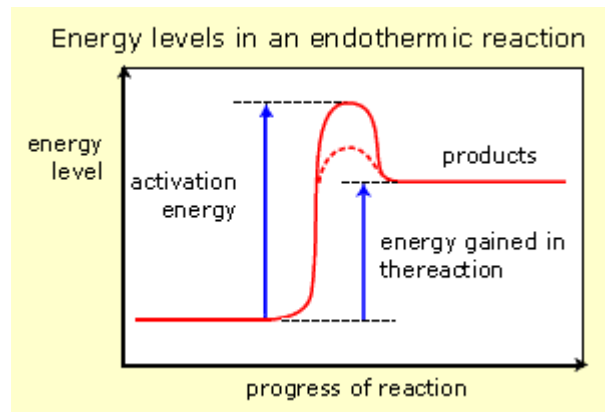

In an **ENDOTHERMIC REACTION**, the energy of the starting chemicals (reactants) is **LOWER** than the energy of the products. Heat is taken in. ΔH^+

In an endothermic reaction, more heat is needed to break bonds than the energy that is released when new bonds are formed. The energy changes in endothermic reactions are usually small.

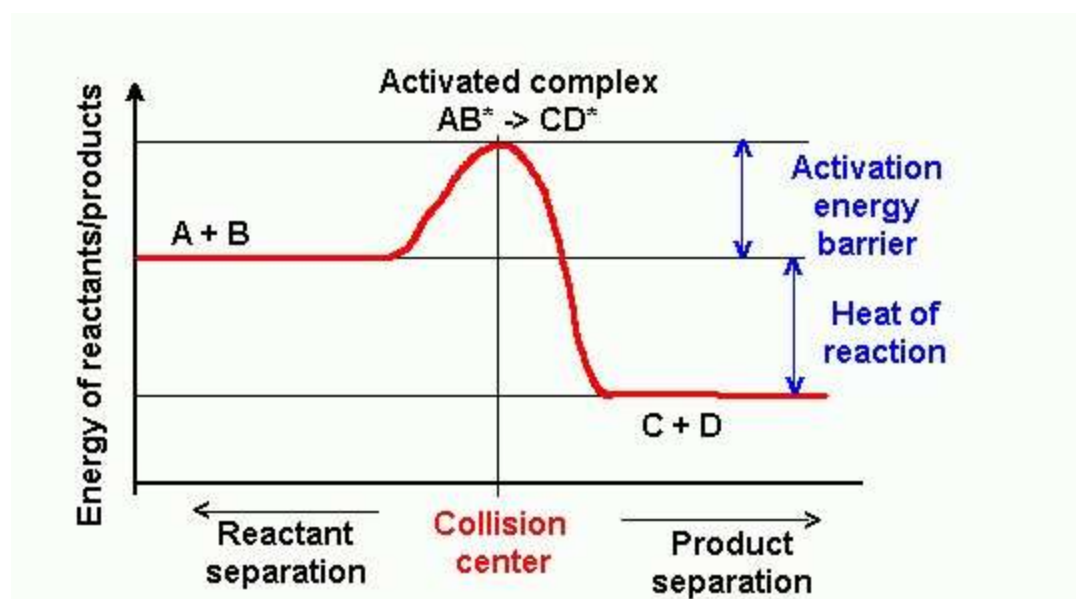

If heat is lost, activation energy will be MINUS for an EXOTHERMIC REACTION. If heat is gained, energy will be PLUS for an ENDOTHERMIC reaction.

PRODUCTION OF ENERGY

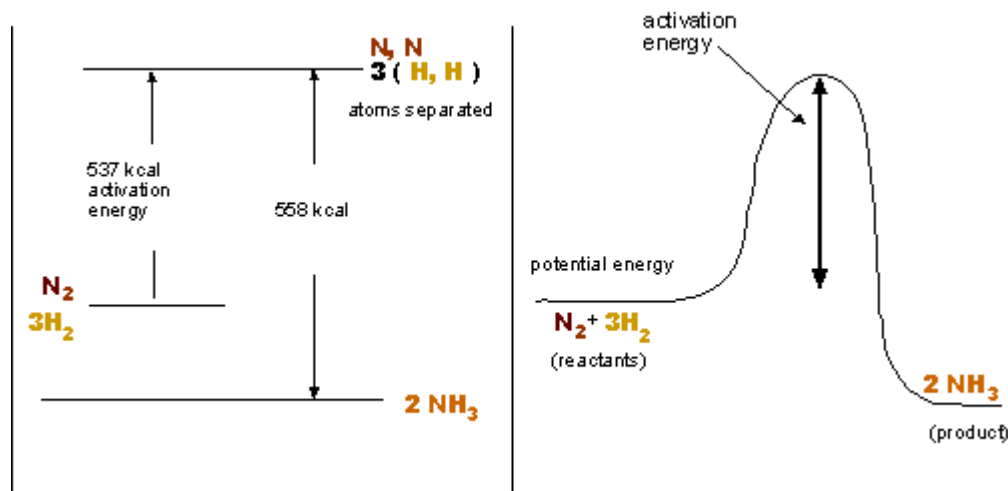

An important chemical reaction you will study later is the industrial manufacture of ammonia by the Haber Process. Here is an energy level diagram for that process.

In the first stage, the covalent bonds in nitrogen gas and oxygen gas are **BROKEN**.

In the second stage, the atoms combine and new covalent bonds are formed as **NEW AMMONIA MOLECULES** are made.

In stage 1, energy is needed and is **ABSORBED FROM THE SURROUNDINGS** to break the bonds. This process is **ENDOTHERMIC**.

BOND BREAKING IS AN ENDOTHERMIC PROCESS.

In stage 2, energy is released and **TRANSFERRED TO THE SURROUNDINGS** in formation of new bonds. This process is **EXOTHERMIC**.

MAKING NEW BONDS IS AN EXOTHERMIC PROCESS.

BURNING ALKANE FUELS IN ORGANIC CHEMISTRY

Alkanes are hydrocarbons. They are made of carbon atoms and hydrogen atoms joined together in a chain.

The larger the alkane molecule (more carbon atoms linked together in a chain), the more energy that is released in combustion. This is because, although more bonds need to be formed in the first stage of the reaction, more bonds are formed in the second stage.

The increase in energy released in combustion has been calculated per mole of alkane. You will see that as NUMBER OF CARBON ATOMS INCREASES, The ENERGY OF COMBUSTION also increases.

NAME OF ALKANE	NUMBER OF CARBON ATOMS	CHEMICAL FORMULA OF THE ALKANE	ENERGY OF COMBUSTION (KJ mol ⁻¹)
METHANE	1	CH ₄	882
ETHANE	2	C ₂ H ₆	1542
PROPANE	3	C ₃ H ₈	2202
BUTANE	4	C ₄ H ₁₀	2877
PENTANE	5	C ₅ H ₁₂	3487
HEXANE	6	C ₆ H ₁₄	4141

HYDROGEN AS A FUEL

The reaction between hydrogen gas and oxygen gas is VERY EXOTHERMIC. It produces lots of heat energy.

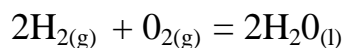

Burning only 2 grams of hydrogen gives out 485 joules of energy.

This reaction is used for powering space rockets using hydrogen as ROCKET FUEL.



ENERGY AND RADIOACTIVE ISOTOPES

Nuclear power stations use immense heat produced by the decay of radioactive isotopes. The heat that is generated is used to boil water to make steam which then turns a turbine. This produces the electricity.

Uranium-235 or U^{235} IS THE RADIOACTIVE ISOTOPE used as a fuel in nuclear reactors. The radioactive reaction produces heat energy

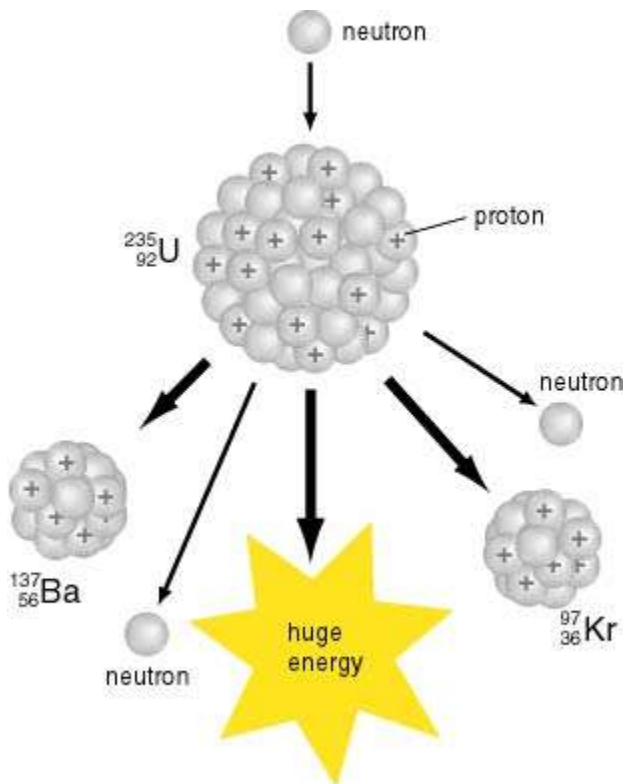

SIMPLE ELECTROCHEMICAL CELLS

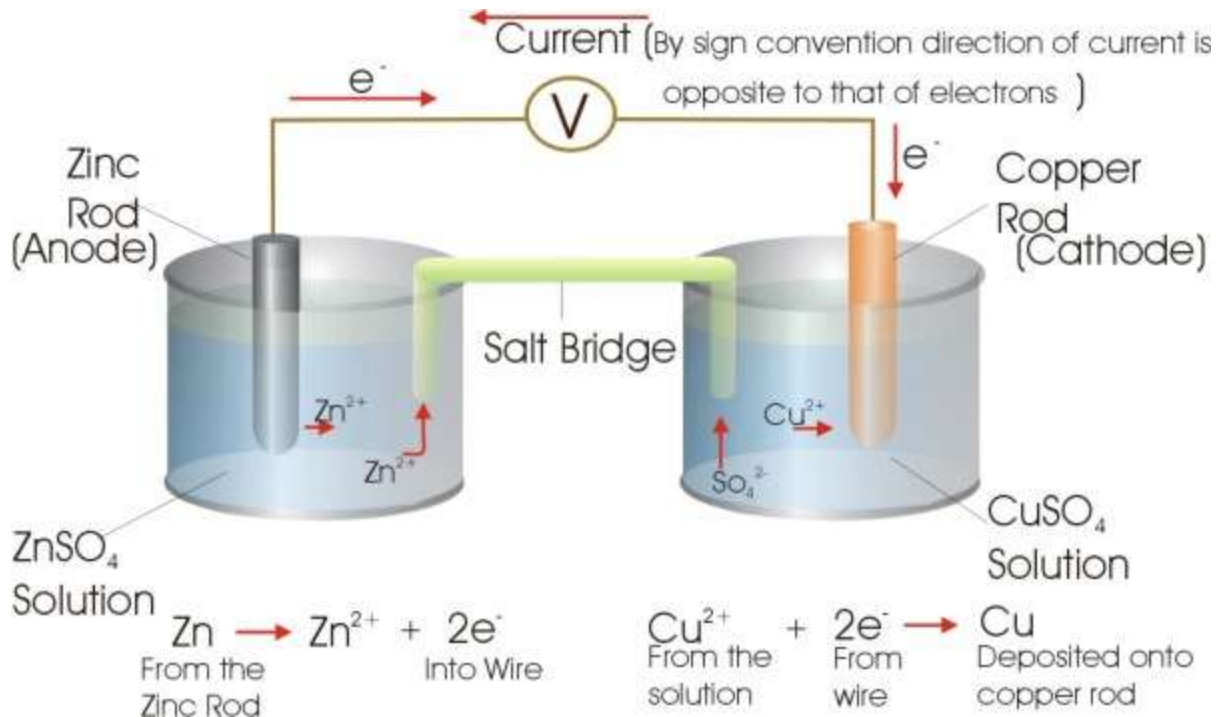

Metals and solutions of their own salts can be used to generate electricity. If the above experiment is set up, a bulb will glow showing that electricity has been produced in the zinc and copper half-cells.

Zinc is higher than copper in the reactivity series, so is the producer of electrons at THE CATHODE. The copper takes the electrons at THE ANODE.

The reactions are:

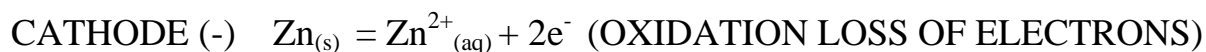

Please refer to the section in the next chapter (chapter 7) – refer to the section REDOX and see ‘OIL RIG’.

Although zinc/copper is used here as the example, you can get electricity from any pair of metals set up in a diagram like the one shown above.

The amount of electricity produced depends on the position of the metals in the reactivity series. The rule is:

THE FURTHER APART THE METALS ARE IN THE REACTIVITY SERIES – THE MORE ELECTRICITY WILL BE PRODUCED.

BATTERIES

The words ‘battery’ and ‘cell’ are often used to mean the same thing. A battery is MORE THAN ONE CELL WORKING TOGETHER.

Batteries range from the large lead/acid batteries used in cars, lorries and buses to tiny little lithium batteries used in hearing aids and watches.

Batteries are now used in mobile phones and i-pods and are now known as ‘mobile electricity carriers’.

Their impact on society is becoming a fascinating study.

Without batteries we would have no mobile phones or laptop computers which are now part of our everyday lives.

TOPIC 7 – RATES OF CHEMICAL REACTIONS

SPEED OF REACTION

A chemical change or a chemical reaction is very different from the physical changes that take place – for instance when we boil water.

A chemical reaction has many features.

One or more new substances are formed in a chemical reaction. In many cases, an **OBSERVABLE CHANGE** happens that we can see. There may be a colour change or a gas given off.

There may also be a **CHANGE IN MASS**. The chemical could be **DECOMPOSED** and **LOSE MASS** or could react with **OXYGEN GAS** , become **OXIDISED** and **INCREASE** in mass.

The change in mass though may be very difficult to detect unless an accurate balance is used. **MASS IS CONSERVED IN A CHEMICAL REACTION** – the apparent change in mass occurs because one of the reactants or products is a **GAS**.

AN ENERGY CHANGE IS ALMOST ALWAYS INVOLVED. In most cases energy is **RELEASED** and the surroundings become **WARMER**. In some cases, energy is **ABSORBED** from the surroundings so the surroundings get **COLDER**.

NOTE: SOME PHYSICAL CHANGES LIKE EVAPORATION ALSO PRODUCE ENERGY CHANGES.

COLLISION THEORY

For a chemical reaction to take place, the reacting particles *(atoms, molecules or ions) must **COLLIDE** or **SMASH INTO** each other. The energy involved in the collision must be enough to break the chemical bonds in the reacting particles – or the particles would just **BOUNCE OFF** each other.

A collision that has enough energy to result in a chemical reaction is called an **EFFECTIVE COLLISION**.

WHAT FACTORS CAN CHANGE RATE OF REACTION?

Six key factors can change the rate of a chemical reaction:

1. concentration of a solution
2. temperature
3. surface area of a solid
4. a catalyst
5. pressure of a gas
6. light

Simple collision theory can be used to explain how these factors affect the rate of a reaction.

Two important parts of the theory are:

1. THE REACTING PARTICLES MUST COLLIDE WITH EACH OTHER
2. THERE MUST BE ENOUGH ENERGY TO OVERCOME THE ACTIVATION ENERGY THAT IS NEEDED TO START THE CHEMICAL REACTION.

EFFECT OF CONCENTRATION ON REACTION RATE

Increasing the CONCENTRATION of a reactant will INCREASE the rate of a chemical reaction.

When a piece of magnesium ribbon is added to a solution of hydrochloric acid, the following reaction takes place:

Magnesium ribbon + hydrochloric acid = magnesium chloride + hydrogen gas

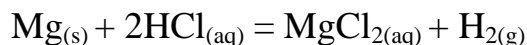

As the magnesium comes into contact with the hydrochloric acid, there is EFFERVESCENCE OR FIZZING. Hydrogen gas is made.

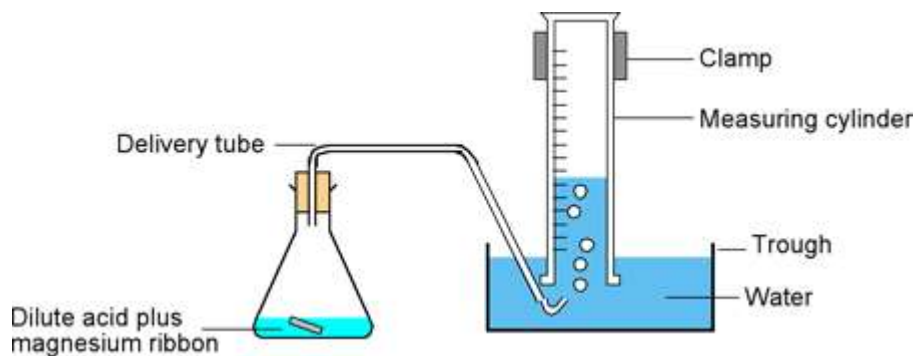

Some experiments were done using the same length of magnesium ribbon to make the experiment a FAIR TEST. Different concentrations of acid were used.

Four different experiments were done. The volume of hydrogen gas produced was recorded every minute for 6 minutes. A graph was plotted and is shown below:

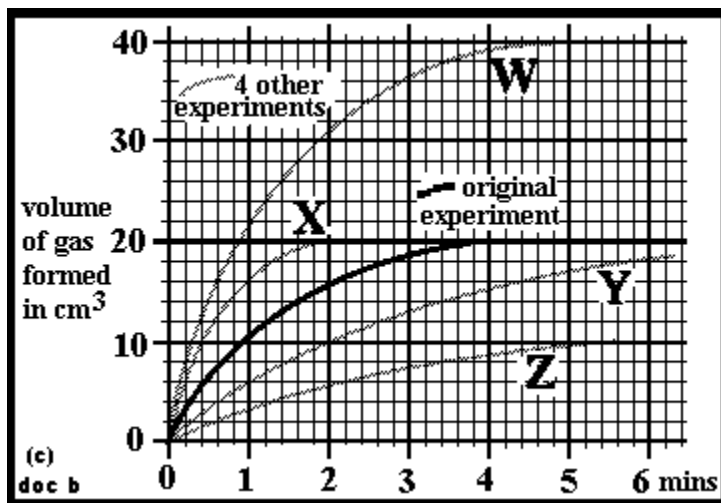

In the first experiment, W, very strong 2 mol dm^{-3} hydrochloric acid was used.

In experiment X we used 1.5 mol dm^{-3} hydrochloric acid, Y = 1.0 mol dm^{-3} hydrochloric acid and in experiment Z we used 0.5 mol dm^{-3} hydrochloric acid.

You can see that in experiment W with the stronger acid, MORE gas is formed in the given time. There is a faster reaction rate – steeper curve.

The reverse is true – weaker acid gives a much slower rate of reaction.

Some other examples include:

Zinc and hydrochloric acid

In the lab, zinc granules react fairly slowly with dilute hydrochloric acid, but much faster if the acid is concentrated.



The catalytic decomposition of hydrogen peroxide

Solid manganese(IV) oxide is often used as a catalyst in this reaction. Oxygen is given off much faster if the hydrogen peroxide is concentrated than if it is dilute.

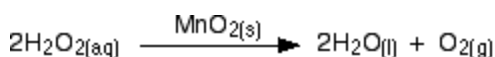

The reaction between sodium thiosulphate solution and hydrochloric acid

This is a reaction which is often used to explore the relationship between concentration and rate of reaction in introductory courses (like GCSE). When a dilute acid is added to sodium thiosulphate solution, a pale yellow precipitate of sulphur is formed.

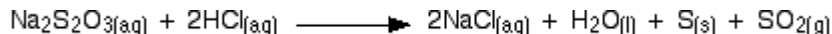

As the sodium thiosulphate solution is diluted more and more, the precipitate takes longer and longer to form.

EFFECT OF TEMPERATURE ON REACTION RATE

Increasing temperature will increase the rate of the chemical reaction. Warming a chemical transfers kinetic energy to the particles of the chemical. More kinetic energy means that the particles will move faster. As they are moving faster, the particles will collide more frequently every second. The increased energy of the collisions means that **THE NUMBER OF EFFECTIVE COLLISIONS PER SECOND** will **ALSO INCREASE**.

Increasing the temperature of the reaction – such as warming the acid in the rate of reaction between marble chips and hydrochloric acid will **NOT INCREASE** the amount of **CARBON DIOXIDE GAS** produced. **THE SAME AMOUNT OF CO₂ WILL BE MADE IN A SHORTER TIME**.

Collisions between molecules will be more violent at higher temperatures. The higher temperatures mean higher velocities. This means there will be less time between collisions. The frequency of collisions will increase. The increased number of collisions and the greater violence of collisions results in more **effective** collisions. The rate for the reaction increases. Reaction rates are roughly **doubled** when the temperature increases by **10 degrees Kelvin**. This means the rate can be quadrupled if the temperature is raised by 20 degrees Kelvin.

It should be clear that if you can increase reaction rates by increasing temperature you can decrease reaction rates by lowering the temperature. You do this every time you put something in the refrigerator. If you want to see the effect of elevated temperatures increased reaction rates you can leave some dairy product out of the refrigerator for a few days and compare its condition with the same age dairy product that was kept cold.

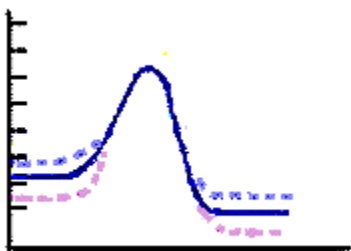

Temperature effects on rates and activation energy diagram

This illustration shows what happens to an exothermic reaction when the temperature is changed.

The dotted blue **curve** shows the energy for a reaction mixture that is heated. The reactants are "part way" up the energy barrier because they are "hot".

The dotted **magenta curve** shows what cooling does to the reactant energy. The energy goes down and the reaction happens with more difficulty.

NOTE: The energies of reactants and products have changed. They both have different energies because they were either heated or cooled. The heat of reaction is the slightly different. The relative amounts of reactants and products are slightly different because of the temperature changes.

EFFECT OF SURFACE AREA ON REACTION RATE

The more finely divided the solid is, the faster the reaction happens. A powdered solid will *normally* produce a faster reaction than if the same mass is present as a single lump. The powdered solid has a greater surface area than the single lump.

Some examples

Calcium carbonate and hydrochloric acid

In the lab, powdered calcium carbonate reacts much faster with dilute hydrochloric acid than if the same mass was present as lumps of marble or limestone.

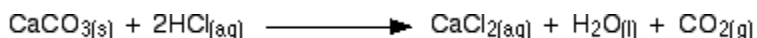

The catalytic decomposition of hydrogen peroxide

This is another familiar lab reaction. Solid manganese(IV) oxide is often used as the catalyst. Oxygen is given off much faster if the catalyst is present as a powder than as the same mass of granules.

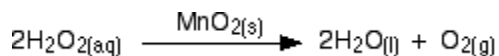

Catalytic converters

Catalytic converters use metals like platinum, palladium and rhodium to convert poisonous compounds in vehicle exhausts into less harmful things. For example, a reaction which removes both carbon monoxide and an oxide of nitrogen is:



Because the exhaust gases are only in contact with the catalyst for a very short time, the reactions have to be very fast. The extremely expensive metals used as the catalyst are coated as a very thin layer onto a ceramic honeycomb structure to maximise the surface area.

The explanation

You are only going to get a reaction if the particles in the gas or liquid collide with the particles in the solid. Increasing the surface area of the solid increases the chances of collision taking place.

Imagine a reaction between magnesium metal and a dilute acid like hydrochloric acid. The reaction involves collision between magnesium atoms and hydrogen ions.



Hydrogen ions can hit the outer layer of atoms . . .

. . . but not these in the centre of the lump.

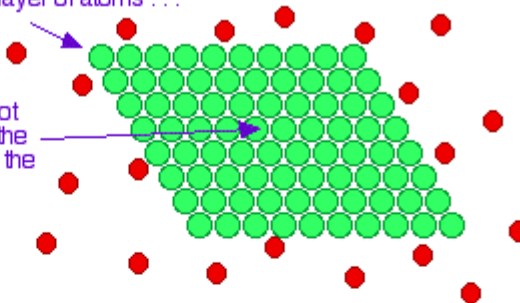

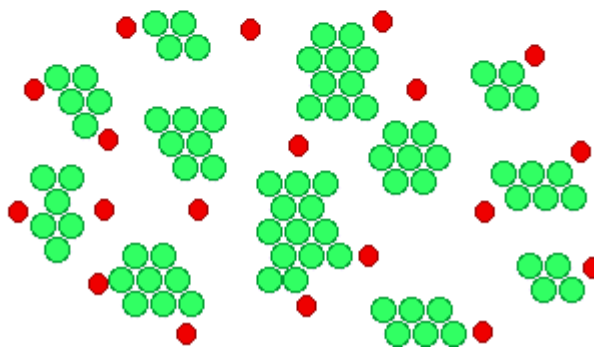

With the same number of atoms now split into lots of smaller bits, there are hardly any magnesium atoms which the hydrogen ions can't get at.

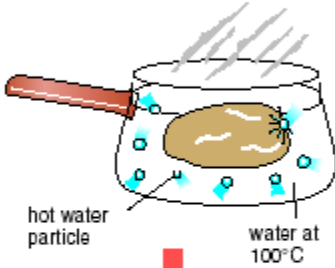
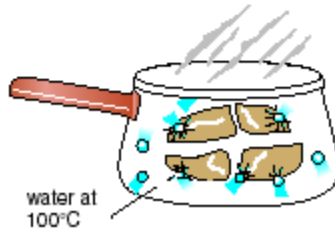
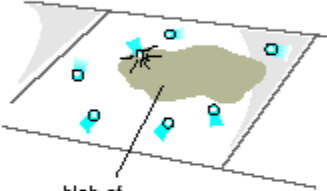
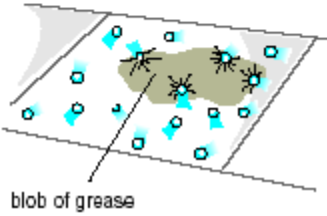

Increasing the number of collisions per second increases the rate of reaction.

SUMMARY OF RATES OF REACTION – 3 MOST IMPORTANT FACTORS

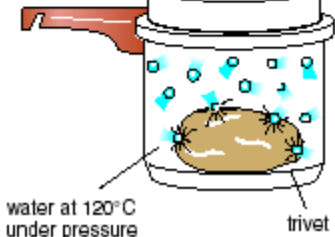
SURFACE AREA	CONCENTRATION	TEMPERATURE
In general, reactions go faster when there is more surface area to react.	In general, reactions go faster when the concentration of reactants is greater.	In general, reactions go faster at higher temperatures.
<p>Surface area of whole potato is low – few collisions with potato</p>  <p>↓</p> <p>Surface area of four quarters of potato is greater – more surface area exposed for collisions</p> 	<p>Concentration of bathroom cleaner is low – few collisions with grease blob</p>  <p>↓</p> <p>Concentration of bathroom cleaner is higher – more collisions with grease blob</p> 	<p>At lower temperature, water particles move slower, occasionally hitting the potato</p>  <p>↓</p> <p>At higher temperature, water particles move faster, colliding with the potato more often and with more energy</p> 

EFFECT OF CATALYSTS ON REACTION RATE

A catalyst is a substance which alters the rate of a chemical reaction but is chemically unchanged at the end of the reaction.

Why not memorise this definition?

"..... but is chemically unchanged at the end of the reaction." This means that there is just as much catalyst at the end of a reaction as there was at the beginning. The catalyst is used over and over again. Because catalysts work so rapidly and are used again and again, it is only necessary to have very small quantities of catalyst present to make a chemical reaction go faster.

You might have a "catalytic converter" in the exhaust pipe of your car. If the catalyst was Platinum you might expect silly people to start stealing car exhaust pipes; but there is so little catalyst there that it would not be worthwhile for them. A little bit of catalyst goes a long way! What does the catalytic converter do? Well without it the fumes from your car would cause too much pollution and the car might fail its MOT.

Perhaps you don't think that catalysts are very important.

"..... **alters the rate of a chemical reaction**" This means that catalysts make chemical reactions go faster. I am still looking for one which will make you do your homework faster, and another which will make me mark it faster. What about chemical reactions. Some of them go very slowly, your chemistry experiment might take hours, days, weeks, or even years. Imagine if your chemistry teacher asked you to find out what gas is released from Hydrogen Peroxide: you might have to sit there watching your test tube for weeks; your chemistry teacher would keep on asking why you had not finished your work. Eventually you would have enough gas to test; so weeks later you would say "Oh, it is Oxygen Miss." If you had put a little pinch of Manganese Dioxide into the test tube, the gas would be produced in a few minutes. So, you would be able to go long before the end of the lesson. Even better, you would still have the Manganese Dioxide catalyst which you would be able to sell back to your teacher to use with another class.

How about the chemical industry. Well they will make much more money if they can make their products quickly. The manufacturers of Nitric Acid use Platinum as a catalyst. Even though this is a very expensive metal, it does not cost too much to use it because they are only using small amounts of it.

"**A catalyst is a substance**" This means that it is some kind of chemical substance! It could be a pure element; e.g. Platinum, Nickel; or it could be a pure compound, e.g. Manganese Dioxide, Silica, Vanadium V Oxide, Iron III Oxide; it could be dissolved ions, e.g. Copper ions, Cobalt II ions; or it could be a mixture, e.g. Iron-Molybdenum, or it could be a much more complicated compound such as protein (all enzymes are proteins; you learn about them in your biology; they are special cases.)

Enzymes are biological catalysts. They are slightly different in that they are easily denatured by heat

Most catalysts make chemical reactions go faster. Chemists call such catalysts "positive catalysts" or "promoters". However, sometimes we want a chemical reaction to go more slowly. So we choose a "negative catalyst"; we could call this an "inhibitor". My wife put a negative catalyst in our central heating system. She did this to stop the iron bits from rusting. We did not have a problem with the Copper pipes (Copper does not rust), but we might have had a problem with the old Iron radiators: we wanted to stop them from rusting so we used an inhibitor. I think that we also have an inhibitor in the water cooling system of our car so that the car radiator does not rust. This is cheaper than buying a new car every year when the old one has got too rusty.

My baker puts an inhibitor into the bread he makes. This slows down the chemical reactions which make bread go stale. This is important since we only go shopping once a week. We used to put Lead in our petrol; this stops the engine from "knocking". Now we have a better car which uses lead free petrol but the engine can burn it without knocking.

You might wonder how catalysts work.

There are two ways in which catalysts work. You already know that when two different molecules bump into each other, they might react to make new chemicals. We usually talk about "collisions" between molecules, it would be much simpler to say that the molecules bumped into each other. How fast a chemical reaction is depends upon how frequently the molecules collide. You have probably been told about the "kinetic theory" which is all about heat and how fast molecules move around. What catalysts are doing when they make a chemical reaction go faster is to increase the chance of molecules colliding. The first method is by "adsorption", the second method is by the formation of intermediate compounds.

Adsorption This occurs when a molecule sticks onto the surface of a catalyst. Make sure that you spell this word correctly; it is not the same as absorption. Here is an example: it is possible to use Platinum as a catalyst to make sulphur Trioxide from Sulphur Dioxide and Oxygen. Sulphur Trioxide is very important because it is used to make Sulphuric acid which is needed for car batteries. The molecules of the two gases (Sulphur Dioxide and Oxygen) get adsorbed (stuck onto) the surface of a Platinum catalyst. Because the two molecules are held so close together, it is more likely that they will collide and therefore react with each other. The Sulphur Trioxide easily falls off the catalyst leaving space for more Sulphur Trioxide and Oxygen.

Intermediate Compounds Many catalysts, including all enzymes" work by forming intermediate compounds. What happens is very simple: the chemicals involved in the reaction combine with the catalyst making an intermediate compound, but this new compound is very unstable. When the intermediate compound breaks down it releases the new compounds and the original catalyst.

Well: if you have understood all this, it should be easy to memorise the definition of a catalyst given at the top of the section.

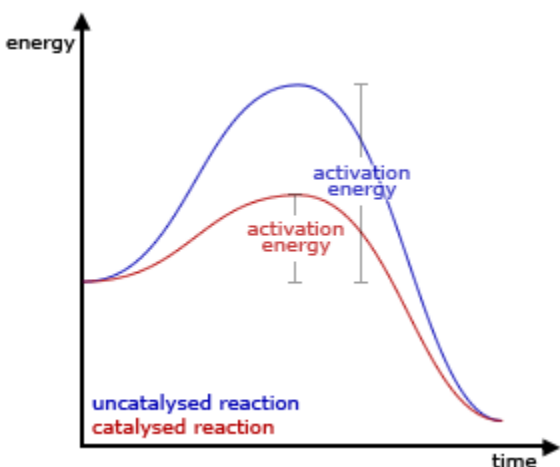

Catalysts lower the activation energy of a chemical reaction and provide a lower energy route from reactants to products.

EFFECT OF PRESSURE ON REACTION RATES

Increasing the pressure on a reaction involving reacting gases increases the rate of reaction. Changing the pressure on a reaction which involves only solids or liquids has no effect on the rate.

An example

In the manufacture of ammonia by the Haber Process, the rate of reaction between the hydrogen and the nitrogen is increased by the use of very high pressures.

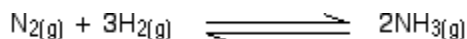

In fact, the main reason for using high pressures is to improve the percentage of ammonia in the equilibrium mixture, but there is a useful effect on rate of reaction as well.

The explanation

The relationship between pressure and concentration

Increasing the pressure of a gas is exactly the same as increasing its concentration. If you have a given mass of gas, the way you increase its pressure is to squeeze it into a smaller volume. If you have the same mass in a smaller volume, then its concentration is higher.

You can also show this relationship mathematically if you have come across the *ideal gas equation*:

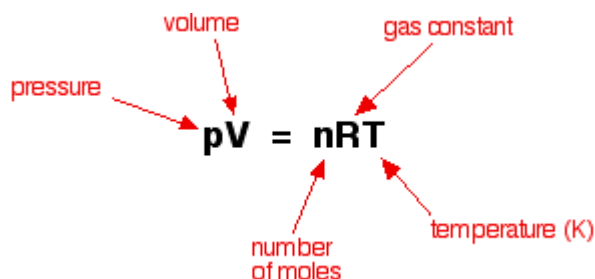

Rearranging this gives:

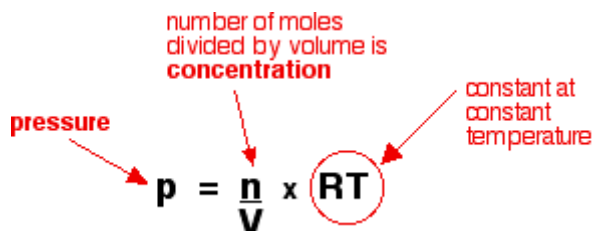

Because "RT" is constant as long as the temperature is constant, this shows that the pressure is directly proportional to the concentration. If you double one, you will also double the other.

The effect of increasing the pressure on the rate of reaction

Collisions involving two particles

The same argument applies whether the reaction involves collision between two different particles or two of the same particle.

In order for any reaction to happen, those particles must first collide. This is true whether both particles are in the gas state, or whether one is a gas and the other a solid. If the pressure is higher, the chances of collision are greater.

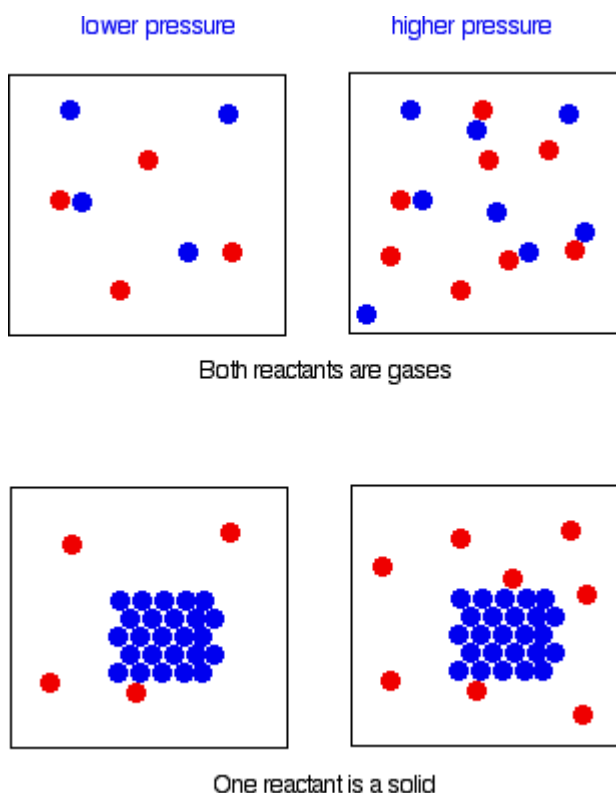

Reactions involving only one particle

If a reaction only involves a single particle splitting up in some way, then the number of collisions is irrelevant. What matters now is how many of the particles have enough energy to react at any one time.

Suppose that at any one time 1 in a million particles have enough energy to equal or exceed the activation energy. If you had 100 million particles, 100 of them would react. If you had 200 million particles in the same volume, 200 of them would now react. The rate of reaction has doubled by doubling the pressure.

EFFECT OF LIGHT ON CHEMICAL REACTIONS

Visible light or ultra-violet light can start or even speed up a chemical reaction.

In photography, a camera film is coated with silver compounds called silver chloride (AgCl), silver bromide (AgBr) and silver iodide (AgI).

All three are sensitive to light but have different rates of sensitivity.

When light hits the camera film, the silver ions gain electrons to form silver metal. This is called reduction.

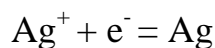

Light energy speeds up this process of reduction.

When the film is developed to produce negative images, these show the dark and light patches of the picture that was taken like shown below:



The darker areas contain the most silver, the lighter areas contain the least silver.

Here is the positive image that forms when the film has been developed.



The silver salts need to be kept in the dark but even then they do slowly change into silver metal over a period of time. This is why photographic film has a 'use by' date. If we use it after this time, all the silver salts will actually be silver and the film will be completely useless.

PHOTOSYNTHESIS is also started by ultraviolet (UV) light being absorbed by the green pigment chlorophyll in the leaves of green plants.

Carbon dioxide + water = glucose + oxygen

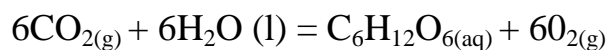

PROBLEMS WITH FAST REACTIONS

When reactions get faster and faster, there is a huge risk of explosions.

Powders have very fine particles with a huge surface area. Powders can be explosive. Even finely divided flour in bread making has caused explosions with tiny sparks at a flour mill. Coal dust in mines also causes explosions.

REVERSIBLE REACTIONS

What is a reversible reaction?

Many reactions, such as fuels burning, are irreversible - they go to completion and cannot easily be reversed. Reversible reactions are different. In a reversible reaction the **products** can react to produce the original **reactants** again.

When writing chemical equations for reversible reactions, we do not use the usual one-way arrow. Instead, we use two arrows, each with just half an arrowhead - the top one pointing right and the bottom one pointing left. For example

ammonium chloride \rightleftharpoons ammonia + hydrogen chloride

The equation shows that ammonium chloride (a white solid) can break down to form ammonia and hydrogen chloride. It also shows that ammonia and hydrogen chloride (colourless gases) can react to form ammonium chloride again.

A very important example of a reversible reaction involving white anhydrous copper(II) sulphate and blue hydrated copper(II) sulphate, the equation for which is

anhydrous copper(II) sulphate + water \rightleftharpoons hydrated copper(II) sulphate

WHITE

BLUE

If we heat the **hydrated copper(II) sulphate (BLUE)** it turns into **white anhydrous copper(II) sulphate. STEAM is produced.**

If we let the white crystals cool, we can add water again, they turn blue again and we can do this process as many times as we like.

If a chemical reaction happens in a container in which one or more of the **reactants** or **products** can escape, you have an **open system**. If a chemical reaction happens in a container in which none of the reactants or products can escape, you have a **closed system**. **Reversible reactions** that happen in a closed system eventually reach an **equilibrium**.

Chemical equilibrium

In a chemical equilibrium the concentrations of reactants and products do not change. But the forward and reverse reactions have not stopped - **they are still going on, but at the same rate as each other**.

Imagine walking the wrong way on an escalator - at the same speed as the escalator, but in the opposite direction. Your legs would still be walking forwards, and the escalator would continue to move backwards - but the net result would be that you stay in exactly the same place. This is what happens in an equilibrium.

Changes

If we remove the products from an equilibrium mixture, more reactants are converted to products. If a **catalyst** is used, the reaction reaches equilibrium much sooner because the catalyst speeds up the forward and reverse reactions by the same amount. However the concentration of reactants and products is the same at equilibrium as it would be without the catalyst.

For the Higher Tier you need to know what happens to the amount of product in an equilibrium mixture if the **temperature** is changed.

- If the forward reaction is **exothermic** and the temperature is increased, the yield of products is decreased. If the temperature is decreased, the yield of products is increased.
- If the forward reaction is **endothermic** and the temperature is increased, the yield of products is increased. If the temperature is decreased, the yield of products is decreased.

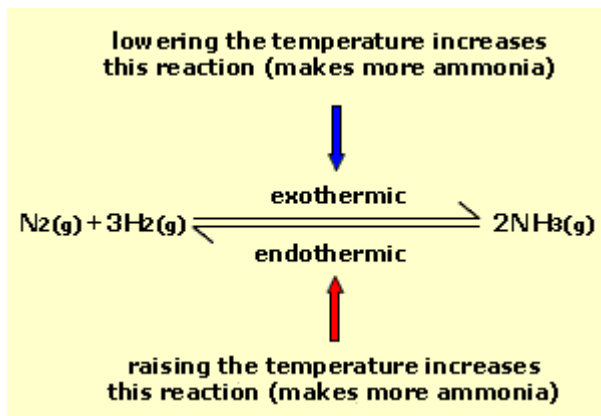

Haber process: effect of temperature change on yield of ammonia

This is important for industrial processes such as the Haber process. The forward reaction, which makes ammonia for fertilisers, is exothermic, so the yield of ammonia is better at lower temperatures. You might think that the chemical engineers would choose a low temperature for the Haber process - but the reaction runs much faster at higher temperatures. So a compromise temperature is chosen instead; high enough to get a reasonable rate of reaction, but not so high that the yield of ammonia is low.

For the Higher Tier you also need to know what happens to the amount of **product** in an equilibrium mixture of gases if the **pressure** is changed.

Count the molecules in the equation

Changing the pressure has little effect on an equilibrium mixture without gases - but can have a big effect on an equilibrium mixture containing gases. If the pressure is increased, the position of equilibrium moves in the **direction of the fewest molecules**.

Look again at the Haber process, which makes ammonia (NH_3):

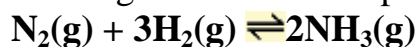

On the left there are $1 + 3 = 4$ molecules of gas. On the right there are two molecules of gas. If the pressure is increased, the position of equilibrium will move to the right and more ammonia will be made. If the pressure is reduced, the position of equilibrium will move to the left and less ammonia will be made.

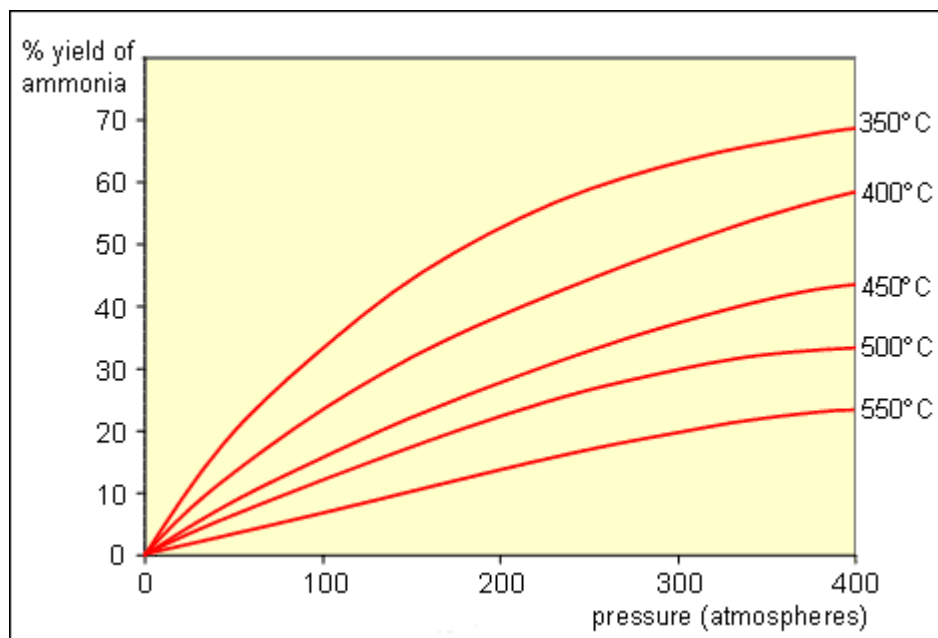

Look at the graph. You can see that for any given temperature the **yield of ammonia increases as the pressure increases**. You can also see that for any given pressure, the **yield goes down as the temperature increases**. This is because the forward reaction is **exothermic**.

CHANGING THE POSITION OF EQUILIBRIUM

Reversible reactions can be a nuisance to a Chemist working on an industrial (massive) scale.

You are trying to make as much product as you can but as soon as it starts to form, it starts going back into reactants!

Scientists have found ways of increasing the amount of YIELD (PRODUCT) FORMED by moving the position of the equilibrium (balance) to make more products and not more reactants. They can do this by

1. Changing concentrations
2. Changing pressure for reactions only involving gases
3. Changing temperature for reactions only involving gases

Here is an example

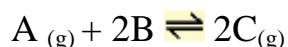

You can increase the yield of C by:

1. Adding more A and B
2. Removing C
3. Increasing the pressure because there are 3 molecules on left (high pressure) but only 2 molecules on the right (low pressure)
4. Increasing the temperature because the reaction is ENDOTHERMIC (ΔH^+)

REDOX REACTIONS

Oxidation and reduction in terms of oxygen transfer

Definitions

- Oxidation is gain of oxygen.
- Reduction is loss of oxygen.

For example, in the extraction of iron from its ore:

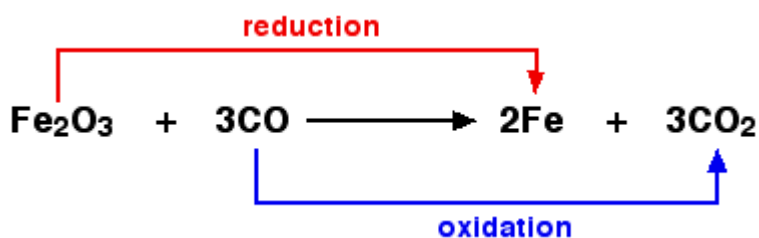

Because both *re*duction and *ox*idation are going on side-by-side, this is known as a *redox* reaction.

Oxidising and reducing agents

An oxidising agent is substance which oxidises something else. In the above example, the iron(III) oxide is the oxidising agent.

A reducing agent reduces something else. In the equation, the carbon monoxide is the reducing agent.

- Oxidising agents give oxygen to another substance.
- Reducing agents remove oxygen from another substance.

Oxidation and reduction in terms of hydrogen transfer

These are old definitions which aren't used very much nowadays. The most likely place you will come across them is in organic chemistry.

Definitions

- Oxidation is loss of hydrogen.
- Reduction is gain of hydrogen.

Notice that these are exactly the opposite of the oxygen definitions.

For example, ethanol can be oxidised to ethanal:

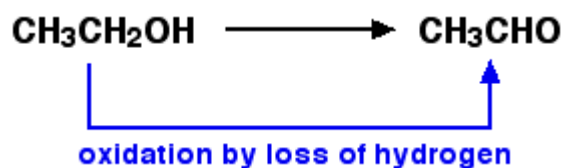

You would need to use an oxidising agent to remove the hydrogen from the ethanol. A commonly used oxidising agent is potassium dichromate(VI) solution acidified with dilute sulphuric acid.

Ethanal can also be reduced back to ethanol again by adding hydrogen to it. A possible reducing agent is sodium tetrahydridoborate, NaBH_4 . Again the equation is too complicated to be worth bothering about at this point.

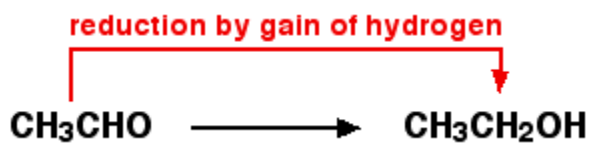

An update on oxidising and reducing agents

- Oxidising agents give oxygen to another substance or remove hydrogen from it.
- Reducing agents remove oxygen from another substance or give hydrogen to it.

Oxidation and reduction in terms of electron transfer

Definitions

- *Oxidation is loss of electrons.*
- *Reduction is gain of electrons.*

It is essential that you remember these definitions. There is a very easy way to do this. As long as you remember that you are talking about electron transfer:

OIL RIG

oxidation is loss reduction is gain

A simple example

The equation shows a simple redox reaction which can obviously be described in terms of oxygen transfer.



Copper(II) oxide and magnesium oxide are both ionic. The metals obviously aren't. If you rewrite this as an ionic equation, it turns out that the oxide ions are spectator ions and you are left with:

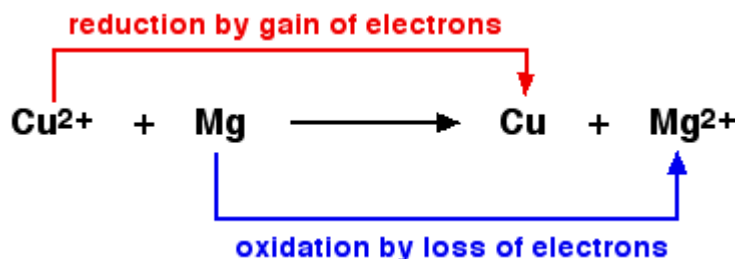

A last comment on oxidising and reducing agents

If you look at the equation above, the magnesium is reducing the copper(II) ions by giving them electrons to neutralise the charge. Magnesium is a reducing agent.

Looking at it the other way round, the copper(II) ions are removing electrons from the magnesium to create the magnesium ions. The copper(II) ions are acting as an oxidising agent.

Warning!

This is potentially very confusing if you try to learn both what oxidation and reduction mean in terms of electron transfer, and also learn definitions of oxidising and reducing agents in the same terms.

Personally, I would recommend that you work it out if you need it. The argument (going on inside your head) would go like this if you wanted to know, for example, what an oxidising agent did in terms of electrons:

- An oxidising agent oxidises something else.
- Oxidation is loss of electrons (OIL RIG).
- That means that an oxidising agent takes electrons from that other substance.
- So an oxidising agent must gain electrons.

Or you could think it out like this:

- An oxidising agent oxidises something else.
- That means that the oxidising agent must be being reduced.
- Reduction is gain of electrons (OIL RIG).
- So an oxidising agent must gain electrons.

Understanding is a lot safer than thoughtless learning!

Electron-half-equations

What is an electron-half-equation?

When magnesium reduces hot copper(II) oxide to copper, the ionic equation for the reaction is:



You can split the ionic equation into two parts, and look at it from the point of view of the magnesium and of the copper(II) ions separately. This shows clearly that the magnesium has lost two electrons, and the copper(II) ions have gained them.

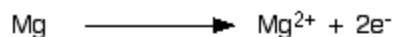

These two equations are described as "electron-half-equations" or "half-equations" or "ionic-half-equations" or "half-reactions" - lots of variations all meaning exactly the same thing!

Any redox reaction is made up of two half-reactions: in one of them electrons are being lost (an oxidation process) and in the other one those electrons are being gained (a reduction process).

Working out electron-half-equations and using them to build ionic equations

In the example above, we've got at the electron-half-equations by starting from the ionic equation and extracting the individual half-reactions from it. That's doing everything entirely the wrong way round!

In reality, you almost always start from the electron-half-equations and use them to build the ionic equation.

The reaction between chlorine and iron(II) ions

Chlorine gas oxidises iron(II) ions to iron(III) ions. In the process, the chlorine is reduced to chloride ions.

You would have to know this, or be told it by an examiner. In building equations, there is quite a lot that you can work out as you go along, but you have to have somewhere to start from!

You start by writing down what you know for each of the half-reactions. In the chlorine case, you know that chlorine (as molecules) turns into chloride ions:

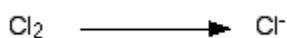

The first thing to do is to balance the atoms that you have got as far as you possibly can:

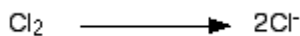

ALWAYS check that you have the existing atoms balanced before you do anything else. If you forget to do this, everything else that you do afterwards is a complete waste of time!

Now you have to add things to the half-equation in order to make it balance completely.

All you are allowed to add are:

- electrons
- water
- hydrogen ions (unless the reaction is being done under alkaline conditions - in which case, you can add hydroxide ions instead)

In the chlorine case, all that is wrong with the existing equation that we've produced so far is that the charges don't balance. The left-hand side of the equation has no charge, but the right-hand side carries 2 negative charges.

That's easily put right by adding two electrons to the left-hand side. The final version of the half-reaction is:



Now you repeat this for the iron(II) ions. You know (or are told) that they are oxidised to iron(III) ions. Write this down:



The atoms balance, but the charges don't. There are 3 positive charges on the right-hand side, but only 2 on the left.

You need to reduce the number of positive charges on the right-hand side. That's easily done by adding an electron to that side:



Combining the half-reactions to make the ionic equation for the reaction

What we've got at the moment is this:

This reaction needs 2 electrons . . .



. . . but this is only producing 1 electron

It is obvious that the iron reaction will have to happen twice for every chlorine molecule that reacts. Allow for that, and then add the two half-equations together.

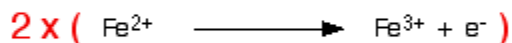
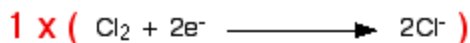

But don't stop there!! Check that everything balances - atoms and charges. It is very easy to make small mistakes, especially if you are trying to multiply and add up more complicated equations.

You will notice that I haven't bothered to include the electrons in the added-up version. If you think about it, there are bound to be the same number on each side of the final equation, and so they will cancel out. If you aren't happy with this, write them down and then cross them out afterwards!

OXIDATION STATES – OXIDATION NUMBERS

Oxidation states simplify the whole process of working out what is being oxidised and what is being reduced in redox reactions. However, for the purposes of this introduction, it would be helpful if you knew about:

- oxidation and reduction in terms of electron transfer
- electron-half-equations

We are going to look at some examples from vanadium chemistry. If you don't know anything about vanadium, it doesn't matter in the slightest.

Vanadium forms a number of different ions - for example, V^{2+} and V^{3+} . If you think about how these might be produced from vanadium metal, the $2+$ ion will be formed by oxidising the metal by removing two electrons:



The vanadium is now said to be in an oxidation state of +2.

Removal of another electron gives the V^{3+} ion:



The vanadium now has an oxidation state of +3.

Removal of another electron gives a more unusual looking ion, VO^{2+} .

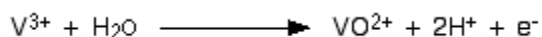

The vanadium is now in an oxidation state of +4. Notice that the oxidation state isn't simply counting the charge on the ion (that was true for the first two cases but not for this one).

The positive oxidation state is counting the total number of electrons which have had to be removed - starting from the element.

It is also possible to remove a fifth electron to give another ion (easily confused with the one before!). The oxidation state of the vanadium is now +5.

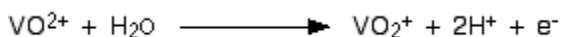

Every time you oxidise the vanadium by removing another electron from it, its oxidation state increases by 1.

Fairly obviously, if you start adding electrons again the oxidation state will fall. You could eventually get back to the element vanadium which would have an oxidation state of zero.

What if you kept on adding electrons to the element? You can't actually do that with vanadium, but you can with an element like sulphur.

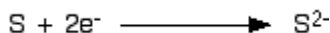

The sulphur has an oxidation state of -2.

Summary

Oxidation state shows the total number of electrons which have been removed from an element (a positive oxidation state) or added to an element (a negative oxidation state) to get to its present state.

Oxidation involves an increase in oxidation state

Reduction involves a decrease in oxidation state

Recognising this simple pattern is the single most important thing about the concept of oxidation states. If you know how the oxidation state of an element changes during a reaction, you can instantly tell whether it is being oxidised or reduced without having to work in terms of electron-half-equations and electron transfers.

Working out oxidation states

You *don't* work out oxidation states by counting the numbers of electrons transferred. Instead you learn some simple rules, and do some very simple sums!

- The oxidation state of an uncombined element is zero. That's obviously so, because it hasn't been either oxidised or reduced yet! This applies whatever the structure of the element - whether it is, for example, Xe or Cl₂ or S₈, or whether it has a giant structure like carbon or silicon.
- The sum of the oxidation states of all the atoms or ions in a neutral compound is zero.
- The sum of the oxidation states of all the atoms in an ion is equal to the charge on the ion.
- The more electronegative element in a substance is given a negative oxidation state. The less electronegative one is given a positive oxidation state. Remember that fluorine is the most electronegative element with oxygen second.
- Some elements almost always have the same oxidation states in their compounds:

element	usual oxidation state	exceptions
Group 1 metals	always +1	
Group 2 metals	always +2	
Oxygen	usually -2	except in peroxides and F ₂ O (see below)
Hydrogen	usually +1	except in metal hydrides where it is -1 (see below)
Fluorine	always -1	
Chlorine	usually -1	except in compounds with O or F

The reasons for the exceptions

Hydrogen in the metal hydrides

Metal hydrides include compounds like sodium hydride, NaH. In this, the hydrogen is present as a hydride ion, H⁻. The oxidation state of a simple ion like hydride is equal to the charge on the ion - in this case, -1.

Alternatively, you can think of it that the sum of the oxidation states in a neutral compound is zero. Since Group 1 metals always have an oxidation state of +1 in their compounds, it follows that the hydrogen must have an oxidation state of -1 (+1 -1 = 0).

Oxygen in peroxides

Peroxides include hydrogen peroxide, H₂O₂. This is an electrically neutral compound and so the sum of the oxidation states of the hydrogen and oxygen must be zero.

Since each hydrogen has an oxidation state of +1, each oxygen must have an oxidation state of -1 to balance it.

Oxygen in F₂O

The problem here is that oxygen isn't the most electronegative element. The fluorine is more electronegative and has an oxidation state of -1. In this case, the oxygen has an oxidation state of +2.

Chlorine in compounds with fluorine or oxygen

There are so many different oxidation states that chlorine can have in these, that it is safer to simply remember that the chlorine *doesn't* have an oxidation state of -1 in them, and work out its actual oxidation state when you need it. You will find an example of this below.

Warning!

Don't get too bogged down in these exceptions. In most of the cases you will come across, they don't apply!

Examples of working out oxidation states

What is the oxidation state of chromium in Cr^{2+} ?

That's easy! For a simple ion like this, the oxidation state is the charge on the ion - in other words: +2 (Don't forget the + sign.)

What is the oxidation state of chromium in CrCl_3 ?

This is a neutral compound so the sum of the oxidation states is zero. Chlorine has an oxidation state of -1. If the oxidation state of chromium is **n**:

$$n + 3(-1) = 0$$

$$n = +3 \text{ (Again, don't forget the + sign!)}$$

What is the oxidation state of chromium in the dichromate ion, $\text{Cr}_2\text{O}_7^{2-}$?

The oxidation state of the oxygen is -2, and the sum of the oxidation states is equal to the charge on the ion. Don't forget that there are 2 chromium atoms present.

$$2n + 7(-2) = -2$$

$$n = +6$$

What is the oxidation state of copper in CuSO_4 ?

Unfortunately, it isn't always possible to work out oxidation states by a simple use of the rules above. The problem in this case is that the compound contains two elements (the copper and the sulphur) whose oxidation states can both change.

The only way around this is to know some simple chemistry! There are two ways you might approach it. (There might be others as well, but I can't think of them at the moment!)

- You might recognise this as an ionic compound containing copper ions and sulphate ions, SO_4^{2-} . To make an electrically neutral compound, the copper must be present as a 2+ ion. The oxidation state is therefore +2.

- You might recognise the formula as being copper(II) sulphate. The "(II)" in the name tells you that the oxidation state is 2 (see below).

You will know that it is +2 because you know that metals form positive ions, and the oxidation state will simply be the charge on the ion.

Using oxidation states

In naming compounds

You will have come across names like iron(II) sulphate and iron(III) chloride. The (II) and (III) are the oxidation states of the iron in the two compounds: +2 and +3 respectively. That tells you that they contain Fe^{2+} and Fe^{3+} ions.

This can also be extended to the negative ion. Iron(II) sulphate is FeSO_4 . There is also a compound FeSO_3 with the old name of iron(II) sulphite. The modern names reflect the oxidation states of the sulphur in the two compounds.

The sulphate ion is SO_4^{2-} . The oxidation state of the sulphur is +6 (work it out!). The ion is more properly called the sulphate(VI) ion.

The sulphite ion is SO_3^{2-} . The oxidation state of the sulphur is +4 (work that out as well!). This ion is more properly called the sulphite(IV) ion. The **ite** ending simply shows that the sulphur is in a negative ion.

So FeSO_4 is properly called iron(II) sulphate(VI), and FeSO_3 is iron(II) sulphite(IV). In fact, because of the easy confusion between these names, the old names sulphate and sulphite are normally still used in introductory chemistry courses.

Using oxidation states to identify what's been oxidised and what's been reduced

This is easily the most common use of oxidation states.

Remember:

Oxidation involves an increase in oxidation state

Reduction involves a decrease in oxidation state

In each of the following examples, we have to decide whether the reaction involves redox, and if so what has been oxidised and what reduced.

Example 1:

This is the reaction between magnesium and hydrochloric acid or hydrogen chloride gas:



Have the oxidation states of anything changed? Yes they have - you have two elements which are in compounds on one side of the equation and as uncombined elements on the other. Check all the oxidation states to be sure:.

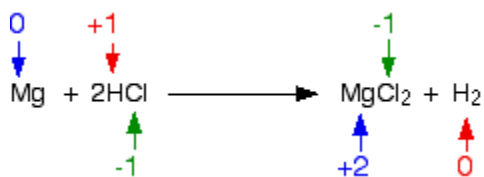

The magnesium's oxidation state has increased - it has been oxidised. The hydrogen's oxidation state has fallen - it has been reduced. The chlorine is in the same oxidation state on both sides of the equation - it hasn't been oxidised or reduced.

Example 2:

The reaction between sodium hydroxide and hydrochloric acid is:

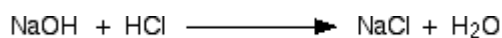

Checking all the oxidation states:

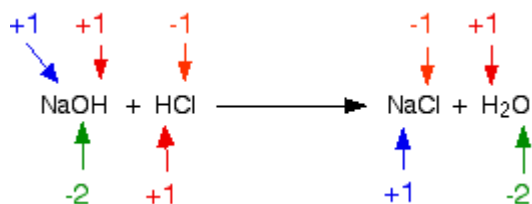

Nothing has changed. This isn't a redox reaction.

Example 3:

This is a sneaky one! The reaction between chlorine and cold dilute sodium hydroxide solution is:

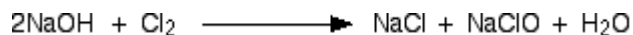

Obviously the chlorine has changed oxidation state because it has ended up in compounds starting from the original element. Checking all the oxidation states shows:

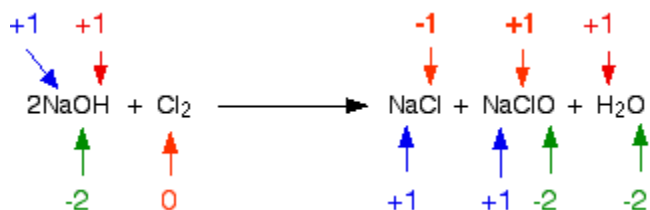

The chlorine is the *only* thing to have changed oxidation state. Has it been oxidised or reduced? Yes! Both! One atom has been reduced because its oxidation state has fallen. The other has been oxidised.

This is a good example of a **disproportionation** reaction. A disproportionation reaction is one in which a single substance is both oxidised and reduced.

TOPIC 8 – ACIDS, BASES AND SALTS

PROPERTIES OF ACIDS AND BASES

When a substance dissolves in water, it forms an AQUEOUS SOLUTION shown by the symbol (aq).

Aqueous solutions can be acid, alkaline or neutral.

INDICATORS are used to tell if a solution is acidic, alkaline, basic or neutral.

Indicators can be liquids or even used in a PAPER form. They become different colours with different solutions.

The most common indicator is LITMUS

COLOUR OF LITMUS	TYPE OF SOLUTION
Red	Acidic
Purple	Neutral
blue	Alkaline

Universal indicator (UI) can show the strengths of solutions of acids and alkalis because it has more colours. Each colour is linked to a number on a scale called the pH scale. The range of numbers is from 1 to 14.

THE PH SCALE FOR IGCSE

Concentration of Hydrogen ions compared to distilled water		Examples of solutions at this pH
10,000,000	pH = 0	Battery acid, Strong Hydrofluoric Acid
1,000,000	pH = 1	Hydrochloric acid secreted by stomach lining
100,000	pH = 2	Lemon Juice, Gastric Acid Vinegar
10,000	pH = 3	Grapefruit, Orange Juice, Soda
1,000	pH = 4	Tomato Juice Acid rain
100	pH = 5	Soft drinking water Black Coffee
10	pH = 6	Urine Saliva
1	pH = 7	"Pure" water
1/10	pH = 8	Sea water
1/100	pH = 9	Baking soda
1/1,000	pH = 10	Great Salt Lake Milk of Magnesia
1/10,000	pH = 11	Ammonia solution
1/100,000	pH = 12	Soapy water
1/1,000,000	pH = 13	Bleaches Oven cleaner
1/10,000,000	pH = 14	Liquid drain cleaner

SUMMARY

pH BETWEEN 1 AND 6 = ACIDIC

pH BETWEEN 8 TO 14 = ALKALINE

pH 7 IS NEUTRAL

pH OF 1 TO 4 IS STRONG ACID

pH OF 5 AND 6 = WEAK ACID

pH OF 8 TO 10 = WEAK ALKALI

pH OF 11 to 14 = STRONG ALKALI

WHAT ARE ACIDS?

Acids are substances that contain REPLACEABLE hydrogen ions H^+ . These hydrogen atoms ARE REPLACED in a chemical reaction by METAL IONS. THE CHEMICAL THAT IS MADE IS CALLED A SALT.

Acids only show their properties when they are in aqueous solution. This is because, in water, acids form the hydrogen ions (which are also called PROTONS). These ions are responsible for acid properties. For example, with hydrochloric acid in water:

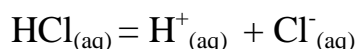

BASICITY is the term used to describe how many hydrogen ions an acid molecule can have replaced. The table shows the basicity of some common acids:

NAME OF ACID	BASICITY OF ACID
Hydrochloric acid HCl	Monobasic (one H^+)
Nitric acid HNO_3	Monobasic (one H^+)
Sulphuric acid H_2SO_4	Dibasic (two H^+)
Phosphoric acid H_3PO_4	Tribasic (three H^+)

WHAT ARE BASES?

Bases are substances that ACCEPT an H^+ ion from an acid in aqueous solution. If a base is soluble in water it is called an ALKALI

AN ALKALI IS A SOLUBLE BASE

Examples of alkalis are sodium hydroxide NaOH and Potassium Hydroxide KOH.

Alkalis produce the HYDROXIDE ION OH^- IN AN AQUEOUS SOLUTION:

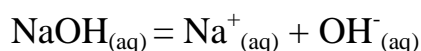

REMEMBER THE FOLLOWING DEFINITIONS

ACIDS ARE PROTON DONATORS

BASES ARE PROTON ACCEPTORS

THE STRENGTH OF ACIDS AND BASES

Acids and bases are described as being ‘strong’ or ‘weak’ depending on the ‘degree of dissociation’ (better known as ionization) in water.

‘Strong’ acids and bases undergo TOTAL 100% IONISATION in water:

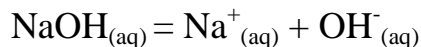
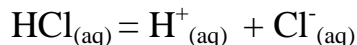

‘Weak’ acids and bases only have PARTIAL DISSOCIATION in water. For example, ethanoic acid (vinegar) CH_3COOH



Another example would be ammonia solution (ammonium hydroxide)



The partial dissociation is the reason WHY AN EQUILIBRIUM SIGN is often used to show these partial dissociation reactions.

‘Weak’ acids with a pH of 4 to 6 and weak bases with a pH of 8 to 10 produce FEWER ions in solution than ‘strong’ acids which have the same concentration. This is why their electrical conductivity is lower than strong acids and bases and also explains their slower reaction rates.

CONTROLLING SOIL ACIDITY

If the soil becomes too acid, then soil acidity can be neutralized using quicklime (calcium oxide). Quicklime is made by heating calcium carbonate in a furnace (oven) at 1200 Celsius.

LIMESTONE = QUICKLIME + CARBON DIOXIDE GAS



When quicklime is added to water, it makes calcium hydroxide $\text{Ca}(\text{OH})_2$ WHICH IS AN ALKALI. This can NEUTRALIZE the acid soil.

Different plants grow in different types of soil. The pH of a soil is an important factor in the growth of some plants. Some plants grow better in acid soils, but most prefer NEUTRAL SOIL. Most plants do not grow at all in an alkali soil.

Adding a fertilizer to the soil can also affect the pH. The soil may have to be treated by adding an acid or an alkali to it. The pH of a soil can be measured by putting a small sample of it into a test tube with distilled water. Then indicator paper or indicator solution is added. The pH can be read from a pH chart.

TYPES OF OXIDE

The OXIDES of elements can be made by heating the element in air or oxygen gas.

Magnesium metal burns in air with a BLINDING WHITE FLASH to form a white powder MAGNESIUM OXIDE.

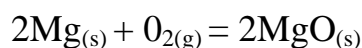

If we add distilled water onto the magnesium oxide powder then test its pH with universal indicator, the solution turns PURPLE.

The oxide is an ALKALINE OXIDE. METAL OXIDES ARE BASIC (OR ALKALINE) OXIDES.

When sulphur burns in oxygen gas, sulphur dioxide gas is formed. If we add universal indicator to this gas in a gas jar, the indicator turns RED.

The oxide is an ACIDIC OXIDE. NON-METAL OXIDES ARE ACIDIC OXIDES.

The oxides of most elements can be classed as acidic oxides or basic oxides. Some elements form neutral oxides. Water for example (can be classed as hydrogen oxide) and is a neutral oxide. Basic oxides that dissolve in water are called alkaline oxides.

Oxides that don't dissolve (are insoluble) in water cannot be identified using the pH of these solutions. For these insoluble oxides, we test to see if they will react with HYDROCHLORIC ACID. If they did, they would be BASIC OXIDES. If they reacted with SODIUM HYDROXIDE ALKALI, they would be ACIDIC OXIDES.

If they don't react with hydrochloric acid or sodium hydroxide they are neutral oxides.

SUMMARY

BASIC OXIDES ARE METAL OXIDES. THEY HAVE GIANT IONIC STRUCTURES. THEY REACT WITH ACIDS IN NEUTRALIZATION.

ACIDIC OXIDES ARE FROM NON-METALS. THEY HAVE SIMPLE MOLECULAR STRUCTURES. THEY REACT WITH BASES OR ALKALIS IN NEUTRALIZATION. THEY DISSOLVE IN WATER TO FORM ACID SOLUTIONS.

AMPHOTERIC OXIDES

These are formed by less reactive metals like zinc, aluminium and lead. They can behave as both an acidic oxide and a basic oxide. They can react with acids and bases.

NEUTRAL OXIDES

These do not react with acids or alkalis. An example of a neutral oxide is NITROGEN MONOXIDE GAS, NO.

MAKING AND PREPARING CHEMICAL SALTS

Salts - Solubilities

(1) Preparation and solubility :

Salts are prepared by reacting an acid with a metal or a base, such as a metal carbonate, hydroxide or oxide.

The acid provides the non-metal ion for the salt, *e.g.* chloride or sulphate or nitrate ions.

The metal or base provides the metal ion for the salt, *e.g.* sodium or copper.

The method used to produce a particular salt depends on two factors -

- (i) the solubility of the base used and
- (ii) the solubility of the salt to be made.

Since all acids are aqueous solutions the acid needed does not directly affect the method of preparation.

The following table summarises the solubilities of the various bases and salts,

compound	metal compound soluble in water	insoluble in water
hydroxide	sodium, potassium, ammonium, calcium	all others
oxide	sodium, potassium, calcium (all dissolve to give hydroxide)	all others
carbonate	sodium, potassium, ammonium	all others
nitrate	all possible	none
sulphate	all others	lead, barium
chloride	all others	silver, lead

There are three main methods of preparing salts -

(i) for a metal or insoluble base reacting with an acid to produce a soluble salt filtration is used, *e.g.* reacting copper(II) oxide with sulphuric acid to make copper(II) sulphate.

(ii) for a soluble base reacting with an acid to produce a soluble salt titration is used, *e.g.* reacting sodium hydroxide with hydrochloric acid to make sodium chloride.

(iii) for an insoluble base reacting with an acid to produce an insoluble salt a two stage process involving filtration and then precipitation is used, *e.g.* reacting lead(II) oxide firstly with nitric acid to produce lead(II) nitrate and then reacting the lead(II) nitrate with aqueous iodide ions to produce lead(II) iodide.

(2) Solubility curves :

A solubility curve is a graph showing the solubility of a particular compound in a solvent at various temperatures.

For example -

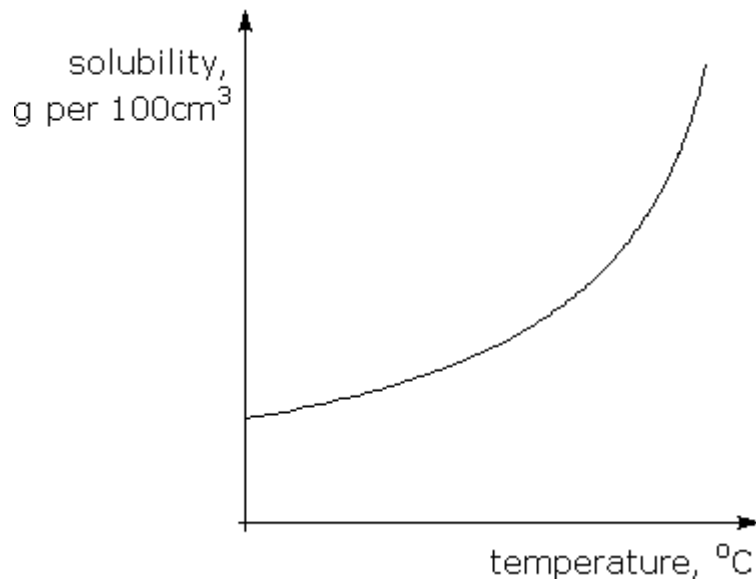

The data for this graph can be gathered by performing a series of experiments at different temperatures.

A beaker of water is heated to the required temperature and an excess of solid is added to the water, with stirring. The excess is filtered off, dried and weighed and the mass dissolved can be calculated by subtraction.

The graph can be used to calculate how much solid is needed to make a saturated solution at a particular temperature.

For example -

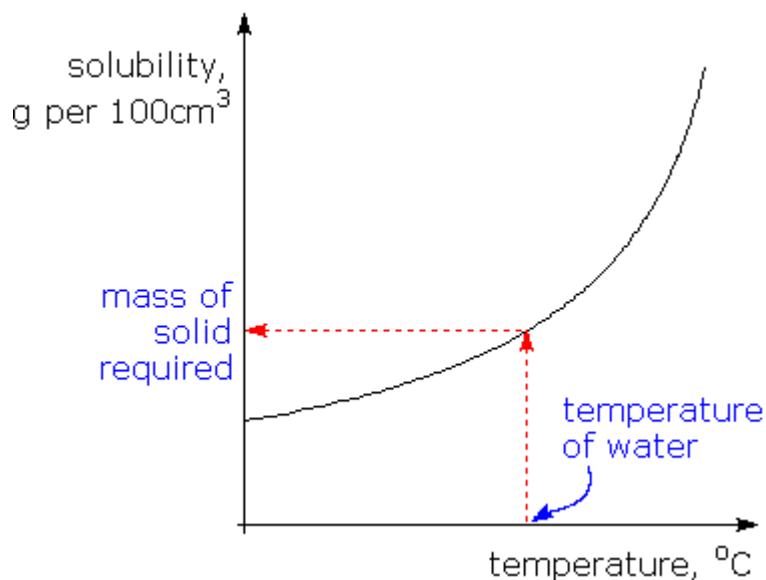

Salts - Preparation of Salts

Experiment 1- Preparation of Copper(II) Sulphate

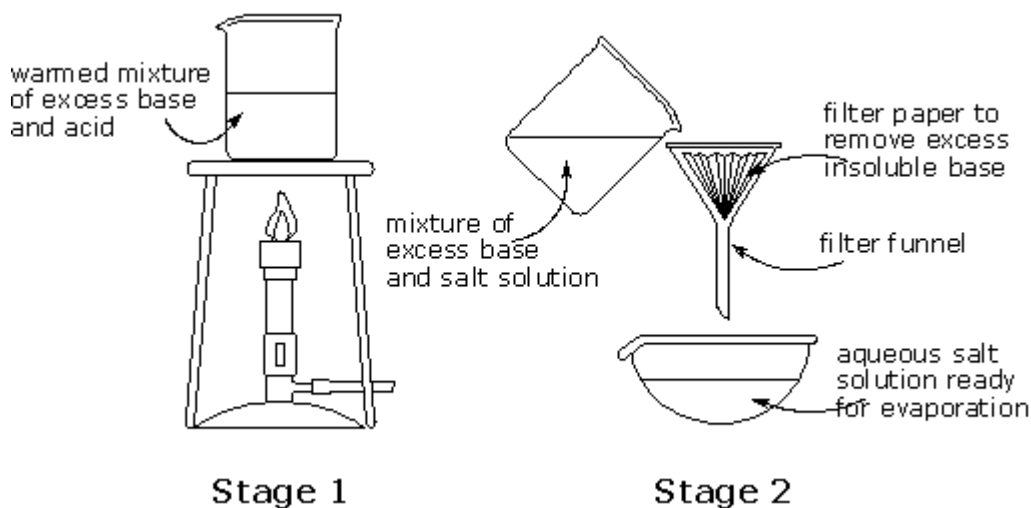

Introduction

There are a number of different methods of making salts, such as the reaction of a metal with an acid. Copper metal, however, does **not** react with sulphuric acid and so another method must be used. In this experiment a basic copper compound (copper(II) oxide) will be reacted with sulphuric acid giving copper(II) sulphate as one of the products.

Method

Place 25 cm³ of dilute sulphuric acid in a 100 cm³ beaker and warm it gently over a Bunsen burner flame to about 50 °C. Add a **small** spatula measure of copper(II) oxide and stir, with a glass rod, until it dissolves. Then add a further spatula measure, with stirring and continue until a small quantity of copper(II) oxide is present in excess (How can you tell the copper(II) oxide is in excess?). Filter off the excess copper(II) oxide, allowing the filtrate to pass into an evaporating basin on a tripod and gauze, and heat it gently until half the liquid has evaporated. Leave the remaining liquid to crystallise.

Questions

- (i) Write up the experiment fully as you do it, being careful to include all observations at the various stages.
- (ii) Write a word and a balanced formula equation for this reaction.
- (iii) How would you go about making copper(II) chloride crystals? Write a balanced formula equation for this reaction.

As shown by the diagrams above, the first stage is the addition of black copper(II) oxide to sulphuric acid. Mild heating is required for a full reaction to occur; however, care must be taken to ensure that the acid does not boil as this would be a great safety hazard.

The copper(II) oxide is added until no more visible reaction can be seen, *i.e.* the base no longer dissolves and a black solid is seen in the **blue** solution.

The mixture is then filtered (stage 2 above) to remove the excess black solid and leave a clear **blue** solution in the evaporating bowl. If the blue solution is heated gently, to remove some of the water and allowed to cool down slowly, crystals will appear. The slower this *crystallization* is allowed to occur, the larger the crystals that will be produced

Experiment - Preparation of Sodium Chloride

Introduction

The only method of preparing a water soluble salt from a water soluble base (also called an **alkali**) is to use **titration**. This is where a known volume of base is reacted with an acid using an **indicator**. The indicator shows when the correct volume of acid has been added (**i.e.** when the reaction is fully complete) by **changing colour**.

Method

Using a pipette fitted with a pipette filler, place 25 cm^3 of the sodium hydroxide solution into a 100 cm^3 conical flask. Add a few drops of an indicator, and note the indicator's name as well as the initial colour of the indicator in the alkali. Carefully fill a burette with the hydrochloric acid solution provided to above the zero mark, and run out the excess into a beaker, ensuring the space under the tap is full of acid.

Then run the acid from the burette into the conical flask slowly, making sure to swirl the flask during the addition, until the indicator changes colour **i.e.** all the alkali has reacted. Note the change in colour of the indicator. Note down the volume of acid used to neutralize the 25 cm^3 of sodium hydroxide solution. Repeat this procedure a further two times, or until you have two results that agree closely with one-another (within 0.5 cm^3 of each other).

Now repeat the procedure once more, but omit the indicator from the conical flask containing the sodium hydroxide solution. Add the correct volume of hydrochloric acid from the burette. This will give a clear colourless solution containing only sodium sulphate dissolved in water. Evaporate some of the liquid using a Bunsen burner and a crystallizing bowl, and leave to crystallize.

Questions

(i) Write up all your observations and results as they occur.

(ii) Write a full balanced chemical equation for this reaction and the reaction of sodium hydroxide with

- a) Sulphuric acid
- b) Nitric acid
- c)

- ***N.B.:*** This method of preparation is used when any and ***all sodium or potassium salts*** are made.
- The problem with the reaction of a soluble base reaction with acid is that once all the acid has reacted any excess base will not be visible. This problem is overcome by adding a third chemical into the reaction mixture called an ***indicator***.
- Indicators are chemicals that change colour with a ***change in pH***. So, if the indicator is added to an acid it will be one colour. As base is added the pH of the solution is raised until, once all the acid has reacted, ***i.e.*** been neutralized, and the base is now in excess, the indicator changes colour.
- Exemplar indicators -

<i>Indicator</i>	<i>colour in acid</i>	<i>colour in base</i>
phenolphthalein	colourless	purple
methyl orange	red	yellow

- The skill involved in this technique is to add the base to the acid slowly enough so that the indicator just changes colour with one drop of excess base.

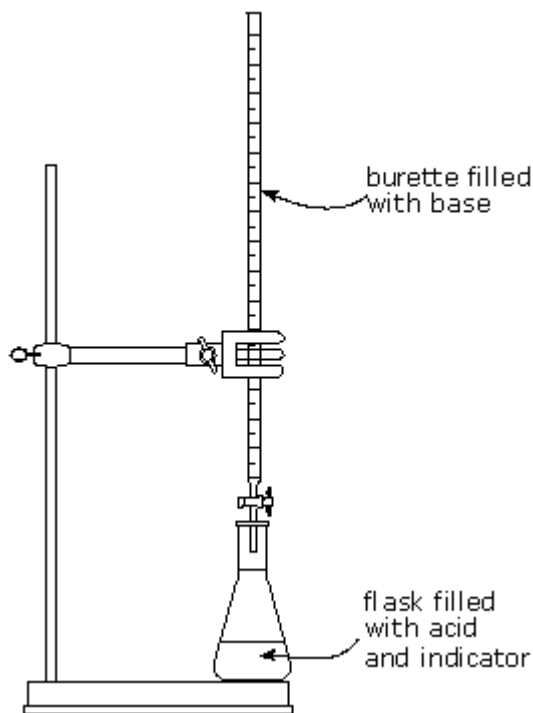

- Specialist glassware is used to allow extreme precision in the volume measurements for this technique. The acid required to begin with is measured using a pipette into a conical flask and a few drops of an indicator is added to the flask.
- A clamp stand is set up with a burette attached, see diagram above, and the burette is filled up with the solution of base.
- The base is added from the burette slowly until the indicator changes colour. The volume of base required can be read from the markings on the side of the burette.
- The experiment can be run a number of times to gain a more accurate average value for the volume of base that needs to be added to neutralise the acid used.
- Once this accurate value has been determined, the experiment can be run one last time without any indicator. The volume of base that is required can be added carefully from the burette to produce a colourless solution, instead of the coloured solutions produced when indicator is added.
- This clear colourless solution can be heated to encourage crystals to form and then left to cool down slowly so that large crystals can form.

Experiment - Preparation of Lead(II) Iodide

Introduction

Another method of preparing salts depends on the solubility of certain salts. Salts that are insoluble in water can be prepared by a **precipitation** method. That is when two clear liquids are mixed together and a reaction between them gives a solid precipitate, insoluble in water. An example of this process is the preparation of lead iodide, method below.

Method

Place 50 cm³ of dilute nitric acid in a 100 ml beaker and warm it gently over a Bunsen burner, on a tripod and gauze, to about 50°C. **DO NOT BOIL THE ACID.** Remove the beaker containing the acid from the tripod, and add small spatula measures of lead(II) oxide, PbO, stirring constantly, until no more will dissolve. Allow the solution to cool. Filter off the excess lead(II) oxide and allow the filtrate (the aqueous solution) to pass into a clean conical flask.

Take about half the filtrate (the liquid filtered through the funnel) and evaporate some of the water off, as with the preparation of copper(II) sulphate crystals before.

To the other 25 cm³ of the solution add an equal volume of dilute potassium iodide_(aq), KI. Filter off the solid lead(II) iodide produced. Wash the residue with distilled water and leave it to dry.

Questions

- (i) Write up all your method and observations as they occur in your reaction.
- (ii) Why cannot lead iodide be prepared by the reaction of
 - (a) lead metal with dilute hydroiodic acid?
 - (b) lead carbonate with dilute hydroiodic acid?
- (iii) What is the intermediate lead compound formed in this reaction?

There is no direct method of preparing an insoluble salt from an insoluble base. The problem is that as the base is added the salt is produced so filtration would yield a mixture of two solids. Titration won't work either as the base is not soluble in water.

Using the preparation of lead(II) iodide as an example, the solution is a two stage process. The first stage is the same as the method for making copper(II) sulphate (shown above). Lead(II) oxide is added to hot nitric acid and when an excess of oxide is present the mixture is filtered.

This gives a filtrate of lead(II) nitrate solution. An equal volume of potassium iodide solution is then added and the resulting mixture filtered to give solid lead(II) iodide as the residue.

ION TESTS

THIS SECTION IS VITALLY IMPORTANT AND CAN BE UP TO 15 MARKS ON A PAPER 6 ALTERNATIVE TO PRACTICAL PAPER WHICH IS TAKEN BY BOTH CORE AND EXTENDED STUDENTS

Experiment - Tests on Inorganic Ions

Introduction

You are provided with a series of labeled aqueous solutions containing various **cations** (**positive ions**) and **anions** (**negative ions**) as well as sodium hydroxide_(aq), ammonium hydroxide_(aq), silver nitrate_(aq), lead nitrate_(aq), barium chloride_(aq), hydrochloric acid_(aq), nitric acid_(aq) and Devarda's alloy. Perform the reactions as detailed below in stages 1, 2 and 3 completing the tables where appropriate.

Method - Stage 1

Take 2 test tubes and pipette one of the cation solutions into each of the test tubes, to a depth of about 1 cm.

To one of the test tubes add 5 drops of sodium hydroxide_(aq) from the bottles in the lab. Note all observations in the table below.

Then fill the tube up to a depth of about 5 cm with the sodium hydroxide_(aq) and again note your observations down in the table.

Then repeat the above procedure in the second test tube, but use ammonium hydroxide_(aq) in place of the sodium hydroxide_(aq).

Cation	Addition of 5 drops of sodium hydroxide	Addition of excess sodium hydroxide	Addition of 5 drops of ammonium	Addition of excess ammonium
Calcium(II)				
Zinc(II)				
Aluminium(III)				
Iron(II)				
Iron(III)				
Copper(II)				

Stage 2

As a revision exercise perform the tests for various anions as detailed in the table below. Complete the observations for the table.

Anion	Test procedure	Observations
Chloride	To a test tube add 1 cm depth of the solution. Then add 5 drops of nitric acid followed by 5 drops of silver nitrate solution	
Iodide	To a test tube add 1 cm depth of the solution. Then add 5 drops of nitric acid followed by 5 drops of lead(II) nitrate solution	
Sulphate	To a test tube add 1 cm depth of the solution. Then add 5 drops of hydrochloric acid followed by 5 drops of barium chloride solution	
Nitrate	To a test tube add 1 cm depth of the solution. Then add 1 cm of sodium hydroxide(aq) followed by a spatula tip of Devarda's alloy. Heat the mixture gently and test with damp red litmus paper.	

Stage 3

The final part of the practical work involves the use of all the observations you have made so far.

There are 3 solutions labelled **X**, **Y** and **Z** in the laboratory. Each of them contains one cation and two anions. To find out what the components of each solution perform the following routine.

Take 6 test tubes and pipette about a cm depth of one of the unknown solutions into each of them. To one of the test tubes perform the sodium hydroxide_(aq) test from stage 1 and note down your observations in a suitable table. To the second tube perform the ammonium hydroxide_(aq) test from stage 1. In the remaining test tubes perform the various anion tests and again note down all positive and negative observations.

From your observations in stages 1 and 2 try to determine the composition of the solution and then repeat for the other unknown solutions.

DETAILED NOTES ON ION TESTS

(1) Metal ions :

When metal ions are reacted with hydroxide ions a displacement reaction generally occurs, since most metal hydroxides are insoluble in water. Group I hydroxides, *e.g.* sodium hydroxide, are all soluble in water and so if a solution of sodium hydroxide is mixed with a solution of another metal ion a precipitate is formed.

The transition metal hydroxides produced tend to be uniquely coloured and so they allow easy identification of the particular metal ion that is present, *e.g.* iron(II) hydroxide is **green**, iron(III) hydroxide is **red** and copper(II) hydroxide is **blue**.

Below is a table summarizing the precipitates formed with common IGCSE metal ions -

<i>Cation</i>	<i>Reaction with NaOH_(aq)</i>	<i>Reaction with NH₄OH_(aq)</i>
aluminium, Al ³⁺ _(aq)	white precipitate, soluble in excess	white precipitate, insoluble in excess
ammonium, NH ₄ ⁺ _(aq)	ammonia (SMELL !) produced on heating	
calcium, Ca ²⁺ _(aq)	white precipitate, insoluble in excess	no precipitate
copper, Cu ²⁺ _(aq)	light blue precipitate, insoluble in excess	light blue precipitate, soluble in excess giving a dark blue solution
iron(II), Fe ²⁺ _(aq)	green precipitate, insoluble in excess	green precipitate, insoluble in excess
iron(III), Fe ³⁺ _(aq)	red-brown precipitate, insoluble in excess	red-brown precipitate, insoluble in excess
zinc, Zn ²⁺ _(aq)	white precipitate, soluble in excess	white precipitate, soluble in excess

Exemplar equation -



These equations can also be represented only by the reacting ions, simplifying the equation -



As can be seen in the table above if ammonium hydroxide, NH_4OH , is used instead of sodium hydroxide some differences occur. Ammonium hydroxide is a weaker base than sodium hydroxide, *i.e.* there are fewer hydroxide ions in solution.

For calcium ions this means that there aren't enough hydroxide ions to form any calcium hydroxide, so no precipitate is seen.

The addition of excess hydroxide ions allows more differentiation between ions, such as aluminium and zinc. Normally hydroxides are bases, *i.e.* they react only with acids; however, some metal hydroxides are *amphoteric*, *i.e.* they react with both acids and bases. This is the case with aluminium hydroxide and zinc hydroxide. If excess sodium hydroxide is added to the precipitate a reaction occurs that forms a soluble product.

Exemplar equation -

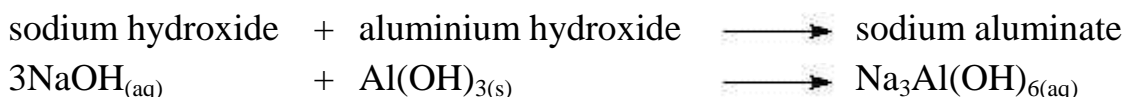

Ammonium hydroxide is too weak a base to allow this reaction to occur, so the aluminium hydroxide does not dissolve in excess ammonium hydroxide.

With zinc hydroxide and copper(II) hydroxide the precipitates do dissolve in excess ammonium hydroxide, not because of an acid-base reaction, but because the molecules of ammonia surround the metal ions in solution, making them soluble.

(2) Non-metal ions :

There is no particular pattern for testing non-metal ions. The halide ions, chloride, bromide and iodide, are tested for by adding nitric acid followed by aqueous silver nitrate and noticing the colour of the precipitate formed (see halogens in junior part).

Carbonate ions react with acids to liberate carbon dioxide gas, which can be tested for by passing the gas through limewater.

Sulphate ions will undergo a displacement reaction when added to acidified aqueous barium chloride, BaCl_2 . A white precipitate of barium sulphate is formed.

Ammonium ions are also non-metal ions and are tested for by warming the ammonium compound with aqueous sodium hydroxide, or some other strong base. This produces ammonia gas, which can be tested for by placing **damp** red litmus paper in the gas. If it turns blue then a basic gas has been given off and that must be ammonia.

Exemplar ionic equation -

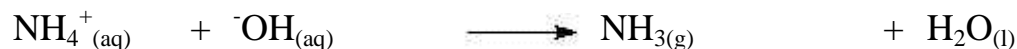

Below is a table summarizing the observations for the common non-metal ion tests -

Anion	Reaction
carbonate, $\text{CO}_3^{2-}_{(\text{aq})}$	CO_2 liberated when reacted with dilute acids
chloride, $\text{Cl}^-_{(\text{aq})}$	gives white precipitate with acidified silver nitrate, $\text{AgNO}_3_{(\text{aq})}$
iodide, $\text{I}^-_{(\text{aq})}$	gives yellow precipitate with acidified lead nitrate, $\text{Pb}(\text{NO}_3)_2_{(\text{aq})}$
nitrate, $\text{NO}_3^-_{(\text{aq})}$	ammonia, NH_3 , liberated on heating with $\text{NaOH}_{(\text{aq})}$ and Al foil (see tests on <u>ammonia gas</u> below)
sulphate, $\text{SO}_4^{2-}_{(\text{aq})}$	gives white precipitate with acidified barium chloride, $\text{BaCl}_2_{(\text{aq})}$

(3) Gases :

Below is a table summarizing the various gas tests encountered in GCSE -

<i>Gas</i>	<i>Test</i>
ammonia, NH_3	turns damp red litmus paper blue (+ <i>SMELL !</i>)
carbon dioxide, CO_2	gives a white precipitate with limewater
chlorine, Cl_2	bleaches damp litmus paper
hydrogen, H_2	explodes with a 'pop' with a lighted splint
oxygen, O_2	relights a glowing splint

TOPIC 9 – THE PERIODIC TABLE

SUMMARY OF FAMILIES IN PERIODIC TABLE

Group	1	2	3	4	5	6	7	8	9	10	11	12	13	14	15	16	17	18	
Period 1	1																	2	
1	H																		He
2	3	4												5	6	7	8	9	10
2	Li	Be												B	C	N	O	F	Ne
3	11	12												13	14	15	16	17	18
3	Na	Mg												Al	Si	P	S	Cl	Ar
4	19	20	21	22	23	24	25	26	27	28	29	30	31	32	33	34	35	36	
4	K	Ca	Sc	Ti	V	Cr	Mn	Fe	Co	Ni	Cu	Zn	Ga	Ge	As	Se	Br	Kr	
5	37	38	39	40	41	42	43	44	45	46	47	48	49	50	51	52	53	54	
5	Rb	Sr	Y	Zr	Nb	Mo	Tc	Ru	Rh	Pd	Ag	Cd	In	Sn	Sb	Te	I	Xe	
6	55	56	57*	72	73	74	75	76	77	78	79	80	81	82	83	84	85	86	
6	Cs	Ba	La	Hf	Ta	W	Re	Os	Ir	Pt	Au	Hg	Tl	Pb	Bi	Po	At	Rn	
7	87	88	89**	104	105	106	107	108	109	110	111	112		114		116		118	
7	Fr	Ra	Ac	Rf	Db	Sg	Bh	Hs	Mt	Uun	Uuu	Uub		Uuq		Uuh		Uuo	

*Lanthanides	58	59	60	61	62	63	64	65	66	67	68	69	70	71
	Ce	Pr	Nd	Pm	Sm	Eu	Gd	Tb	Dy	Ho	Er	Tm	Yb	Lu
**Actinides	90	91	92	93	94	95	96	97	98	99	100	101	102	103
	Th	Pa	U	Np	Pu	Am	Cm	Bk	Cf	Es	Fm	Md	No	Lr

The modern periodic table, based on atomic number and electron configuration, was created primarily by a Russian chemist, Dmitri Ivanovich Mendeleev, and a German physicist, Julius Lothar Meyer, both working independently. They both created similar periodic tables only a few months apart in 1869.

Mendeleev created the first periodic table based on atomic weight. He observed that many elements had similar properties, and that they occur periodically. Hence, the table's name.

His periodic law states that the chemical and physical properties of the elements vary in a periodic way with their atomic weights. The modern one states that the properties vary with atomic number, not weight.

Elements in Mendeleev's table were arranged in rows called periods. The columns were called groups. Elements of each group had similar properties.

The Periodic table can be divided into nine families of elements each having similar properties. The families include:

Alkali metals

The alkali metals, found in group 1 of the periodic table, are highly reactive metals that do not occur freely in nature. These metals have only one electron in their outer shell. Therefore, they are ready to lose that one electron in ionic bonding with other elements. As with all metals, the alkali metals are malleable, ductile, and are good conductors of heat and electricity. The alkali metals are softer than most other metals.

Alkaline metals

The alkaline earth elements are metallic elements found in the second group of the periodic table. All alkaline earth elements have an oxidation number of +2, making them very reactive.

The Transition metals

The 38 elements in groups 3 through 12 of the periodic table are called "transition metals." As with all metals, the transition elements are both ductile and malleable, and conduct electricity and heat. Their valence electrons are present in more than one shell. This is why they often exhibit several common oxidation states.

Other metals

The "other metals" elements are located in groups 3, 4, 5, 6. While these elements are ductile and malleable, they are not the same as the transition elements. These elements, unlike the transition elements, do not exhibit variable oxidation states, and their valence electrons are only present in their outer shell. All of these elements are solid, have a relatively high density, and are opaque. They have oxidation numbers of +3, ±4, and -3.

Metalloids

Metalloids are the elements found between the boundary that distinguishes metals from non-metals. Metalloids have properties of both metals and non-metals. Some of the metalloids, such as silicon and germanium, are semi-conductors.

Non-metals

Non-metals are the elements in groups 3 to 8 of the periodic table. Non-metals are not able to conduct electricity or heat very well. As opposed to metals, non-metallic elements are very brittle. The non-metals can be gases, such as oxygen and solids, such as carbon. The non-metals have no metallic luster, and do not reflect light. They have oxidation numbers of ± 4 , -3 , and -2 .

Halogens

The halogens are five non-metallic elements found in group 7 of the periodic table. All halogens have 7 electrons in their outer shells, giving them an oxidation number of -1 .

Noble gases

The noble gases are found in group 8 of the periodic table. These elements have an oxidation number of 0. This prevents them from forming compounds readily. All noble gases have 8 electrons in their outer shell, making them stable.

Rare Earth

The 30 rare earth elements are composed of the lanthanide and actinide series. One element of the lanthanide series and most of the elements in the actinide series are synthetic, that is, human-made. All of the rare earth metals are found in group 3 of the periodic table, and the 6th and 7th periods.

CLASSIFICATION OF ELEMENTS IN THE PERIODIC TABLE

Elements are the building blocks of chemistry. All matter in the universe is made from elements. An element is made from only one type of atom and cannot be split up into a simpler substance. Over 100 elements have now been discovered and each has its own properties and reactions. In the periodic table, elements with similar properties and similar chemical reactions are put close together.

THE PERIODIC TABLE ARRANGES ELEMENTS IN ORDER OF INCREASING ATOMIC NUMBER.

ALL ATOMS ARE NEUTRAL. THE ATOMIC NUMBER ALSO TELLS US THE NUMBER OF ELECTRONS IN EACH ELEMENT.

The elements are then arranged in vertical columns called **GROUPS** and horizontal rows called **PERIODS**.

PERIODS

Rows of elements are arranged in increasing atomic number from left to right. These are called **PERIODS**. There are 7 rows and 7 periods in the periodic table.

As we go across each period (row), each successive atom has one more proton and one more electron (in the same outer shell or orbit). The number of neutrons also increases but **NOT** always by one.

Let us look across the periodic table from sodium to argon.

NAME OF ELEMENT	GROUP	ELECTRON ARRANGEMENT
SODIUM	1	2.8.
MAGNESIUM	2	2.8.2
ALUMINIUM	3	2.8.3
SILICON	4	2.8.4
PHOSPHORUS	5	2.8.5
SULPHUR	6	2.8.6
CHLORINE	7	2.8.7
ARGON	8	2.8.8

THE LAST NUMBER IN THE ELECTRON CONFIGURATION FOR ELEMENTS 3 TO 20 IS THE SAME AS THE GROUP NUMBER OF THE ELEMENT IN THE PERIODIC TABLE.

As we go across a period, the following patterns (**TRENDS**) take place:

1. Metals on the left going across to non-metals on the right
2. Group 1 elements are the most reactive metal group. Group 4 elements are least reactive. Groups 5 to 7 get more reactive (group 7 being most reactive non-metal group called the halogens). Group 8 is unreactive.

The first period contains only 2 elements hydrogen and helium. We don't usually study this period. Hydrogen is a very reactive gas. Helium is an unreactive gas but is placed into group 8 as it has a FULL OUTER SHELL OF ELECTRONS.

The elements in the middle block of the periodic table in periods 4,5 and 6 are called TRANSITION METALS. One of the typical properties of transition metals is that their compounds are catalysts and speed up the rate of a chemical reaction by providing an alternative pathway to a reaction by providing it with a lower activation energy.

Vanadium (V) oxide is used in the Contact Process to manufacture sulphuric acid. Iron powder is used in the Haber Process to manufacture ammonia.

GROUPS

Columns containing elements with an atomic number increasing down the column are called groups. The groups are numbered 1 to 8.

Elements in a group have similar properties. You can think of them as a chemical family.

Groups have 'family names' such as

Group 1 = alkali metals; Group 2 = alkaline earth metals; Group 7 = halogens;
Group 8 = noble gases

IN THE SAME GROUP, ELEMENTS HAVE THE SAME NUMBER OF OUTER SHELL ELECTRONS AND HAVE THE SAME CHEMICAL PROPERTIES

METALS AND NON-METALS

Most elements can be classed as either metals or non-metals. In the periodic table, metals are found to the left and middle block. Non-metals are found on the right.

METALLOID elements are between metals and non-metals. They have some properties of metals and some properties of non-metals. Examples of metalloids are silicon and germanium. They are often called SEMICONDUCTORS and are used as computer microchips.

GROUP PROPERTIES

MOST ELEMENTS ARE METALS. SOME METALS ARE VERY HIGHLY REACTIVE WHILST OTHERS ARE COMPARATIVELY UNREACTIVE. THE TWO TYPES OF METALS ARE FOUND IN DIFFERENT PARTS OF THE PERIODIC TABLE.

GROUP 1 ELEMENTS– THE ALKALI METALS

These very reactive metals only have one outer shell electron. This electron is given away and donated when the metal reacts with a non-metal in ionic bonding. The more electrons a metal atom has to lose in a reaction, the more energy is needed to start the chemical reaction.

This is why group 2 elements are less reactive. They have to lose two electrons when they react with a non-metal to form an ionic bond.

REACTIVITY INCREASES DOWN THE GROUP. As the atoms get bigger, the outer electrons are far away from the magnetic pull of the nucleus. They can be removed more easily. The atoms react and form **CATIONS – POSITIVE IONS THAT ARE ATTRACTED TO THE NEGATIVE CATHODE IN ELECTROLYSIS.**

PROPERTIES OF GROUP 1 METALS

1. SOFT
2. EASY TO CUT
3. SHINY WHEN CUT BUT QUICKLY GO DARK (TARNISH) IN AIR
4. VERY LOW MELTING POINTS COMPARED TO MOST OTHER METALS. SODIUM MELTS AT 98 CELSIUS, POTASSIUM AT 63 CELSIUS.
5. VERY LOW DENSITIES COMPARED TO MOST OTHER METALS. LITHIUM, SODIUM AND POTASSIUM FLOAT ON WATER.
6. REACT VERY EASILY WITH AIR, WATER AND HALOGENS. THE ALKALI METALS ARE STORED IN OIL TO STOP THEM REACTING WITH AIR AND WATER.

GROUP 1 METALS WITH AIR OR OXYGEN

The metals are stored in oil to stop a violent reaction.

The metals burn easily and give off coloured flames. Lithium forms a red flame, sodium a yellow/orange flame. Potassium forms a lilac flame.

A white solid is formed each time called either lithium oxide, sodium oxide or potassium oxide.

Here are the equations for the reactions

Lithium + oxygen = lithium oxide

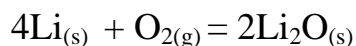

Sodium + oxygen = sodium oxide

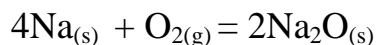

Potassium + oxygen = potassium oxide

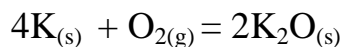

GROUP 1 METALS IN WATER

The metals react vigorously. They float on the surface. They move rapidly on the surface. The heat of the reaction melts the metal so it forms a spinning ball. Bubbles of hydrogen gas are give off and the metal 'disappears'. With the more reactive metals like sodium or potassium, the hydrogen gas burns. The resulting solution is a group 1 metal hydroxide. Adding universal indicator turns it dark purple – pH 14.

Lithium + water = lithium hydroxide solution + hydrogen gas

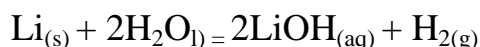

sodium + water = sodium hydroxide solution + hydrogen gas

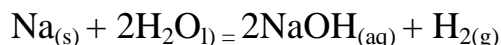

potassium + water = potassium hydroxide solution + hydrogen gas

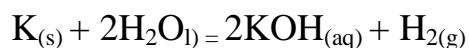

GROUP 1 METALS + CHLORINE GAS

The metals react extremely easily burning in chloride to form a white solid called lithium chloride, sodium chloride or potassium chloride.

Lithium + chlorine gas = lithium chloride

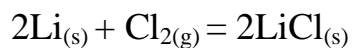

sodium + chlorine gas = sodium chloride

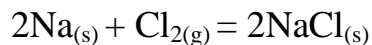

potassium + chlorine gas = potassium chloride

NO PICTURE AVAILABLE – FAR TOO VIOLENT!

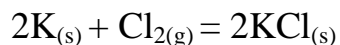

USES OF GROUP 1 METALS

Lithium carbonate = light sensitive Polaroid sunglasses lenses

Lithium hydroxide = CO₂ remover in air conditioning systems

Sodium chloride = table salt

Sodium carbonate = water softener

Sodium hydroxide = oven cleaner and paper making

Monosodium glutamate = flavour enhancer in cooking

Sodium sulphite = food preservative, smoky flavor

Potassium nitrate = fertilizer and explosives

GROUP 7 ELEMENTS – THE HALOGENS

The term halogens means ‘maker of salts’. The halogens react with most metals to form salts. The halogens **have 7 outer shell electrons**. This makes them very reactive. During ionic bonding, the halogens react with a metal and accept one extra electron to make a complete full outer electron shell.

THE REACTIVITY OF HALOGENS DECREASES DOWN THE GROUP.

FLUORINE IS MOST REACTIVE, IODINE IS LEAST REACTIVE.

The reactivity decreases down the group because as the atoms get bigger, an electron in the outer shell becomes further away from the nucleus as down the group, the number of electron shells also increases.

Fluorine is a pale yellow gas, chlorine is a pale green gas, bromine is a brown liquid and iodine is a black solid or purple gas.

All group 7 elements have 7 outer shell electrons. All exist as molecules containing 2 atoms. They are DIATOMIC MOLECULES F_2 , Cl_2 , Br_2 , I_2 .

HALOGENS IN WATER

The halogens dissolve in water and also react with it. They form solutions that behave as bleaches. Chlorine solution is pale yellow, bromine solution is brown, iodine solution is brown.

Chlorine + water = hydrochloric acid + chloric (I) acid



HALOGENS WITH METALS

The halogens will form salts with all metals. For example, gold leaf (gold is a very unreactive metal) will catch fire in chlorine gas even without heating. With a metal such as iron, brown fumes of iron (III) chloride form.

Iron + chlorine gas = Iron (III) chloride

$2Fe_{(s)} + 3Cl_{2(g)} = 2FeCl_{3(s)}$ Fluorine forms salts called fluorides, chlorine forms salts called chlorides, bromine forms salts called bromides and iodine forms salt called iodides.

DISPLACEMENT REACTIONS OF HALOGENS

A MORE REACTIVE HALOGEN WILL DISPLACE A LESS REACTIVE HALOGEN FROM A SOLUTION OF A SALT.

Chlorine displaces bromine from a solution of sodium bromide solution.

Order of displacement is fluorine then chlorine then bromine then iodine.

Chlorine + sodium bromide = sodium chloride + bromine

Pale green solution + clear solution = clear solution + orange solution

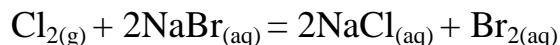

The colourless solution (sodium bromide) will turn brown as the chlorine is added because of the formation OF BROMINE BY THE DISPLACEMENT REACTION.

Chlorine displaces iodine from sodium iodide solution.

Chlorine + sodium iodide = sodium chloride + iodine

Pale green solution + clear solution = clear solution + brown solution

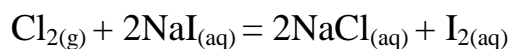

The colourless solution will turn brown as the chlorine is added due to the formation of iodine.

The displacement reactions above are examples of REDOX REACTIONS. Oxidation and reduction takes places at the same time

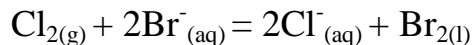

This equation can be written as 2 half –equations showing the involvement of the electrons

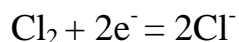

The chlorine is REDUCED by getting extra electrons from the bromide ions



The bromide ions are OXIDISED by losing electrons to the chlorine.

USES OF HALOGENS

Fluorides are used in toothpaste to prevent tooth decay

Fluoride compounds make plastics like TEFLON which is non-stick pan base

Chlorofluorocarbons (CFC'S) – propellants in aerosols and refrigerants

Chlorine is a bleach

Chlorine compounds are used to kill germs in water and swimming pools. They are also used as disinfectants (like Dettol) and antiseptics like TCP.

Hydrochloric acid is widely used in industry to make chloride compounds

Bromine compounds make pesticides like cockroach killer

Silver bromide is the light sensitive film coating on photographic film

Iodine solution is an antiseptic in hospitals before you have an operation

PREDICTING PROPERTIES OF ELEMENTS

Metallic elements are on the left of the periodic table. Non-metallic elements are on the right of the periodic table. In the middle is group 4 – a mixture of metal and non-metal elements.

As you go down any group, the properties change as the ATOMS GET LARGER. More electron shells exist and there are more protons and neutrons in the nucleus. The ATOMIC RADIUS of the atom increases as the RADIUS from the centre of the nucleus to the outer shell electrons INCREASES.

As you go down a group of metals, the elements become more reactive as the atoms get larger. In Group 1, lithium is least reactive and potassium is most reactive. Francium is actually the most reactive as it is radioactive. We are not allowed to keep rubidium, caesium and francium in schools.

Metallic elements lose electrons when they react. The larger atoms lose electrons more easily than smaller ones because in smaller atoms, the outer electrons are closer to the pull of the central nucleus. The easier it is for a metallic element to lose its electrons, the MORE reactive it is.

As you go down a non-metallic element group like group 7, the elements are LESS REACTIVE as the atoms get larger. In group 7, fluorine is the MOST REACTIVE element.

Fluorine is the most reactive non-metal element in the periodic table.

Non-metallic elements GAIN electrons when they react. The smaller atoms nearer the top of the group do not have the attractive pull of the protons reduced by the larger number of electron shells between them and the nucleus.

TRENDS IN OTHER GROUPS

The trend in INCREASING REACTIVITY down a metallic group is the same in groups 1,2 and 3. These groups are also mainly metallic groups.

The trend in decreasing reactivity down a non-metallic group like group 7 is the same for groups 5,6 and 7 which are also mainly non-metallic.

Group 4 shows a change from metallic properties to non-metallic properties as you go down the group

C CARBON IS NON-METAL

Si SILICON IS NON-METAL

Ge GERMANIUM IS METALLOID

Sn TIN IS METAL

Pb LEAD IS METAL

‘Metalloid’ means that sometimes germanium behaves like a metal and sometimes it behaves like a non-metal.

RULES FOR PREDICTING TRENDS

**AS YOU GO DOWN A GROUP, METALLIC CHARACTER INCREASES.
AS YOU GO UP A GROUP, NON-METALLIC CHARACTER INCREASES.**

TRANSITION ELEMENTS

These elements are found in the centre of the periodic table. All transition elements have MORE THAN ONE electron in their outer shell. They are MUCH LESS REACTIVE than group 1 and 2 elements so are the 'everyday' metals. They have much higher melting points and densities. They react much more slowly with water and air/oxygen.

They are widely used as CONSTRUCTION METALS like iron. They are often used as CATALYSTS in the chemical industry.

PROPERTY	GROUP 1 METAL	TRANSITION METAL
Melting point	Low	High
Density	Low	High
Colours of compounds	White	Coloured
Reactions with air/water	Very fast	Slow or no reaction
Reactions with acid	Violent and dangerous	Slow or no reaction

Transition metals have more than one oxidation state. Copper forms Cu^+ and Cu^{2+} ions. We give names to these as copper (I) and copper (II) ions.

This is why CuO is called copper (II) oxide and Cu_2O is copper (I) oxide.

Iron forms Fe^{2+} and Fe^{3+} ions.

This is why FeO is called iron (II) oxide and Fe_2O_3 is iron (III) oxide.

TRANSITION METAL COMPOUNDS ARE USUALLY COLOURED. Copper compounds are usually blue or green. Iron compounds are green or brown. When sodium hydroxide solution is added to a solution of a transition metal compound, a coloured precipitate of the metal hydroxide is formed. The colour of the precipitate helps you to identify the transition metal that is present. For example:

Copper sulphate + sodium hydroxide = copper (II) hydroxide + sodium sulphate

Blue solution + clear solution = blue solution + clear solution

COLOUR OR METAL HYDROXIDE	LIKELY METAL PRESENT
Blue	Copper (II) Cu^{2+}
Green	Nickel (II) Ni^{2+}
Green turning to brown	Iron (II) Fe^{2+}
Orange/brown	Iron (III) Fe^{3+}

Transition metal compounds and other metal compounds produce characteristic flame colours in flame tests

METAL ION	FLAME COLOUR
Lithium	Red
Sodium	Orange/yellow
Potassium	Lilac (pale pink)
Copper	Blue/green
Calcium	Brick red
Strontium	Crimson (intense dark red)
Barium	Apple green

GROUP 8 NOBLE GASES

This is a group of very unreactive non-metal elements. They used to be called the INERT GASES but NO LONGER AS THIS IS INACCURATE AS XENON COMPOUNDS HAVE BEEN DISCOVERED.

WE MUST NOW CALL GROUP 8 THE NOBLE GASES

As far as IGCSE work is concerned though, THEY ARE TOTALLY UNREACTIVE.

They are so unreactive as they have a COMPLETELY FULL OUTER SHELL OF ELECTRONS. They do NOT need to lose electrons like metals do or gain electrons like non-metals do. They are STABLE.

Helium is used in weather balloons, neon is used in coloured lights, argon is the gas used inside a lightbulb, krypton and xenon are used as lasers.

TOPIC 10 – METALS

THERE ARE 42 KEY WORDS TO LEARN IN THIS TOPIC

	KEYWORD	
1	Ore	A rock that contains a source of metal
2	Compounds	Metals found in ores are usually found in _____
3	Mineral	Any Solid in the Earth's crust
4	Oxides	The compounds that metals in ores are most often found in are _____
5	Native Metals	Metals found in their pure form as the Metals themselves
6	Gold, Silver	Examples of Native Metals (2)
7	Native Metals	Gold and Silver are _____
8	Extraction	Removal of a metal from its compound
9	Chemical, Electrical	Two methods of extraction
10	Displacement	When a more reactive element replaces a less reactive element in a compound
11	Reduction	Oxygen removed or Electrons gained
12	Electrolysis	Method of extracting reactive metals (Potassium, Sodium, Calcium, Magnesium, Aluminum)
13	Reduction	Method of extracting less-reactive metals (zinc, Iron, tin, lead)
14	Carbon	Element used in reduction
15	Blast Furnace	Iron is produced in a _____
16	iron oxide + carbon monoxide > iron + carbon dioxide	Word Equation of reduction reaction in iron
17	$2\text{Fe}_2\text{O}_3 + 3\text{C} \rightarrow 4\text{Fe} + 3\text{CO}_2$	Equation of reduction reaction in iron
18	Iron ore (haematite)	A compound that contains iron
19	Iron oxide	Found in Iron Ore
20	Coke	Burns in air to produce heat, and reacts to form carbon monoxide
21	Carbon	Found in Coke
22	Carbon monoxide	Formed when Coke burns in the air to produce heat
23	Limestone	Helps to remove acidic impurities from the iron by reacting with them
24	Slag	Produced when Limestone reacts with the impurities in iron
25	Calcium Carbonate	Found in Limestone

26	Too soft	Problem with pure iron
27	Aranged in a regular way	Reason Pure iron is too soft
28	Alloy	When metals are added to another metal to change it's properties.
29	Carbon	Type of Steel that is cheap, strong but brittle
30	Nickel	Type of Steel that is resistent to stretching forces
31	Tungsten	Type of Steel that withstands lots of heat
32	Chromium-Nickel	Type of Steel that doesn't rust
33	Smart-Alloys	Metals that keep their shape
34	Transition metal	Metals in the middle of the periodic table
35	Smelting	Elec, The process of heating an ore to extract a metal
36	Electrolysis	Using a current to break down a substence made of ions into simple substances
37	Electrolyte	Substance broken down by electrolysis
38	Cathode	Negative electrode
39	Anode	Positive electrode
40	Al ₂ O ₃	Chemical Formulae of protective layer on Aluminium
41	Low Density, Oxide Layers	Unique properties of Aluminium and Titanium (2)
42	$2(\text{Al}_2\text{O}_3) > 4\text{Al} + 3\text{O}_2$	Equation showing alumina being decomposed through electrolysis

METALS AND ORES

The Earth's crust is composed of a vast number of different compounds, containing both metal and non-metal elements, called **ores**. Some elements are present in greater amounts than others, and they all have a finite limit, *i.e.* when we have mined all there is no more will be available.

Here is a table showing the percentage abundance of some of the most common elements,

metal element	% abundance	non-metal element	% abundance
C		O	
Fe		N	
Ca		Cl	
Al			
Si			

Metal elements are commonly found as metal oxides and the metal itself can be extracted using a one of a variety of chemical reactions. The process of changing the metal ions in a compound to the neutral metal is called **reduction**. At its simplest this means that oxygen has been removed from the compound; however, the term reduction also applies to the addition of electrons to metal ions (see electrolysis in middle part).

The first of the two most common methods of extraction are a reaction with carbon (or carbon monoxide) in a Blast Furnace. This method is used mainly to extract iron from iron oxide ores and zinc from zinc blende.

The other common method of extraction involves passing a great amount of electricity through the molten ore in process called electrolysis.

METALS AND THE REACTIVITY SERIES

Metals such as sodium and potassium (the alkali metals) react violently with water, too violently to do experimentally. The group II metals (also called **alkaline earth** metals) react less readily and can be used in the laboratory.

Whilst magnesium does react with water it reacts so slowly as to be barely noticeable. As with the alkali metals the reactivity of the group II metals increases as the group is descended, with calcium, strontium and barium all reacting at a reasonable rate.

Exemplar equation -

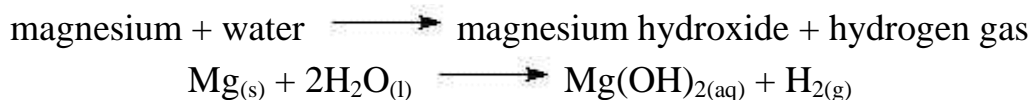

However, if the water is turned into *steam* and passed over the metal the reaction becomes faster. The reaction with metals such as magnesium and zinc becomes noticeable as a white smoke is given off. This smoke is the *metal oxide*, instead of the metal hydroxide formed with water. Hydrogen gas is also produced as with water.

Exemplar equation -

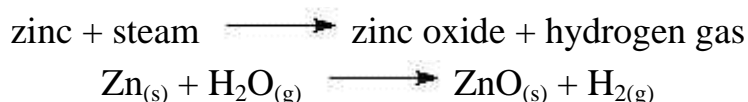

REACTION OF METALS WITH DILUTE HYDROCHLORIC ACID

Metals such as sodium and potassium (the alkali metals) react too violently with dilute acids to do experimentally. Other metals, such as copper, silver and gold, will not react with dilute acids at all. Although a mixture of concentrated hydrochloric and nitric acid, known as **aqua regia**, is powerful enough to form salts with these unreactive metals.

Exemplar equation -

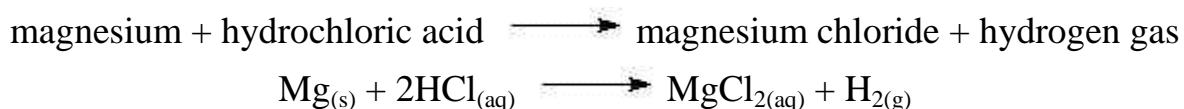

The Reaction of Metals with Hydrochloric Acid

1 Weigh out approximately 0.1 g. of each metal. Place each sample in a separate, labelled boiling tube. Note the state (powder, sheet, block, etc.) and colour of each sample. Record all your observations as you make them

2 Collect a beaker and measure 150 cm³ of dilute hydrochloric acid (the chemical formula is HCl_(aq)) into it.

3 Add sufficient acid to half-fill one of the boiling tubes.

4 Note what happens and record your observations as you make them. Not all the metals will react. If a reaction occurs, record the time taken for the metal to disappear, and test any gas evolved with a lighted splint. If no reaction occurs after one minute, gently warm the mixture over a Bunsen burner flame and record any new observations. Again, test any gases evolved with a lighted splint.

Points to note :

Write up the experiment as you proceed.

Safety spectacles must be worn at all times.

Do **NOT** boil the acid directly over the bunsen burner.

Donot rush the experiment.

Questions

(i) Write down the chemical symbols of the metals you have used.

(ii) Using your observations, attempt to put the metals in some sort of order of reactivity.

(iii) What factors might influence the rate at which the metals react with the acid?

(iv) Name the gas(es) given off in this experiment.

(v) Write word equations for all the reactions occurring in this experiment, bearing in mind that the acid used here forms **chloride** compounds.

DISPLACEMENT REACTIONS OF METALS

Method

There are a number of solutions provided, along with a selection of metals. The object of this practical is to take a sample of a solution in a test tube and add a piece of metal to the solution.

Take a test tube rack and fill the correct number of test tubes with 5 cm³ of each metal salt solution. Add a small piece of a metal to each tube, and note down all the observations you see, both before and after the metal is added, with special note being taken of the observations of the metal added to the solution.

Note down what solutions are available, what metals are available, and construct a table using a full page of A4 paper turned on its side, similar to the table below. Enter your observations as you make them into the table.

Metal solution Metal	iron chloride	copper sulphate	zinc sulphate	magnesium chloride
magnesium				
iron				
copper				
zinc				

Questions

- Which of the metals is the most reactive? Explain your answer.
- Which metal is the least reactive? Explain your answer.
- Arrange the metals in order of their decreasing reactivity. Does this order agree with any reaction observations you have come across so far?

(iv) Write word and formulae equations for four different combinations of metal and metal salt solution that react together.

When a metal is reacted with an aqueous solution of another metal ion a reaction will occur only if the metal is higher in the reactivity series than the metal ion. This provides a relatively easy way to obtain a Reactivity Series for any group of metals.

There is another way which involves forming electrical cells with different metals and measuring the potential differences produced, though this can give a slightly different series than the chemical reactions do.

Exemplar equation -

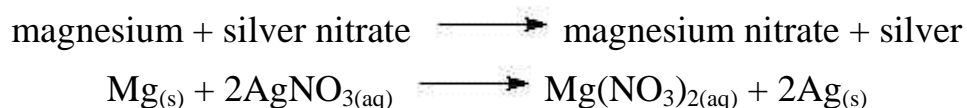

The method used to extract a metal from its ore is linked very closely to that metal's position in the Reactivity Series. The more reactive a metal is the more it wants to form compound and therefore the harder it is to isolate the pure metal from its compounds.

The most reactive metals require electricity to extract the metal; less reactive metals can be reduced with coke in a Blast furnace; the least reactive metals are found as the pure metal and require very little purification.

Summary of Reactivity Series :

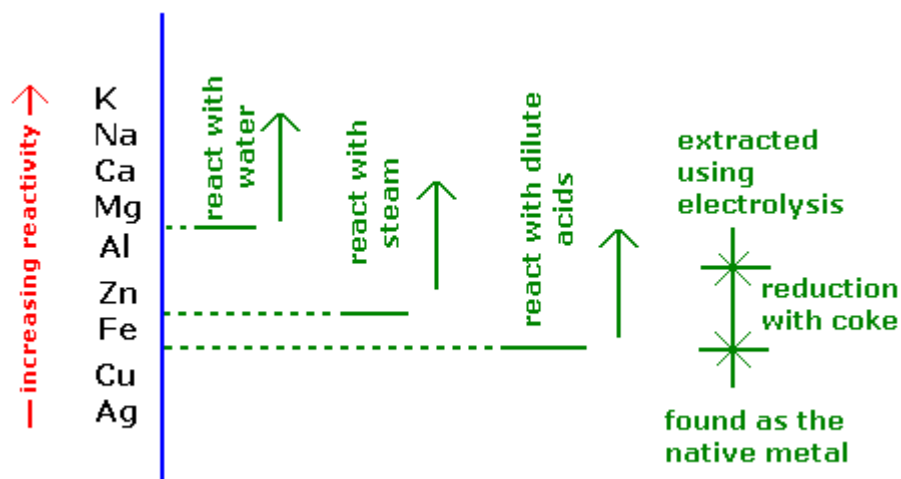

Iron(II) and iron(III) compounds can be separated by their colours most of the time. Iron(II) compounds are generally green in colour and iron(III) compounds are generally red in colour (there are plenty of exceptions though).

There is also a chemical test that can distinguish between the two sets of compounds.

When an aqueous solution of iron ions is reacted with an aqueous solution of hydroxide ions (*e.g.* sodium hydroxide or ammonium hydroxide) a coloured precipitate will be formed. A green precipitate is formed with iron(II) ions and a red-brown precipitate is formed with iron(III) ions.

The precipitates are insoluble iron hydroxides - Iron(II) hydroxide (green) and iron(III) hydroxide (red-brown).

General ionic equations are given below for the two reactions -

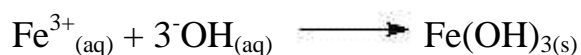
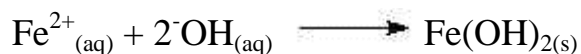

THE EXTRACTION OF IRON FROM IRON ORE: THE BLAST FURNACE

Three substances are needed to enable the extraction of iron from its ore. The combined mixture is called the **charge**:

Iron ore, haematite - often contains sand with iron oxide, Fe_2O_3 .

Limestone (calcium carbonate).

Coke - mainly carbon.

The charge is placed in a giant chimney called a **blast furnace**. The blast furnace is around 30 metres high and lined with fireproof bricks. Hot air is blasted through the bottom.

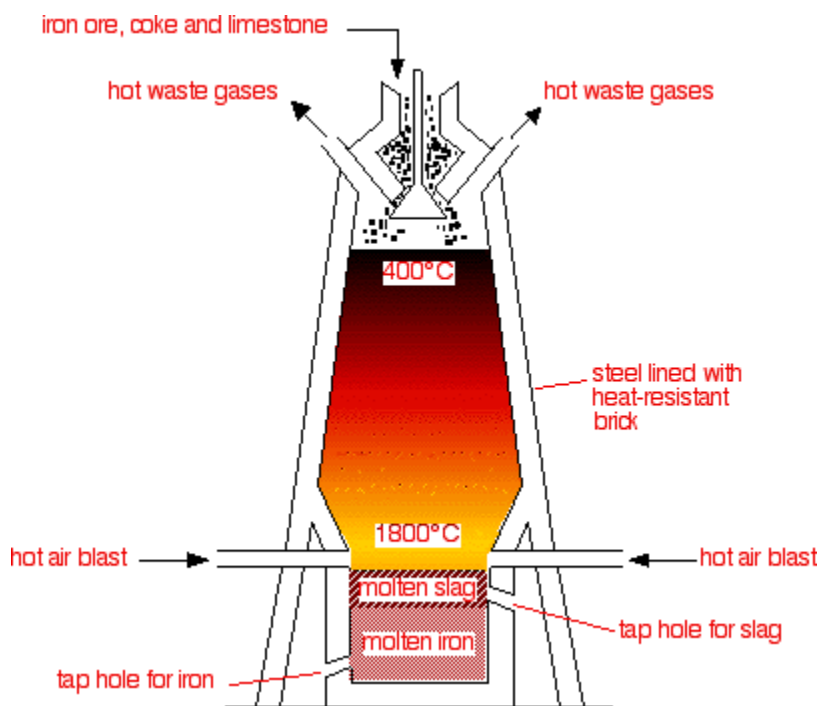

Several reactions take place before the iron is finally produced.

Oxygen in the air reacts with coke to give carbon dioxide:

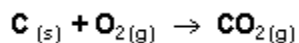

The limestone breaks down to form carbon dioxide:

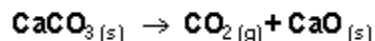

Carbon dioxide produced in 1 + 2 react with more coke to produce carbon monoxide:

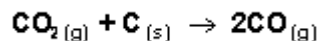

The carbon monoxide reduces the iron in the ore to give molten iron:

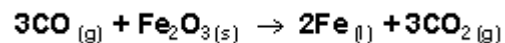

The limestone from 2, reacts with the sand to form slag (calcium silicate):

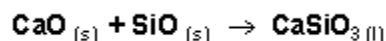

Both the slag and iron are drained from the bottom of the furnace.

The slag is mainly used to build roads.

The iron whilst molten is poured into moulds and left to solidify - this is called cast iron and is used to make railings and storage tanks.

The rest of the iron is used to make steel.

SUMMARY OF BLAST FURNACE

The raw materials needed for the blast furnace are *coke* (carbon), *limestone* (calcium carbonate, CaCO_3), heated air and the iron ore itself (*e.g. haematite*, which is iron(III) oxide, Fe_2O_3).

The solid raw materials are fed into the top of the furnace and the hot air is pumped in from near the bottom. This means that the hottest part of the reaction occurs near the bottom of the Blast furnace.

The coke burns in heated air to partially oxidise to carbon monoxide. This *carbon monoxide* is the primary *reducing agent* for the iron ore (though the coke itself will also reduce the iron ore). The coke also reduces the carbon dioxide, produced in various reactions in the furnace, to produce more carbon monoxide.

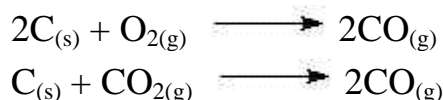

Thus the iron ore is reduced to *iron metal* which is produced at such a temperature that it is *molten*. The carbon dioxide gas is simply vented off.

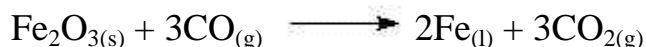

There are quite a lot of impurities present in the ore, mainly sand (silicon dioxide, SiO_2). This is removed by the limestone. When the *limestone* is heated in the furnace it *decomposes* to lime (calcium oxide) and oxygen. This *calcium oxide* reacts with the sand to produce a slag, *calcium silicate*, CaSiO_3 .

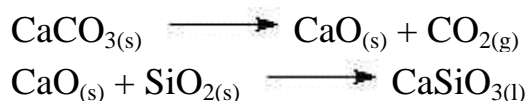

The molten iron sinks to the bottom of the furnace with the liquid slag floating on top of it. It is then a simple matter to allow the slag to flow away and obtain the iron from beneath it.

RUSTING OF IRON

Rusting is a very specific reaction of iron, where the metal is turned into hydrated iron(III) oxide, known as rust.

For iron to rust the metal must be in contact with air and water. Without either one of these the metal will remain intact and not corrode.

There are a number of separate stages involved, such as the oxidation of iron to iron(II) ions and then the oxidation of iron(II) ions into the iron(III) oxide,

Equation -



These processes involve the movement of electrons and as such the rusting process can be speeded up by having salt present in the water, as this allows greater conductivity.

RUST PREVENTION

Anything that prevents air and/or water from contacting the surface of the iron will prevent the metal from rusting; as does anything that reacts faster than the iron, *i.e.* is higher in the reactivity series.

In the latter case the oxygen and water will preferentially react with the more reactive metal, to form metal oxides, before the iron can react. This allows the overall strength of the metal to remain the same.

Common methods for rust prevention involve *painting* the metal; covering the metal in oil or grease; coating the metal in zinc, called *galvanising*; attaching blocks of a more reactive metal, such as magnesium or zinc, called *sacrificial protection*; *alloying* the iron with other metals, such as chromium and nickel, or changing the carbon content of the iron to create steel.

ALLOYS

Metals are mixed together to create alloys. These alloys have better physical properties than the individual metals, such as higher melting points, greater mechanical strength or increased resistance to corrosion.

Steel -

Steel is an alloy created by blowing oxygen through molten iron produced in the Blast furnace. The oxygen reacts with the carbon impurity in the iron, turning it into carbon dioxide, which is vented off. The amount of carbon can be very carefully controlled, giving a wide range of different steels. For example, mild steel has about 0.25% carbon and is hard and strong; whilst high carbon steel has about 1.5% carbon and is harder but more brittle.

Other metals can also be added to the steel as it is made to make an alloy such as stainless steel. For this chromium and nickel are added which form unreactive oxides on the surface of the iron and prevent the rusting process starting.

Others -

A few other common alloys are bronze, which is a mixture of copper and tin; brass, which is a mixture of copper and zinc; solder and pewter, which are mixtures of tin and lead.

Even gold used for jewelry is alloyed with other metals such as zinc or nickel to produce normal gold as well as white gold.

HEATING HYDROXIDES

Sodium hydroxide and potassium hydroxide are NOT CHANGED by heating them.

Calcium hydroxide and magnesium hydroxide behave in the same way.

HYDROXIDE + HEAT = OXIDE + WATER

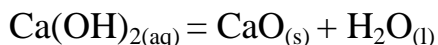

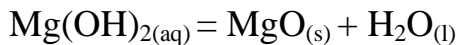

Iron (III) hydroxide is also decomposed by heating to form iron (III) oxide and water.



HEATING NITRATES

Group 1 nitrate + heat = group 1 nitrite + oxygen gas



All other nitrates behave in the same way when heated

NITRATE + HEAT = OXIDE + NITRITE + OXYGEN GAS

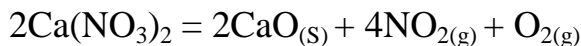

NOTE: NITROGEN DIOXIDE IS A POISONOUS BROWN GAS THAT IS A MAJOR AIR POLLUTANT. ALL THESE REACTIONS MUST BE DONE IN A FUME CUPBOARD.

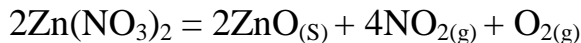
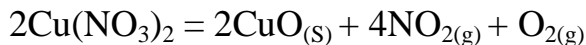
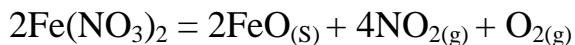

UNREACTIVITY OF ALUMINIUM

Aluminium's position in the middle of the reactivity series should mean that it is quite a reactive metal. It isn't.

It does not react with acids and is resistant to corrosion.

Although it may look shiny, aluminium has a THIN COATING OF ALUMINIUM OXIDE all over its surface. Aluminium oxide is VERY UNREACTIVE AND PROTECTS THE ALUMINIUM METAL BELOW.

EXTRACTION OF COPPER FROM ITS ORE MALACHITE

Copper is extracted by heating the mineral malachite (copper (II) carbonate CuCO_3) with CARBON. The reaction has 2 stages:

1. THE MALACHITE DECOMPOSES

Copper (II) carbonate = copper (II) oxide + carbon dioxide



2. THE COPPER (II) OXIDE IS REDUCED BY CARBON

Copper (II) oxide + carbon = copper metal + carbon dioxide gas

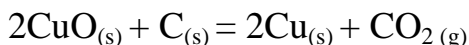

The copper that is produced is further purified in electrolysis.

EXTRACTION OF ZINC

Zinc is extracted from ZINC BLENDE. Zinc blende is Zinc sulphide ZnS .

The zinc is first heated in air to convert it to zinc oxide

Zinc Blende + oxygen gas = sulphur dioxide gas + zinc oxide

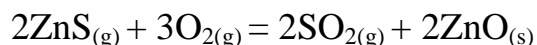

The oxide is then reduced using carbon monoxide gas

Zinc oxide + carbon monoxide gas = zinc metal + carbon dioxide gas

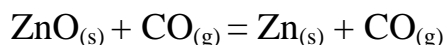

USES OF METALS

The uses of aluminium are based on the fact that it has a low density, is strong as well as being unreactive (due to a layer of aluminium oxide on the surface)

It is used in the manufacture of aircraft (light and strong), drinks cans (doesn't corrode and can be recycled).

Zinc is used to make the alloy brass by reacting it with copper. Covering iron with zinc is called GALVANIZING. It stops the iron from rusting underneath.

Copper is an excellent conductor of heat with a high melting point. It is also an excellent conductor of electricity and is used for electrical wires and cables.

MAKING STEEL FROM IRON

Iron from the blast furnace is brittle (snaps) and corrodes very easily because it contains a large amount of carbon (from the coke). The corrosion of iron is called RUSTING. It is a chemical reaction between IRON, OXYGEN AND WATER. SALT ALSO SPEEDS UP RUSTING.

Common ways to stop rusting are:

1. GALVANIZING – Cover the iron with zinc. More reactive zinc corrodes and is SACRIFICED to PROTECT the less reactive iron underneath. This is called SACRIFICIAL PROTECTION. This is why ZINC BLOCKS are found at the front of ships to stop the iron hull of the ship from corroding.
2. ALLOYING – Mixing other metals to the iron to make STEEL.

In steel making, molten iron (from the blast furnace) is mixed with smaller amounts of scrap (WASTE) iron and steel. Limestone is also added and the whole mixture is melted. Oxygen is blasted into the mixture which reacts with carbon in the iron to make carbon monoxide gas.

THIS PROCESS OF MAKING STEEL IS CALLED THE BASIC OXYGEN PROCESS.

The carbon monoxide gas is recycled back into the TOP of the blast furnace.

The limestone in the mixture is decomposed by heat into LIME (CALCIUM OXIDE) and CARBON DIOXIDE GAS.

The oxygen that is blown through the blast furnace also converts any impurities into their oxides. The lime reacts with these oxides to form SLAG and so they are removed from the iron and steel mixture.

Steel is iron with a carbon content up to 1.5%. Steel is RESISTANT TO CORROSION and LESS BRITTLE than iron and doesn't snap easily.

Steel has a wide range of uses depending on its carbon content.

MILD STEEL (LESS THAN 0.3% CARBON) –CAR BODIES

MEDIUM STEEL (0.3 TO 1% CARBON) – RAILWAY TRACKS

HARD STEEL (1 TO 1.5% CARBON) – KNIVES

STAINLESS STEELS

These are made by reacting a wide range of metals to steel such as chromium, vanadium, nickel and cobalt.

Each one gives the steel special properties for special uses.

Chromium/Vanadium steel is used for drilling metal and glass.

The most common use of stainless steel is for CUTLERY – KNIVES, FORKS AND SPOONS.

TOPIC 11 – AIR AND WATER

A CHEMICAL TEST FOR WATER

Add the water to anhydrous white copper sulphate crystals. If the crystals turn blue, the liquid you have added is water.

The reaction can also be reversed by heating the blue crystals. Steam is produced and the crystals turn white again.

THE WATER CYCLE

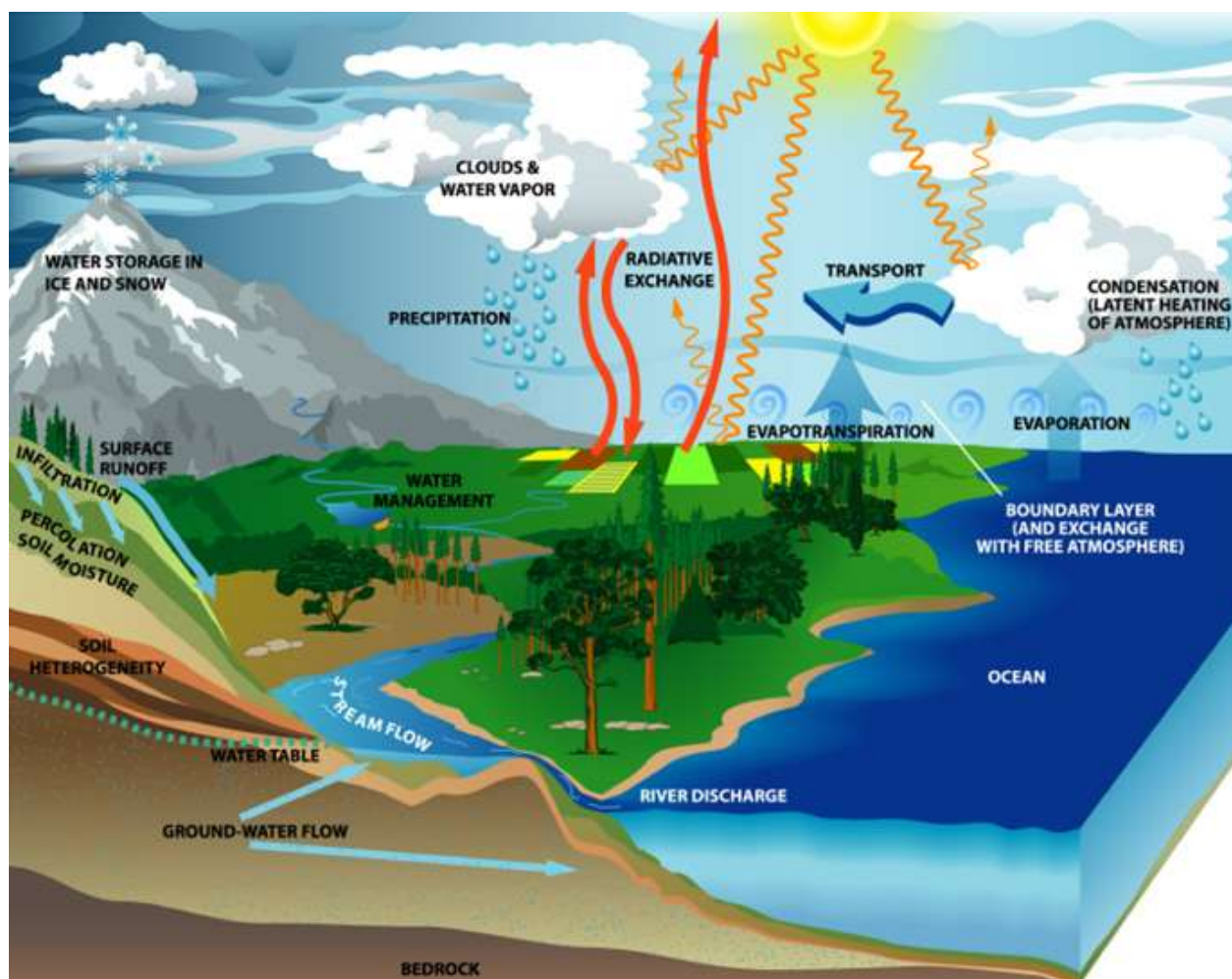

The recirculation of water all over the Earth's surface is called the WATER CYCLE.

The pattern of rainfall determines where there is desert, rainforests and areas of land that can or cannot be used for growing things. Rainfall therefore determines the ECONOMIC WEALTH of the countries of the world.

GLOBAL WARMING

This is thought to be responsible for CLIMATE CHANGES that are affecting where there is rainfall and also how much of it that there is. Al Gore thinks global warming is a problem (watch his video An Inconvenient Truth) but George Bush, U.S president seems to think it is make believe. What do you think?

Water is essential for life on Earth. The demand for drinking water is increasing as the earth's population has grown from 2 billion people to 6 billion people since the end of World War 2 in 1945.

Most INDUSTRIAL PROCESSES use water as either a RAW MATERIAL or for cooling processes. Two-thirds of the water is used in the home. The rest is used by industry.

It takes, for example, 250,000 tonnes of water to make just one tonne of steel.

Water stored in reservoirs needs to be purified to make drinkable water.

Additionally, tap water in certain areas is treated with SODIUM FLUORIDE NaF to help to prevent tooth decay.

WATER PURIFICATION PROCESS

1. Water from a reservoir goes to a water treatment plant
2. Water is filtered through coarse gravel to remove large dirt particles
3. Water is filtered through beds of fine gravel and sand to remove the smallest particles
4. Chlorine is passed through to kill bacteria and germs
5. Water is supplied directly to your home and industry

COMPOSITION OF CLEAN DRY AIR

NAME OF GAS	PERCENTAGE PRESENT
NITROGEN GAS	78
OXYGEN GAS	21
ARGON GAS	0.9
CARBONN DIOXIDE GAS	0.03
OTHERS	0.07

For those of you that want to study this in more detail:

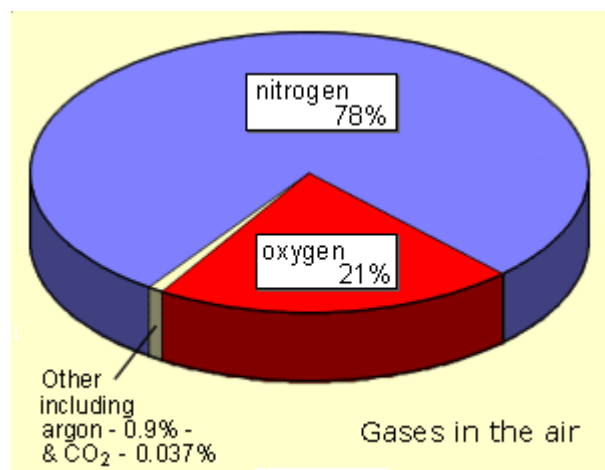

Chemical Composition of Air		
Name	Symbol	% by volume
Nitrogen	N ₂	78.084 %
Oxygen	O ₂	20.9476 %
Argon	Ar	0.934 %
Carbon Dioxide	CO ₂	0.0314 %
Neon	Ne	0.001818 %
Methane	CH ₄	0.0002 %
Helium	He	0.000524 %
Krypton	Kr	0.000114 %
Hydrogen	H ₂	0.00005 %
Xenon	Xe	0.0000087 %

THE NITROGEN CYCLE

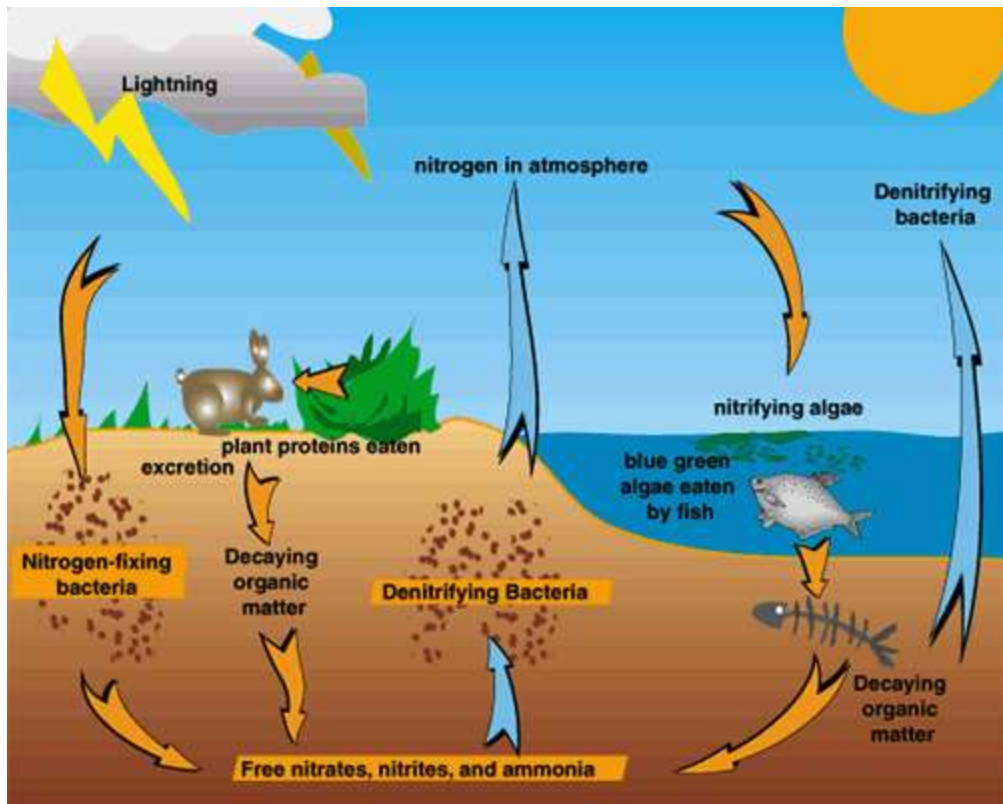

In the nitrogen cycle:

1. **NITROGEN FIXING BACTERIA** take nitrogen from the air (you must remember there is also nitrogen gas present in soil!) to form nitrogen-containing compounds such as nitrates. Some of these bacteria live in the soil or root nodules of plants.
2. **NITRIFYING BACTERIA** convert ammonia (from the decayed remains and waste products of animals and plants) into nitrates.
3. **DENITRIFYING BACTERIA** convert nitrates in the soil back into nitrogen gas in the air
4. Animals get extra nitrogen when they eat animal or plant proteins.

POLLUTANTS IN THE AIR

Some of these pollutants come from burning waste, some from power stations that burn coal and gas. Some are pollutant gases from industrial processes too.

The commonest pollutants of air are:

1. CARBON MONOXIDE – incomplete combustion of hydrocarbon fuels like petrol, coal, gas and diesel.
2. SULPHUR DIOXIDE – burning petrol and coal
3. OXIDES OF NITROGEN – burning fossil fuels – petrol, diesel and coal
4. LEAD COMPOUNDS – burning leaded petrol

Burning fossil fuels causes two main environmental impacts – the greenhouse effect and acid rain.

THE GREENHOUSE EFFECT

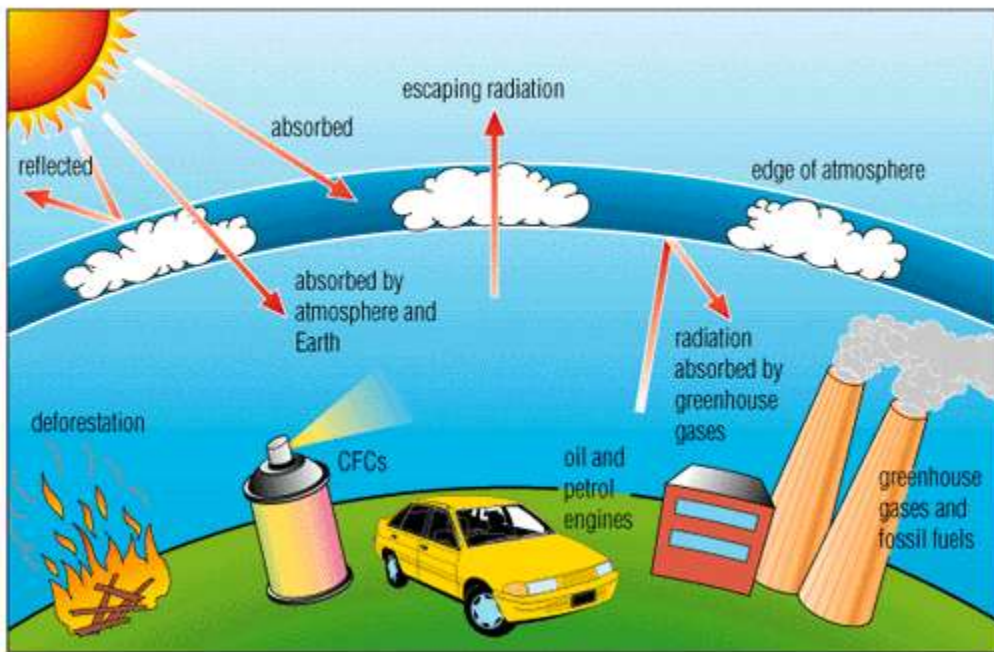

Carbon dioxide, methane and CFC's are GREENHOUSE GASES. The levels of these gases in the atmosphere is increasing all the time due to Earth's increasing use of fossil fuels, pollutants from animal waste and the increased use of aerosols and refrigerants.

Short wave radiation from the sun warms the ground. The warm Earth gives off heat as long-wave radiation. Much of this radiation cannot escape the Earth as it is trapped by the greenhouse gases in the atmosphere. This is called THE GREENHOUSE EFFECT.

The greenhouse effect is responsible for GLOBAL WARMING – this means the Earth is warmer than what it would be normally. Increasing levels of greenhouse gases are stopping heat from escaping from Earth and the Earth's average temperature is increasing all of the time.

If global warming continues, the Earth's climate will change forever. Polar ice caps are starting to melt and raise sea levels.

In 30 years if this continues, low-lying countries like Holland, Bangladesh and Kuwait will be under water.

We do not know for certain that greenhouse gases are the only thing responsible for the average Earth temperature rising steadily. It may be that these temperature increases may be part of a natural cycle – in the past there have been Ice Ages followed by very warm periods of time on Earth. Many people are concerned, however, that it is not part of a natural cycle so we should ACT NOW TO STOP GREENHOUSE GASES BEING MADE AND PREVENT GLOBAL WARMING.

Atmospheric Carbon Dioxide Concentration and Temperature Change

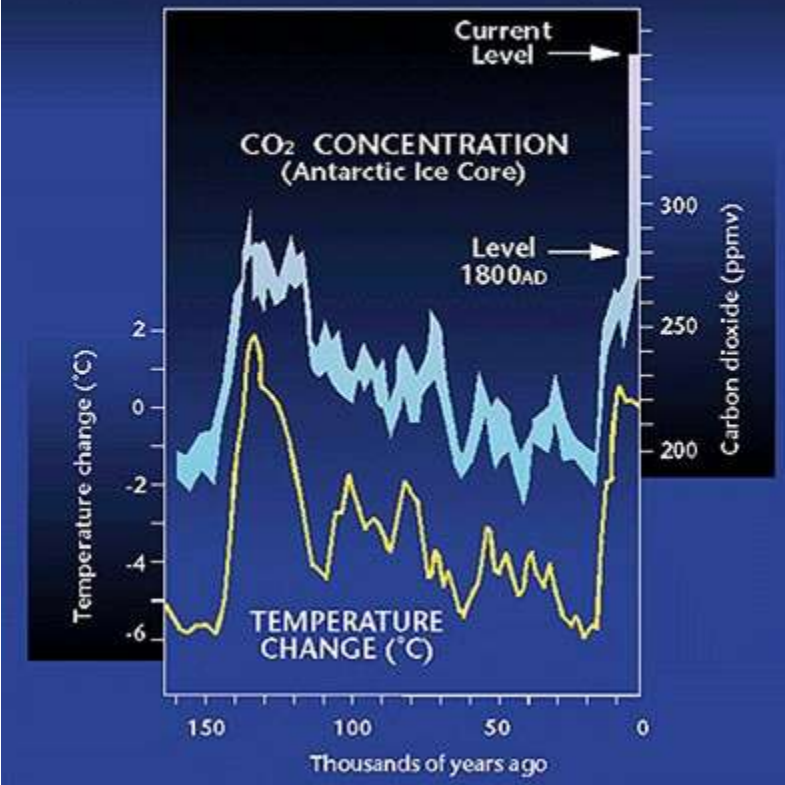

GRAPH TO SHOW HOW CO₂ LEVELS ON EARTH INCREASED BETWEEN 1991 AND 1999

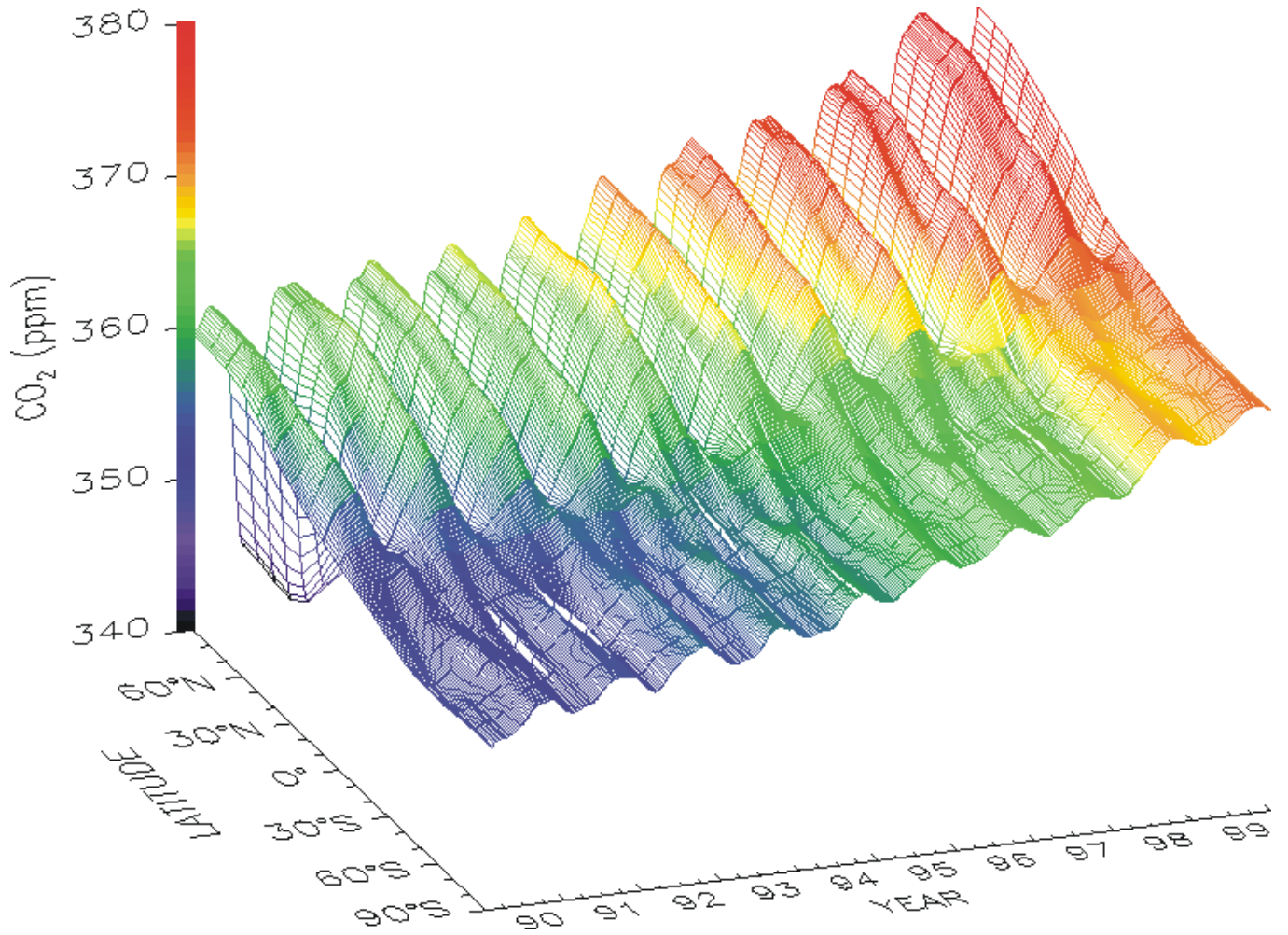

ACID RAIN

Burning fossil fuels gives off many gases including SULPHUR DIOXIDE and various NITROGEN OXIDES.

SULPHUR + OXYGEN = SULPHUR DIOXIDE GAS

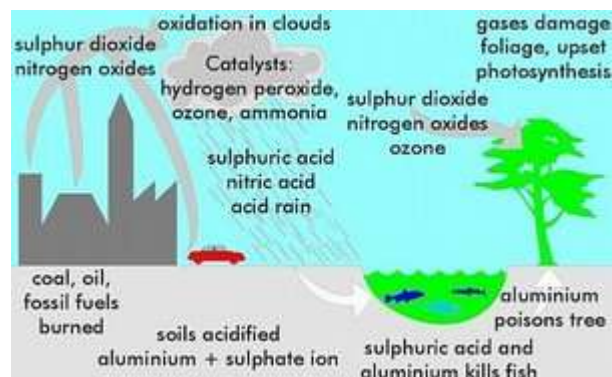
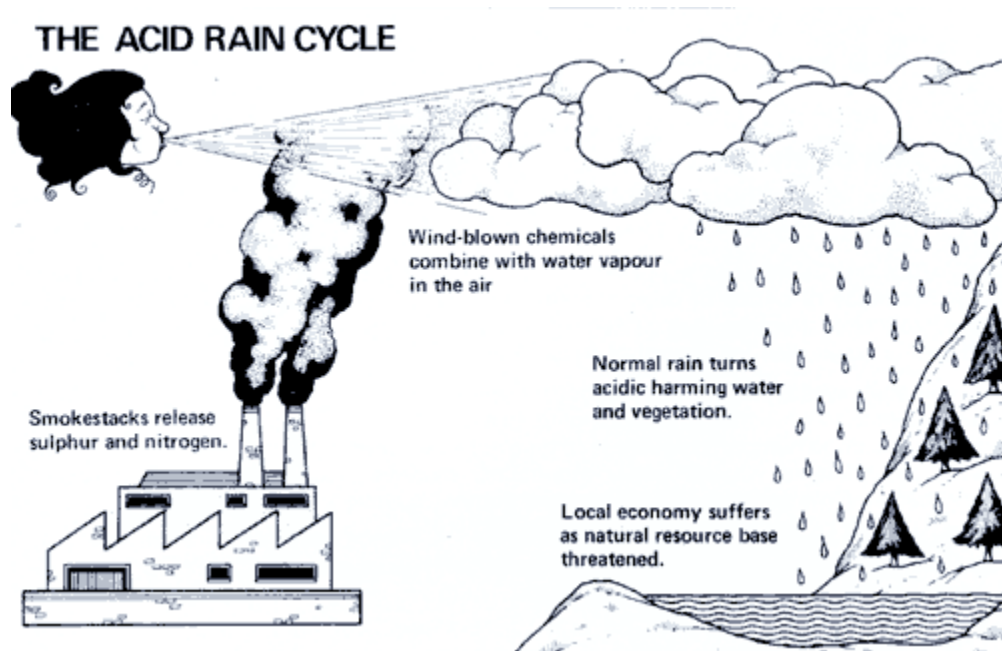
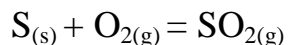

Sulphur dioxide combines with water in clouds and in the air to form **SULPHURIC ACID**.

SULPHUR DIOXIDE + OXYGEN + WATER = SULPHURIC ACID

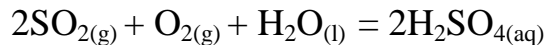

Nitrogen oxide combines with water in a similar way to make **NITRIC ACID**.

These 2 gases in water form a combination of acids called **ACID RAIN**.

Limestone and marble buildings (both made of calcium carbonate CaCO_3) are damaged by acid rain. Metal structures are also attacked by sulphuric acid.

Acid rain **HARMS PLANTS AND TREES** that take in acidic water.



Here are some trees in Norway that have been killed by acid rain.

Acid rain can also kill life in rivers, streams and lakes.

In Norway and Sweden, rivers are treated with an alkali called LIME which is sprayed onto the rivers to NEUTRALIZE the acidity of the RAINWATER.



Acid rain also washes out ions such as calcium and magnesium out of the soil.

These ions are ESSENTIAL IONS for plant growth. Plants need magnesium to make the green pigment CHLOROPHYLL which traps the sunlight when a plant makes food by PHOTOSYNTHESIS.

Reducing emission of acid rain gases is expensive. Part of the problem is that strong winds blow the gases far away from where they were made. Much of the acid rain in Norway and Sweden comes from power stations in the UK.

Power stations are now fitted with 'DESULPHURIZATION FILTERS' to stop and greatly reduce the amount of sulphur dioxide pollution into the atmosphere.

ULTRA LOW SULPHUR PETROLS are now used for the same reason.

CATALYTIC CONVERTERS

These are now fitted to ALL cars as STANDARD

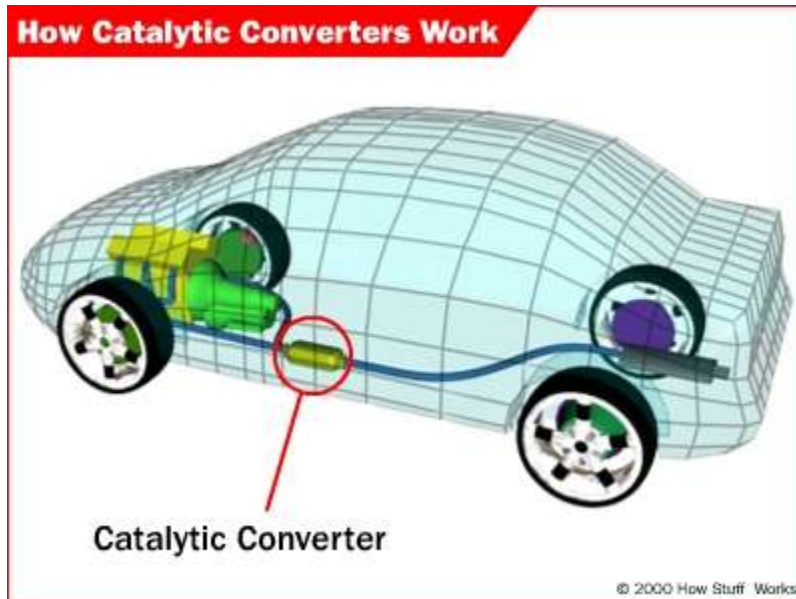

Catalytic converters are fitted to car exhaust systems of vehicles to reduce the level of pollutants being released into the air from burning petrol.

CATALYTIC CONVERTER

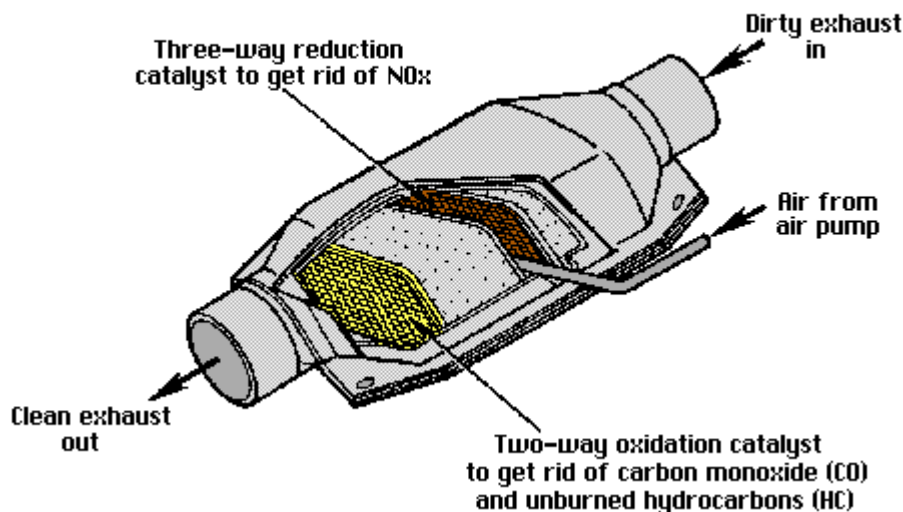

The catalytic converters change emissions such as carbon monoxide (CO) and nitrogen oxides like Nitrogen Monoxide NO into less harmful nitrogen gas, carbon dioxide gas and water vapour.

The catalytic converter is usually made from a mixture of transition metals as an alloy. If leaded petrol is added by mistake, the catalytic converter stops working as it is **POISONED** by the lead compounds which stick or **ADSORB** to the surface. The car will stop and the catalytic converter becomes totally useless.

USES OF OXYGEN GAS

In medicine, oxygen is used to help people breathe. It is used in **OXYGEN TENTS**. Oxygen is also needed for combustion and burning. It is also used in **WELDING** to burn with acetylene (**ETHYNE**) gas C_2H_2 to make the acetylene burn at such a high temperature that it can melt metal.

FRACTIONAL DISTILLATION OF LIQUID AIR

Air is filtered to remove dust, and then cooled in stages until it reaches -200°C . At this temperature it is a liquid. We say that the air has been liquefied.

Here's what happens as the air liquefies:

- water vapour condenses, and is removed using absorbent filters
- carbon dioxide freezes at -79°C , and is removed
- oxygen liquefies at -183°C
- nitrogen liquefies at -196°C

The liquid nitrogen and oxygen are then separated by fractional distillation.

Fractional distillation

The liquefied air is passed into the bottom of a fractionating column. Just as in the columns used to separate oil fractions, the column is warmer at the bottom than it is at the top.

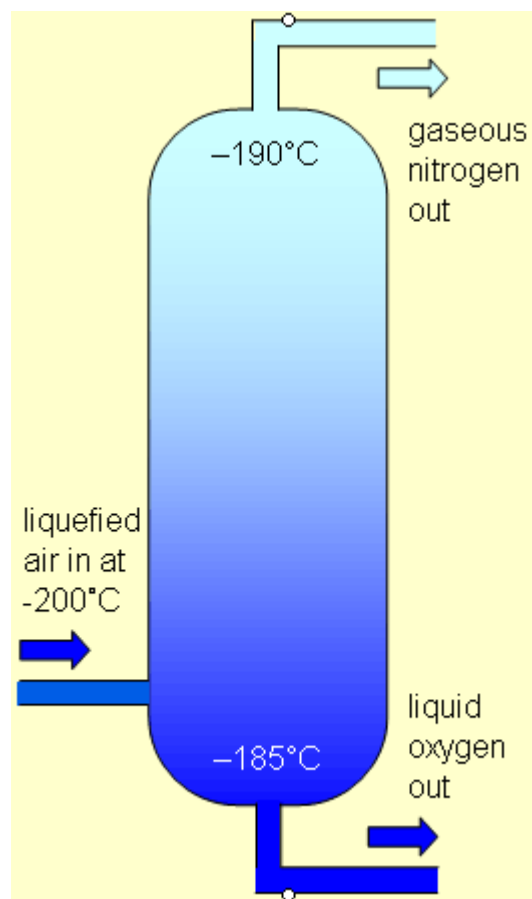

The liquid nitrogen boils at the bottom of the column. Gaseous nitrogen rises to the top, where it is piped off and stored. Liquid oxygen collects at the bottom of the column. The boiling point of argon (the noble gas that forms 0.9% of the air) is close to the boiling point of oxygen, so a second fractionating column is often used to separate the argon from the oxygen.

Uses of nitrogen and oxygen

- liquid nitrogen is used to freeze food
- food is packaged in gaseous nitrogen to increase its shelf life
- oil tankers are flushed with gaseous nitrogen to reduce the chance of explosion
- oxygen is used in the manufacture of steel and in medicine

NITROGEN COMPOUNDS

Fertilizers contain minerals that make a plant grow quick and healthy.

THEY ARE OFTEN CALLED NPK FERTILIZERS. They contain the elements nitrogen (N) phosphorus (P) and potassium (K). Nitrogen compounds make plant proteins, phosphorus makes plant roots grow and potassium makes the flowers and fruits of plants.

THE INDUSTRIAL MANUFACTURE OF AMMONIA BY THE HABER PROCESS

A brief summary of the Haber Process

The Haber Process combines nitrogen from the air with hydrogen derived mainly from natural gas (methane) into ammonia. The reaction is reversible and the production of ammonia is exothermic.

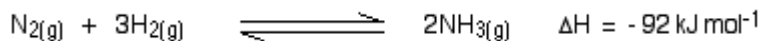

FLOW SCHEME FOR THE HABER PROCESS

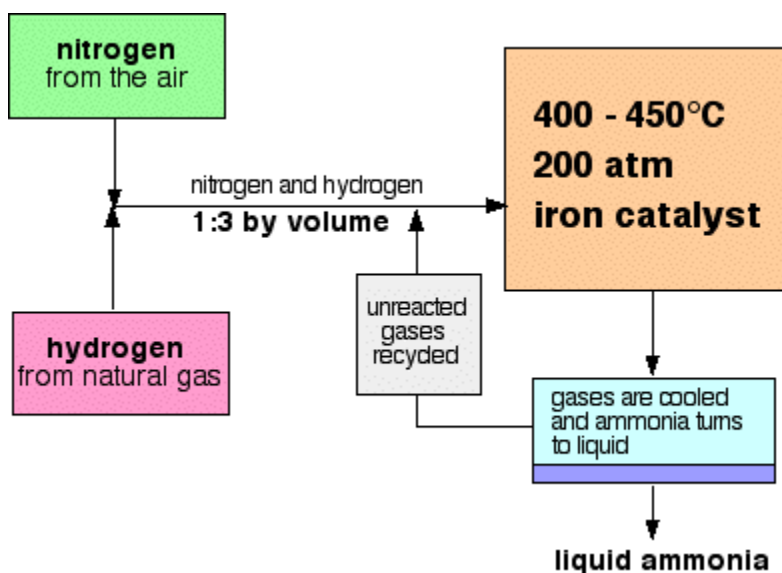

REACTION CONDITIONS IN THE HABER PROCESS

The catalyst

The catalyst is actually slightly more complicated than pure iron. It has potassium hydroxide added to it as a promoter - a substance that increases its efficiency.

The pressure

The pressure varies from one manufacturing plant to another, but is always high. You can't go far wrong in an exam quoting 200 atmospheres.

Recycling

At each pass of the gases through the reactor, only about 15% of the nitrogen and hydrogen converts to ammonia. (This figure also varies from plant to plant.) By continual recycling of the unreacted nitrogen and hydrogen, the overall conversion is about 98%.

Explaining the conditions

The proportions of nitrogen and hydrogen

The mixture of nitrogen and hydrogen going into the reactor is in the ratio of 1 volume of nitrogen to 3 volumes of hydrogen.

Avogadro's Law says that equal volumes of gases at the same temperature and pressure contain equal numbers of molecules. That means that the gases are going into the reactor in the ratio of 1 molecule of nitrogen to 3 of hydrogen.

That is the proportion demanded by the equation.

In some reactions you might choose to use an excess of one of the reactants. You would do this if it is particularly important to use up as much as possible of the other reactant - if, for example, it was much more expensive. That doesn't apply in this case.

There is always a down-side to using anything other than the equation proportions. If you have an excess of one reactant there will be molecules passing through the reactor which can't possibly react because there isn't anything for them to react with. This wastes reactor space - particularly space on the surface of the catalyst.

The temperature

Equilibrium considerations

You need to shift the position of the equilibrium as far as possible to the right in order to produce the maximum possible amount of ammonia in the equilibrium mixture.

The forward reaction (the production of ammonia) is exothermic.



According to Le Chatelier's Principle, this will be favoured if you lower the temperature. The system will respond by moving the position of equilibrium to counteract this - in other words by producing more heat.

In order to get as much ammonia as possible in the equilibrium mixture, you need as low a temperature as possible. However, 400 - 450°C isn't a low temperature!

Rate considerations

The lower the temperature you use, the slower the reaction becomes. A manufacturer is trying to produce as much ammonia as possible per day. It makes no sense to try to achieve an equilibrium mixture which contains a very high proportion of ammonia if it takes several years for the reaction to reach that equilibrium.

You need the gases to reach equilibrium within the very short time that they will be in contact with the catalyst in the reactor.

The compromise

400 - 450°C is a compromise temperature producing a reasonably high proportion of ammonia in the equilibrium mixture (even if it is only 15%), but in a very short time.

The pressure

Equilibrium considerations



Notice that there are 4 molecules on the left-hand side of the equation, but only 2 on the right.

According to Le Chatelier's Principle, if you increase the pressure the system will respond by favouring the reaction which produces fewer molecules. That will cause the pressure to fall again.

In order to get as much ammonia as possible in the equilibrium mixture, you need as high a pressure as possible. 200 atmospheres is a high pressure, but not amazingly high.

Rate considerations

Increasing the pressure brings the molecules closer together. In this particular instance, it will increase their chances of hitting and sticking to the surface of the catalyst where they can react. The higher the pressure the better in terms of the rate of a gas reaction.

Economic considerations

Very high pressures are very expensive to produce on two counts.

You have to build extremely strong pipes and containment vessels to withstand the very high pressure. That increases your capital costs when the plant is built.

High pressures cost a lot to produce and maintain. That means that the running costs of your plant are very high.

The compromise

200 atmospheres is a compromise pressure chosen on economic grounds. If the pressure used is too high, the cost of generating it exceeds the price you can get for the extra ammonia produced.

The catalyst

Equilibrium considerations

The catalyst has no effect whatsoever on the position of the equilibrium. Adding a catalyst doesn't produce any greater percentage of ammonia in the equilibrium mixture. Its only function is to speed up the reaction.

Rate considerations

In the absence of a catalyst the reaction is so slow that virtually no reaction happens in any sensible time. The catalyst ensures that the reaction is fast enough for a dynamic equilibrium to be set up within the very short time that the gases are actually in the reactor.

Separating the ammonia

When the gases leave the reactor they are hot and at a very high pressure. Ammonia is easily liquefied under pressure as long as it isn't too hot, and so the temperature of the mixture is lowered enough for the ammonia to turn to a liquid. The nitrogen and hydrogen remain as gases even under these high pressures, and can be recycled.

SUMMARY DIAGRAM OF HABER PROCESS

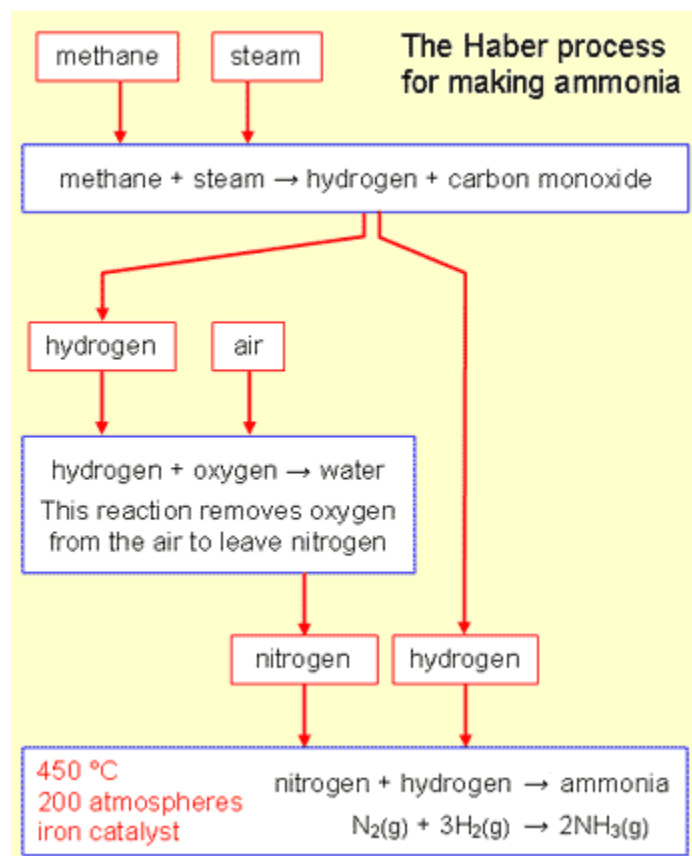

SUMMARY OF EFFECTS OF TEMPERATURE IN HABER PROCESS

Maximising yield

The temperature and pressure are chosen to obtain a good yield of ammonia in a short time. This involves a compromise between maximum yield and speed of reaction. As you can see from the graph, ammonia yield is increased by very high pressures, but decreased by very high temperatures.

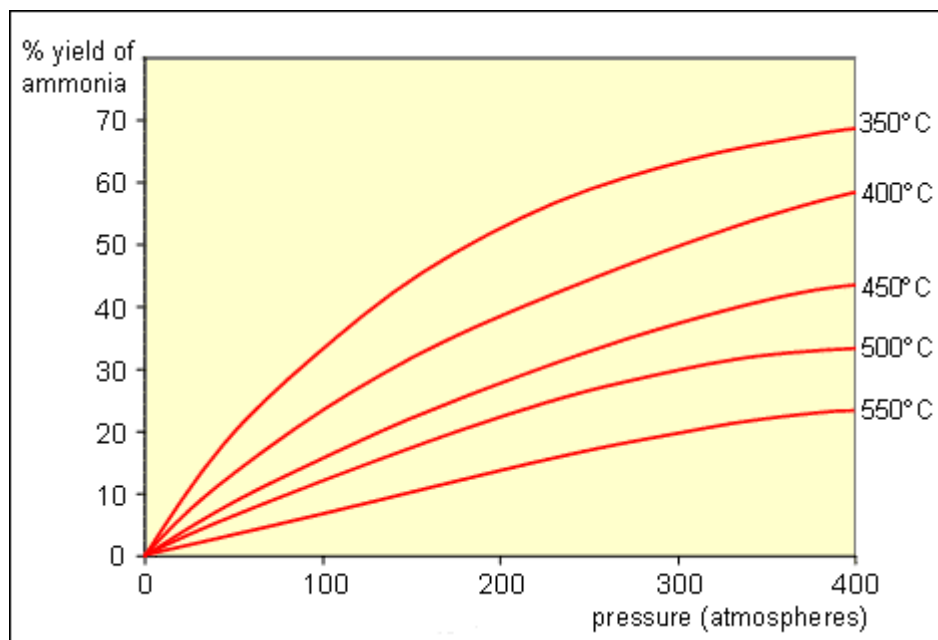

However, lowering the temperature (apart from being difficult at high pressures) slows down the reaction. The conditions chosen are a compromise between these conflicting factors:

1. Increasing the pressure above 200 atmospheres would improve yield, but would also raise temperature, and make the plant much more expensive to build.
2. Decreasing the temperature below 450°C would slow the reaction down too much and make it hard to maintain sufficiently high pressure.
3. So a balance is struck at 200 atmospheres and 450°C.

In addition, two other steps are taken to maximise yield. Firstly, the ammonia is cooled until it **liquefies** and is then removed, thus causing more of the nitrogen and hydrogen to react. Secondly, any unreacted nitrogen and hydrogen is recycled to give it another chance to react.

AMMONIUM SALTS

These salts will react with a base to produce AMMONIA GAS. An example is the reaction of ammonium chloride with calcium hydroxide to make ammonia gas.

The gas is tested and is **THE ONLY ALKALI GAS. IT TURNS RED LITMUS BLUE**

CARBON DIOXIDE GAS

This gas is easily made in the laboratory by adding hydrochloric acid to marble chips. The gas is made by **DOWNWARD DELIVERY** as it is **HEAVIER THAN AIR**.

WE CAN TEST FOR CO₂ AS IT WILL TURN LIMEWATER MILKY OR PUT OUT A LIGHTED SPLINT.

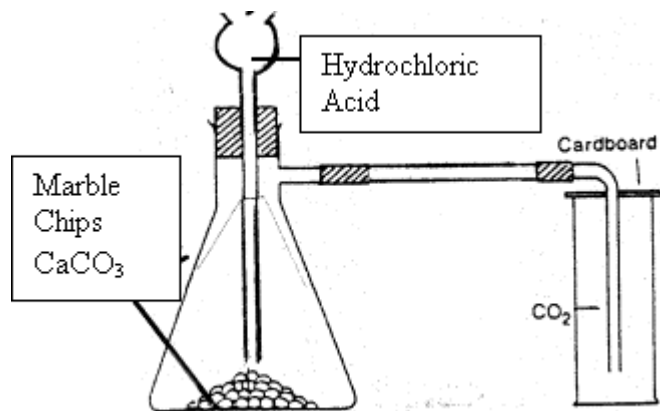

Carbon dioxide gas is also formed from combustion. Most of the common fuels today are **HYDROCARBONS** – They contain only **HYDROgen** and **CARBON**.

When a hydrocarbon is burnt in a large amount of air (complete combustion), it reacts with the oxygen in the air (**IT IS OXIDISED**) to form **CARBON DIOXIDE AND WATER**.

This is an **EXAMPLE OF COMBUSTION**

FUEL + OXYGEN GAS = CARBON DIOXIDE AND WATER

BURNING METHANE (NATURAL GAS)

Methane + oxygen = carbon dioxide gas + water

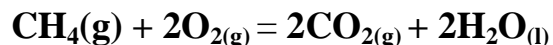

Carbon dioxide is also a **PRODUCT OF RESPIRATION**.

Plants take in carbon dioxide and combine it with water to make sugar + oxygen.

This process is called PHOTOSYNTHESIS.

Carbon dioxide circulates on Earth as a CARBON CYCLE. This is covered in detail in your IGSE syllabus but a FLOWCHART is included here as a reminder.

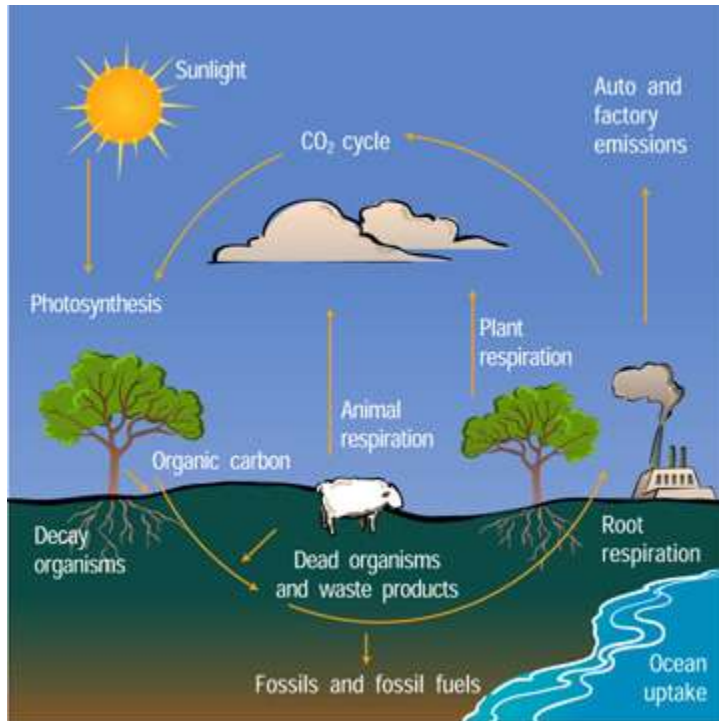

TOPIC 12 – SULPHUR AND THE CONTACT PROCESS

Sulphur is found in many places in the world and is often released by volcanoes. Compounds of sulphur are called SULPHIDES.

Sulphur is mainly used for the MANUFACTURE OF SULPHURIC ACID by the CONTACT PROCESS. This is an examination favourite.

Sulphur dioxide is used as a bleach in manufacture of wood pulp for paper. It is also used to preserve food by killing bacteria.

THE CONTACT PROCESS – THE INDUSTRIAL MANUFACTURE OF SULPHURIC ACID H_2SO_4

A brief summary of the Contact Process

The Contact Process:

- makes sulphur dioxide;
- converts the sulphur dioxide into sulphur trioxide (the reversible reaction at the heart of the process);
- converts the sulphur trioxide into concentrated sulphuric acid.

Making the sulphur dioxide

This can either be made by burning sulphur in an excess of air:

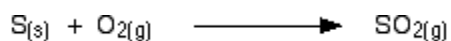

. . . or by heating sulphide ores like iron pyrites (fool's gold) or zinc sulphide (zinc blende) in a furnace in an excess of air:

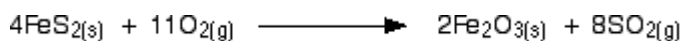

In either case, an excess of air is used so that the sulphur dioxide produced is already mixed with oxygen for the next stage.

Converting the sulphur dioxide into sulphur trioxide

This is a reversible reaction, and the formation of the sulphur trioxide is exothermic.



FLOW SCHEME FOR THE HABER PROCESS

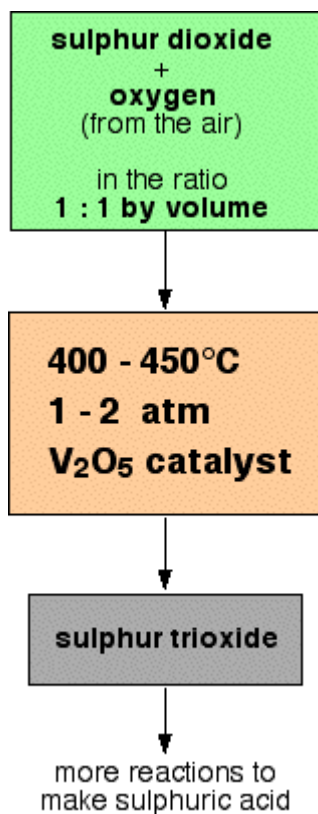

Converting the sulphur trioxide into sulphuric acid

This can't be done by simply adding water to the sulphur trioxide - the reaction is so uncontrollable that it creates a fog of sulphuric acid. Instead, the sulphur trioxide is first dissolved in concentrated sulphuric acid:

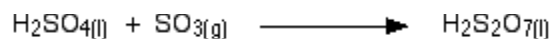

The product is known as *fuming sulphuric acid* or *oleum*.

This can then be reacted safely with water to produce concentrated sulphuric acid - twice as much as you originally used to make the fuming sulphuric acid.

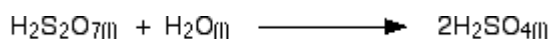

Explaining the conditions

The proportions of sulphur dioxide and oxygen

The mixture of sulphur dioxide and oxygen going into the reactor is in equal proportions by volume.

Avogadro's Law says that equal volumes of gases at the same temperature and pressure contain equal numbers of molecules. That means that the gases are going into the reactor in the ratio of 1 molecule of sulphur dioxide to 1 of oxygen.

That is an excess of oxygen relative to the proportions demanded by the equation.

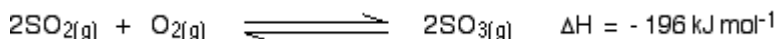

According to Le Chatelier's Principle, Increasing the concentration of oxygen in the mixture causes the position of equilibrium to shift towards the right. Since the oxygen comes from the air, this is a very cheap way of increasing the conversion of sulphur dioxide into sulphur trioxide.

Why not use an even higher proportion of oxygen? This is easy to see if you take an extreme case. Suppose you have a million molecules of oxygen to every molecule of sulphur dioxide.

The equilibrium is going to be tipped very strongly towards sulphur trioxide - virtually every molecule of sulphur dioxide will be converted into sulphur trioxide. Great! But you aren't going to produce much sulphur trioxide every day. The vast majority of what you are passing over the catalyst is oxygen which has nothing to react with.

By increasing the proportion of oxygen you can increase the percentage of the sulphur dioxide converted, but at the same time decrease the total amount of sulphur trioxide made each day. The 1 : 1 mixture turns out to give you the best possible overall yield of sulphur trioxide.

The temperature

Equilibrium considerations

You need to shift the position of the equilibrium as far as possible to the right in order to produce the maximum possible amount of sulphur trioxide in the equilibrium mixture.

The forward reaction (the production of sulphur trioxide) is exothermic.

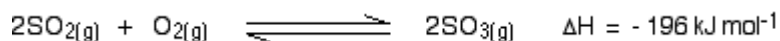

According to Le Chatelier's Principle, this will be favoured if you lower the temperature. The system will respond by moving the position of equilibrium to counteract this - in other words by producing more heat.

In order to get as much sulphur trioxide as possible in the equilibrium mixture, you need as low a temperature as possible. However, 400 - 450°C isn't a low temperature!

Rate considerations

The lower the temperature you use, the slower the reaction becomes. A manufacturer is trying to produce as much sulphur trioxide as possible per day. It makes no sense to try to achieve an equilibrium mixture which contains a very high proportion of sulphur trioxide if it takes several years for the reaction to reach that equilibrium.

You need the gases to reach equilibrium within the very short time that they will be in contact with the catalyst in the reactor.

The compromise

400 - 450°C is a compromise temperature producing a fairly high proportion of sulphur trioxide in the equilibrium mixture, but in a very short time.

The pressure

Equilibrium considerations

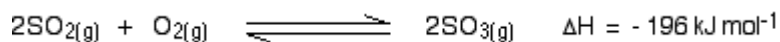

Notice that there are 3 molecules on the left-hand side of the equation, but only 2 on the right.

According to Le Chatelier's Principle, if you increase the pressure the system will respond by favouring the reaction which produces fewer molecules. That will cause the pressure to fall again.

In order to get as much sulphur trioxide as possible in the equilibrium mixture, you need as high a pressure as possible. High pressures also increase the rate of the reaction. However, the reaction is done at pressures close to atmospheric pressure!

Economic considerations

Even at these relatively low pressures, there is a 99.5% conversion of sulphur dioxide into sulphur trioxide. The very small improvement that you could achieve by increasing the pressure isn't worth the expense of producing those high pressures.

The catalyst

Equilibrium considerations

The catalyst has no effect whatsoever on the position of the equilibrium. Adding a catalyst doesn't produce any greater percentage of sulphur trioxide in the equilibrium mixture. Its only function is to speed up the reaction.

Rate considerations

In the absence of a catalyst the reaction is so slow that virtually no reaction happens in any sensible time. The catalyst ensures that the reaction is fast enough for a dynamic equilibrium to be set up within the very short time that the gases are actually in the reactor.

TOPIC 13 – CARBONATES, LIMESTONE AND LIMESTONE CYCLE

Limestone is still used to build houses but is mainly now used by industry to make a large number of products which are shown in the LIME CYCLE below.

THE LIME CYCLE – IMPORTANT CHEMICALS FROM LIMESTONE

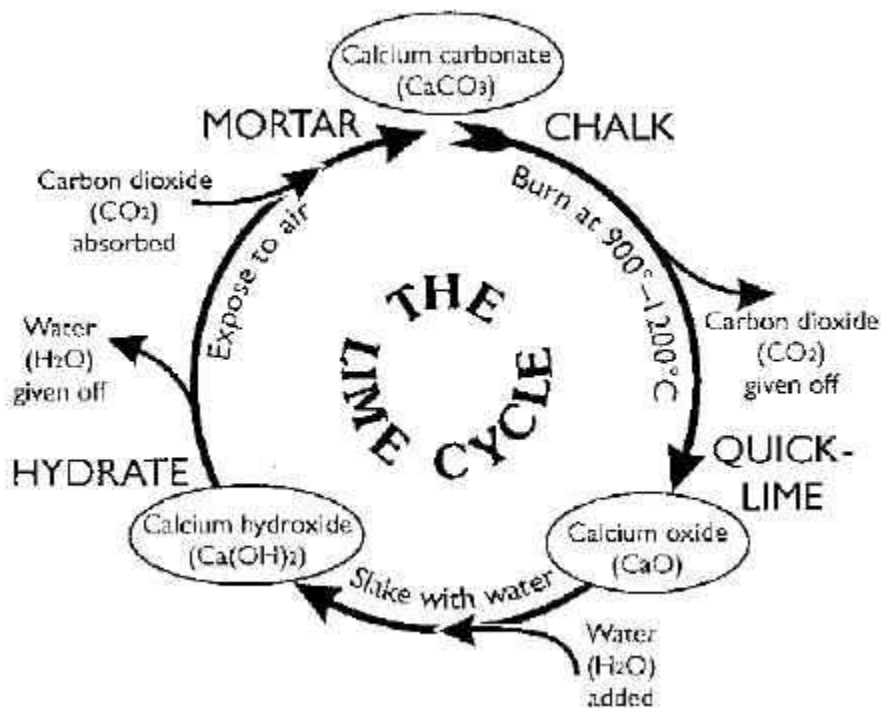

For hundreds of years, limestone has been heated in a kiln or furnace to make QUICKLIME or CALCIUM OXIDE (CaO).

LIMESTONE HEATED AT 1200°C = QUICKLIME + CARBON DIOXIDE



This is an example of THERMAL DECOMPOSITION (BREAKDOWN OF A SUBSTANCE BY HEAT).

When water is added to quicklime, there is a very fast exothermic reaction (produces heat) and SLAKED LIME (CALCIUM HYDROXIDE) FORMS.

CALCIUM OXIDE + WATER = SLAKED LIME

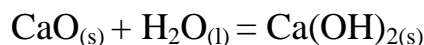

Slaked lime is an ALKALI. This is the basis for many of its uses. The major uses of the products of the limestone cycle – LIMESTONE, QUICKLIME AND SLAKED LIME are shown below.

USES OF LIMESTONE – CALCIUM CARBONATE - CaCO_3

1. Crushed and used as an AGGREGATE for road building
2. Added as a powder to lakes to NEUTRALIZE ACIDITY
3. Mixed with clay to make CEMENT
4. Used to extract iron from iron ore in the BLAST FURNACE
5. Heated with soda and sand to make GLASS
6. Used to NEUTRALIZE ACID GASES LIKE SULPHUR DIOXIDE produced by power stations.

USES OF QUICKLIME – CALCIUM OXIDE – CaO

1. Added to soil to NEUTRALIZE ACIDITY
2. Used in MAKING STEEL from iron
3. Used as a DRYING AGENT in industry

USES OF SLAKED LIME – SOLID CALCIUM HYDROXIDE – Ca(OH)_2

1. Added to soil to NEUTRALIZE ACIDITY
2. Used as a MORTAR in building
3. Used to make POTTERY
4. As a solution it is called LIME WATER. It turns MILKY with CARBON DIOXIDE GAS.

TOPIC 14 – FINAL TOPIC – ORGANIC CHEMISTRY

Organic Chemistry - Introduction

(1) Structural formulae :

As well as using a normal type of molecular formula to describe an organic molecule, they can be represented by drawing out their structure *i.e.* by showing how the atoms are connected, or **bonded**, to each other.

In order to do this a few rules have to be followed -

- (i) carbon atoms must be bonded four times;
- (ii) oxygen atoms must be bonded twice;
- (iii) hydrogen atoms must bond only once.

ethane :	$\begin{array}{c} \text{H} \quad \text{H} \\ \quad \\ \text{H}-\text{C}-\text{C}-\text{H} \\ \quad \\ \text{H} \quad \text{H} \end{array}$
ethene :	$\begin{array}{c} \text{H} \quad \quad \text{H} \\ \diagdown \quad / \\ \text{C}=\text{C} \\ / \quad \quad \diagdown \\ \text{H} \quad \quad \text{H} \end{array}$
ethanol :	$\begin{array}{c} \text{H} \quad \text{H} \\ \quad \\ \text{H}-\text{C}-\text{C}-\text{O}-\text{H} \\ \quad \\ \text{H} \quad \text{H} \end{array}$
ethanoic acid :	$\begin{array}{c} \text{H} \quad \quad \text{O} \\ \quad \quad // \\ \text{H}-\text{C}-\text{C} \\ \quad \quad \diagdown \\ \text{H} \quad \quad \text{O}-\text{H} \end{array}$

(2) Homologous Series :

A **homologous series** is a group of organic compounds with similar chemical properties and structural formula and a gradual change in physical properties *e.g.* melting point and boiling point.

Below is a graph of boiling point against number of carbon atoms for the various homologous series covered in JP organic :

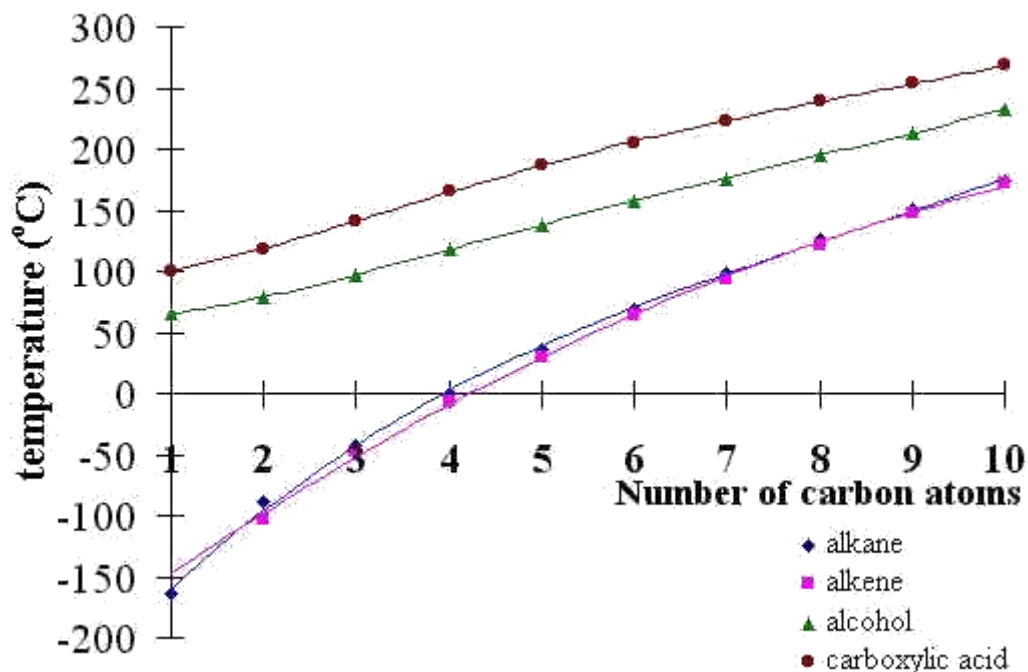

From the graph above, it can be seen that as the number of carbon atoms in the organic compound increases the boiling points increase.

Also, the boiling points tend to follow a straight line with the higher members of each group *i.e.* the difference between boiling points tends towards a single value.

The four homologous series studied at IGCSE are **alkanes**, **alkenes**, **alcohols** and **carboxylic acids**. The names and formulae of these compounds will be dealt with in separate sections.

The members of each series differ from each other by the number of carbon atoms contained in the molecule,

alkane				
alkene				
alcohol				
carboxylic acid				

Organic Chemistry - Alkanes

(1) Names :

Alkanes are the simplest homologous series of compounds and their names follow this pattern,

CH_4 - **methane**

C_2H_6 - **ethane**

C_3H_8 - **propane**

C_4H_{10} - **butane**

C_5H_{12} - **pentane**

i.e. they have a prefix (meth-, eth-, prop-, but-, etc..) which depends on the number of carbon atoms in the molecule and a common suffix (-ane).

The general chemical formula for an alkane is C_nH_{2n+2} .

Branched alkanes -

When the alkane is not just a simple straight chain of carbon atoms joined together the names become a little more complex.

The longest connected chain of carbon atoms must be found as before and the alkane name generated as usual.

Then the name for the pendent group is found, again by counting the number of carbon atoms present, and used as a prefix.

CH_3 - group : *methyl*_____

CH_3CH_2 - group : *ethyl*_____

$CH_3CH_2CH_2$ - group : *propyl*_____

$CH_3CH_2CH_2CH_2$ - group : *butyl*_____

The numbers used to indicate the positions of the pendent groups must be the lowest numbers possible, so always check them from both ends of the molecule.

Example -

3-ethylpentane :

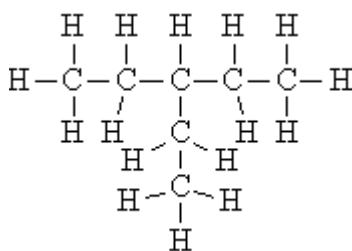

Some examples to try out -

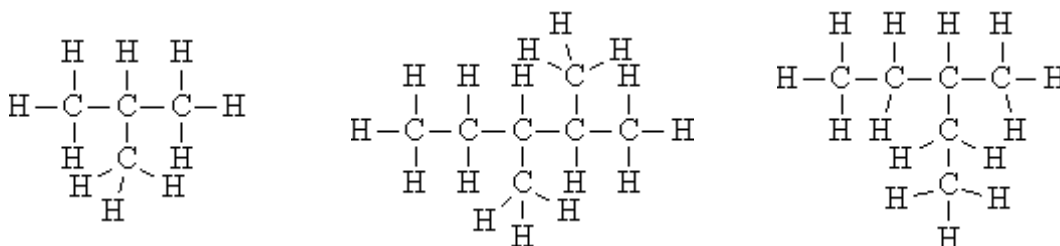

(2) Reactions of alkanes :

(i) Combustion -

Alkanes, **along with all other types of hydrocarbon**, will burn in an excess of oxygen to give **carbon dioxide** and **water only** as the products,



in general,



If there is not enough oxygen present then instead of carbon dioxide, **carbon monoxide**, **CO**, is produced. Carbon monoxide is particularly toxic and absorbed into blood, through respiration, very easily. For domestic heating systems it is particularly important that enough air can get to the flame to avoid carbon monoxide being generated in the home. Car engines also require a lot of air and there is a lot of research going on to make the internal combustion engine more efficient, and so put out less carbon monoxide.

Note also that both alkanes and carbon dioxide are **green house gases**, *i.e.* they trap infra-red (i.-r.) radiation inside the Earth's atmosphere, gradually increasing global temperatures.

(ii) Halogenation -

The only other reaction that an alkane will undergo is a reaction with a halogen (chlorine or bromine typically) with UV light present as an initiator of the reaction,

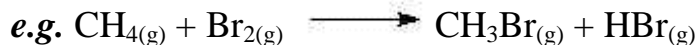

The UV light causes the formation of **free radical** halogen atoms by providing enough energy for the bond between the two halogen atoms to break.

A halogen atom attacks the alkane, **substituting** itself for a hydrogen atom. This **substitution** may occur many times in an alkane before the reaction is finished.

A similar process occurs high up in the earth's atmosphere when CFC's and other organic solvents react with intense sunlight to produce free radicals, chlorine atoms in this case. These attack molecules of ozone (O_3) depleting ozone's concentration and leading to the "**holes**".

(3) Crude oil :

(i) Fractional distillation -

Crude oil is a mixture of many different hydrocarbon compounds, some of them liquid and some of them gases. These compounds can be separated because the different length of alkanes will have different boiling points.

The crude oil is heated up to about $350\text{ }^\circ\text{C}$ and is fed into a fractionating column, as in the diagram below,

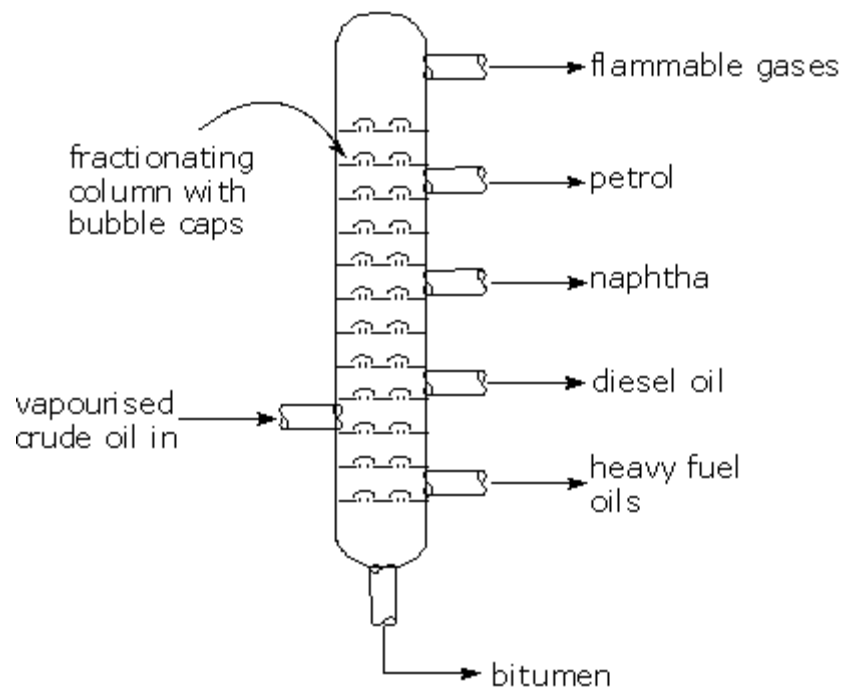

The vapours with the lowest boiling points pass all the way up the column and come off as **gases**, *e.g.* methane, ethane and propane. The temperature of the column gradually decreases the higher up the vapours go, and so various fractions will condense to liquids at different heights.

The fractions with the highest boiling points do not vaporize and are collected at the bottom of the fractionating column, *e.g.* bitumen

Here is a table with some boiling points for the commonest fractions :

<i>Fraction name</i>	<i>Boiling point (°C)</i>
Refinery gases	
Gasoline	
Naphtha	
Kerosene	
Diesel oil	
Fuel oil	
Bitumen	

(ii) Cracking -

In industry the fractions obtained from the fractional distillation of crude oil are heated at high pressure in the presence of a catalyst to produce shorter chain alkanes and alkenes.



(iii) Reforming -

This is a process where straight chain alkanes are turned into branched alkanes and cyclic alkanes are turned into aromatic compounds.

Both these reactions result in the formation of chemicals that improve the performance of fuels as well as enable more exotic compounds to be made.

Organic Chemistry - Alkenes

(1) Names :

Alkenes all have a C=C double bond in their structure and their names follow this pattern,

C_2H_4 - **ethene**

C_3H_6 - **propene**

C_4H_8 - **butene**

C_5H_{10} - **pentene**

The general chemical formula for an alkene is C_nH_{2n} .

(2) Addition reactions of alkenes :

(i) Bromination -

The double bond of an alkene will undergo an **addition reaction** with aqueous bromine to give a dibromo compound. The **orange** bromine water is **decolourised** in the process.

e.g. ethene reacts with bromine water to give 1,2-dibromoethane,

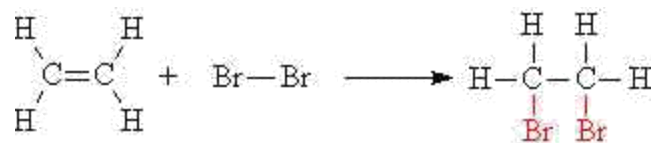

(ii) Hydrogenation -

Alkenes may be turned into alkanes by reacting the alkene with hydrogen gas at a high temperature and high pressure. A nickel catalyst is also needed to accomplish this addition reaction.

e.g. ethene reacts with hydrogen to give ethane,

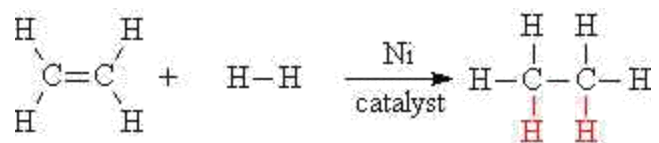

This reaction is also called **saturation** of the double bond. In ethene the carbon atoms are said to be **unsaturated**. In ethane the carbon atoms have the maximum number of hydrogen atoms bonded to them, and are said to be **saturated**.

(iii) Oxidation -

The carbon-carbon double bond may also be oxidised *i.e.* have oxygen added to it. This is accomplished by using acidified potassium manganate(VII) solution at room temperature and pressure. The **purple** manganate(VII) solution is **decolourised** during the reaction.

e.g. ethene reacts with acidified potassium manganate(VII)_(aq) to give ethan-1,2-diol,

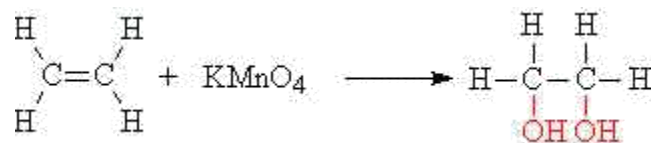

(3) Addition polymerisation :

All alkenes will react with free radical initiators to form **polymers** by a **free radical addition** reaction.

Some definitions -

monomer - a single unit *e.g.* an alkene.

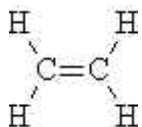

ethene

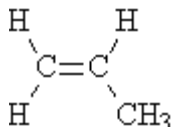

propene

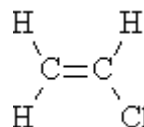

chloroethene

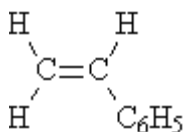

phenylethene

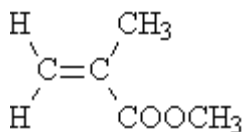

methyl methacrylate

The alkene monomer has the general formula :

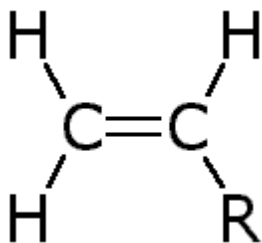

where R is any group of atoms, *e.g.* R=CH₃ for propene.

free radical initiator - a compound that starts a free radical reaction by producing radicals.

e.g. benzoyl peroxide or even oxygen

The reaction progresses by the separate units joining up to form giant, long chains -

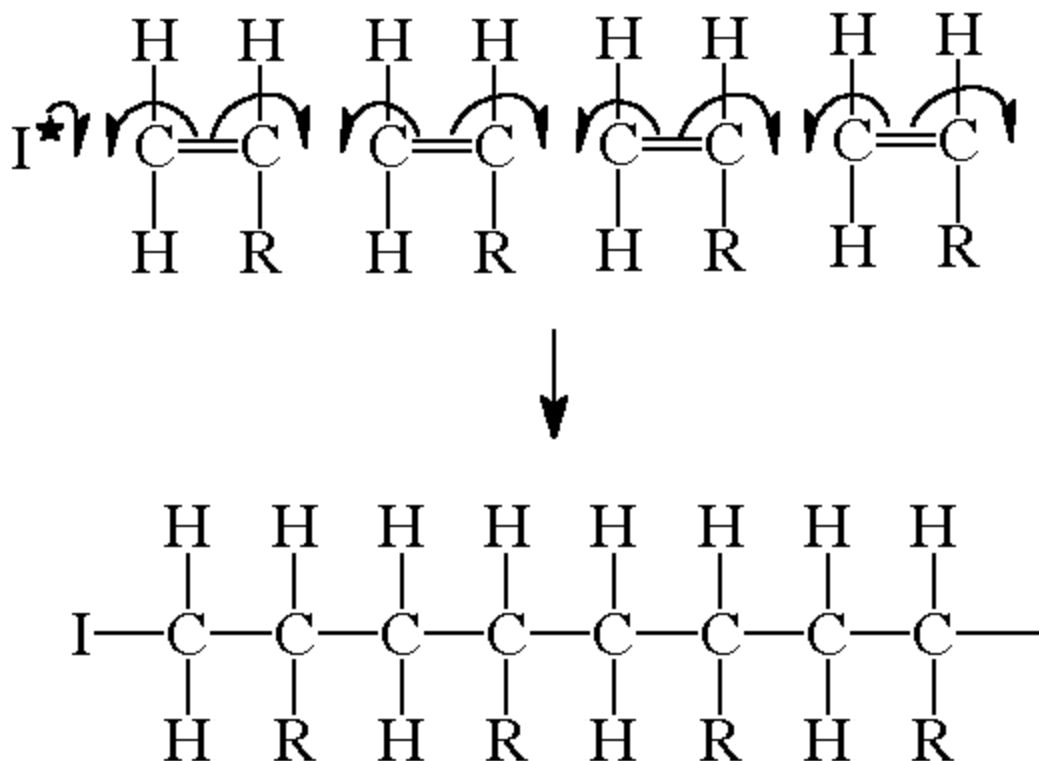

polymer - a material produced from many separate single monomer units joined up together.

An addition polymer is simply named after the monomer alkene that it is prepared from,

e.g. ethene makes poly(ethene)

propene makes poly(propene)

phenylethene makes poly(phenylethene)

chloroethene makes poly(chloroethene)

methyl acrylate makes poly(methyl acrylate)

The structure above shows just 4 separate monomer units joined together. In a real polymer, however, there could be 1000's of units joined up to form the chains. This would be extremely difficult to draw out and so the structure is often shortened to a **repeat unit**. There are 3 stages to think about when drawing a repeat unit for a polymer –

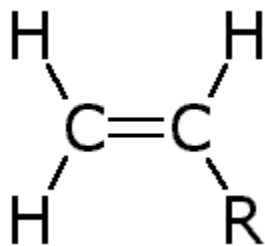

- 1) Draw the structure of the desired monomer :
- 2) Change the double bond into a single bond and draw bonds going left and right from the carbon atoms :
- 3) Place large brackets around the structure and a subscript *n* and there is the repeat unit.

where R= H for ethene

= CH₃ for propene

= C₆H₅ for phenylethene

= Cl for chloroethene

= COOCH₃ for methyl acrylate

Polymer structure and properties -

When the individual alkene units join together to give a polymer they result in the formation of long chains of carbon atoms joined together. In any sample of a polymer there are many separate chains present. These chains will be of varying lengths, depending on the number of alkene units that make them up.

These separate chains entwine with one-another, much as cooked spaghetti does, forming weak attractions between the chains - but with no actual bonds between the chains,

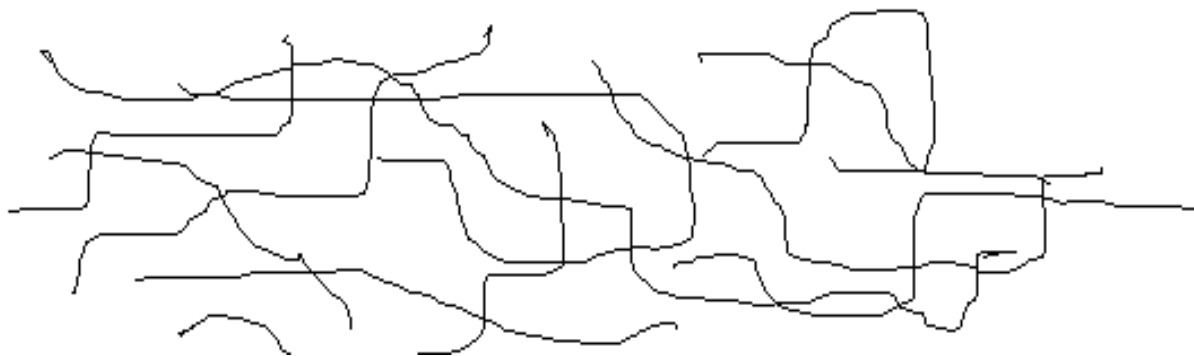

This arrangement of chains enables the polymer to have great flexibility, low density and an ability to be shaped and moulded when molten.

This type of polymer structure gives what is called a **thermosoftening polymer** - a polymer that may be melted, shaped and cooled many different times during its life.

There is another type of polymer structure though. If the individual chains are actually joined to one-another by a few covalent bonds. This gives greater strength and durability to the material,

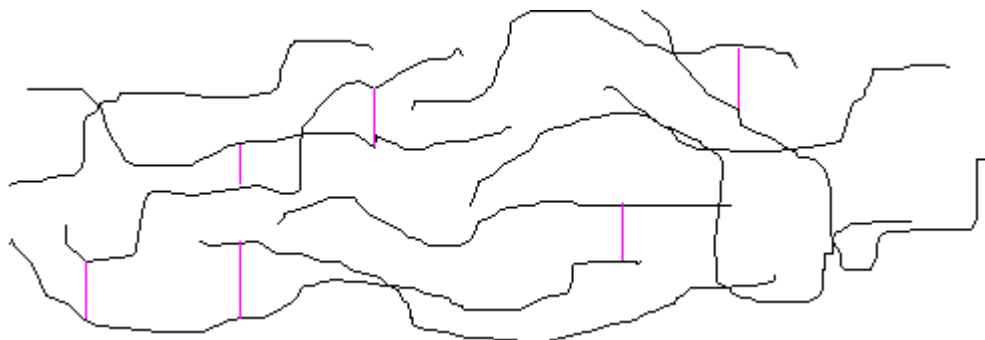

— = crosslink between chains

This rigidity means that once this type of polymer has been formed, the structure prevents the material from being melted. This is called a **thermosetting polymer** and will only char or burn when heated.

e.g. vulcanised rubber for car tyres
resins for gluing

Organic Chemistry - Alcohols

(1) Names :

Alcohols all have an -OH group and their names follow this pattern,

CH₃OH - **methanol**

C₂H₅OH - **ethanol**

C₃H₇OH - **propanol**

C₄H₉OH - **butanol**

C₅H₁₁OH - **pentanol**

The general chemical formula for an alcohol is **C_nH_{2n+1}OH**.

(2) Reactions of Ethanol :

(i) Preparation of ethanol by fermentation -

Ethanol is prepared in the laboratory and in the alcoholic drinks industry, by the process of **fermentation**. This involves the use of an **enzyme** (**yeast**) that changes a **carbohydrate**, **e.g.** sucrose, into ethanol and carbon dioxide gas,

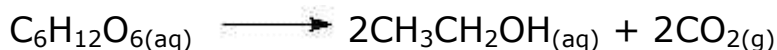

The yeast used requires a certain temperature to be active - somewhere between 15 and 37 °C. Too high a temperature and the yeast "dies" and too low a temperature causes the yeast to become dormant.

The production of carbon dioxide gas can be monitored by bubbling any gases produced during the reaction through limewater (calcium hydroxide_(aq)). The formation of a white precipitate (calcium carbonate) in the limewater shows that carbon dioxide has been given off.

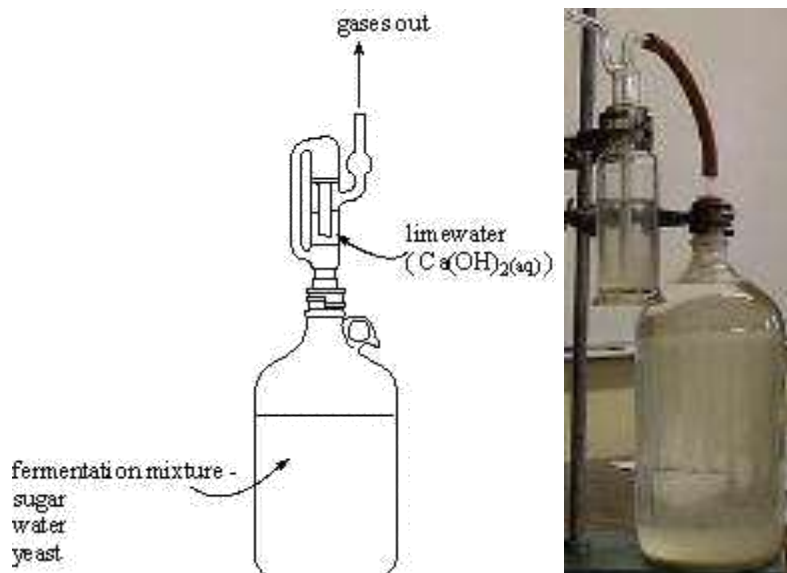

To obtain pure ethanol from the fermentation mixture, the process of fractional distillation must be carried out on the resulting solution. The equipment is shown below,

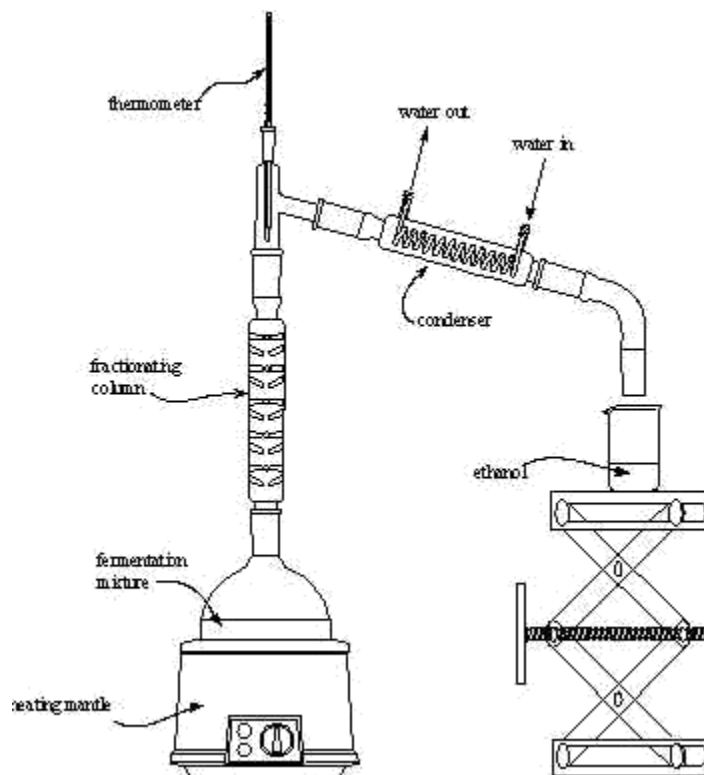

In a process similar to that of crude oil, the ethanol/water mixture can be separated by fractional distillation because of the difference in boiling points.

Ethanol boils at 79 °C and water boils at 100 °C, so that ethanol boils first and therefore comes over through the condenser first. The fractionating column allows the vapours to condense and drop back down into the round-bottom flask, stopping water vapour from passing through into the condenser

(ii) Dehydration of ethanol -

Experimental sheet for the dehydration of ethanol.

All alcohols contain hydrogen and oxygen (as well as carbon) and these atoms can be removed from an alcohol as a molecule of water (H₂O). This type of reaction is called **dehydration**. It can be accomplished by passing alcohol vapour over a heated **aluminium oxide** catalyst.

e.g. ethanol can be turned into ethene,



(iii) Oxidation of ethanol -

Experimental sheet for the oxidation of ethanol.

Oxidation can be defined as the **addition of oxygen** to a substance. This can be accomplished with alcohols by the use of acidified potassium dichromate(VI)_(aq). This turns the alcohol into a carboxylic acid.

e.g. ethanol can be turned into ethanoic acid,



(3) Uses of Ethanol :

Ethanol is used in alcoholic drinks; as a solvent, *e.g.* methylated spirits; and as an alternate to petrol or diesel, especially in California.

Organic Chemistry - Carboxylic acids

(1) Names :

Carboxylic acids all have the -COOH structural group in them and their names follow this pattern,

HCOOH - **methanoic acid**

CH₃COOH - **ethanoic acid**

C₂H₅COOH - **propanoic acid**

C₃H₇COOH - **butanoic acid**

C₄H₉COOH - **pentanoic acid**

The general chemical formula for a carboxylic acid is **$C_nH_{2n-1}OOH$** .

(2) Esterification

The Esterification of Ethanol to Ethyl Ethanoate

Introduction

Apart from the normal reactions of acids, such as reactions with metals and bases, ethanoic acid (along with all the carboxylic acids) will react with ethanol (or other alcohols) to give ethyl ethanoate (an **ester**) in a simple process.

Diagram -

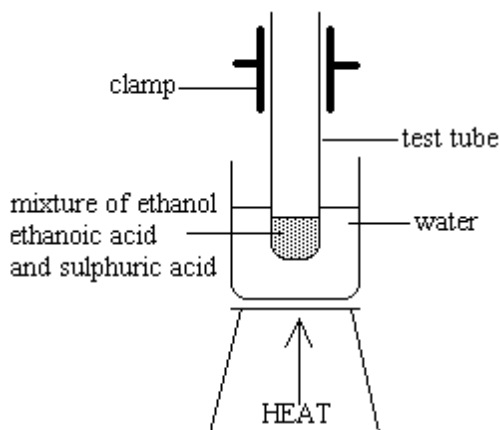

Method

Set up a boiling tube in a beaker of cold water as in the diagram above. Add about a few cm's depth of ethanol followed by another cm of ethanoic acid from a bottle. Then **carefully** add a few drops of concentrated sulphuric acid (**CARE: very dangerous**) to the boiling tube. Add an anti-bumping granule or two, and heat up the water bath until the reaction mixture in the boiling tube starts to boil gently. Keep the reaction boiling gently for about 15 minute. Then raise the boiling tube out of the water bath and leave to cool.

Carefully add some sodium or calcium carbonate to the boiling tube until no more fizzing is produced. Filter the solution and carefully smell the clear liquid remaining.

Note down all your observations during this reaction.

Carboxylic acids will react with alcohols to produce organic compounds called **esters**.

e.g. ethanoic acid and ethanol will produce ethyl ethanoate,



Some **concentrated sulphuric acid** is added to act as a catalyst for the reaction. It removes the water produced in the reaction, thus helping the reaction to produce more products.

Esters are used as flavourings and perfumes in all sorts of materials.

(3) Condensation polymerisation :

As well as the addition polymers formed from alkenes and free radical initiators already mentioned, there is another method of preparing long chain polymers.

This second method of polymerisation relies on the reaction between a dicarboxylic acid and an dialcohol (or a diamine) and is called **condensation polymerisation** since water is released during the formation of the polymer chains.

A monocarboxylic acid will react with an alcohol to give an ester (see equation above).

If a molecule had two carboxylic acid groups on it, one at each end, and it reacted with a molecule with two -OH groups on it then many ester groups, *i.e.* a polyester, would be formed and long chains produced –

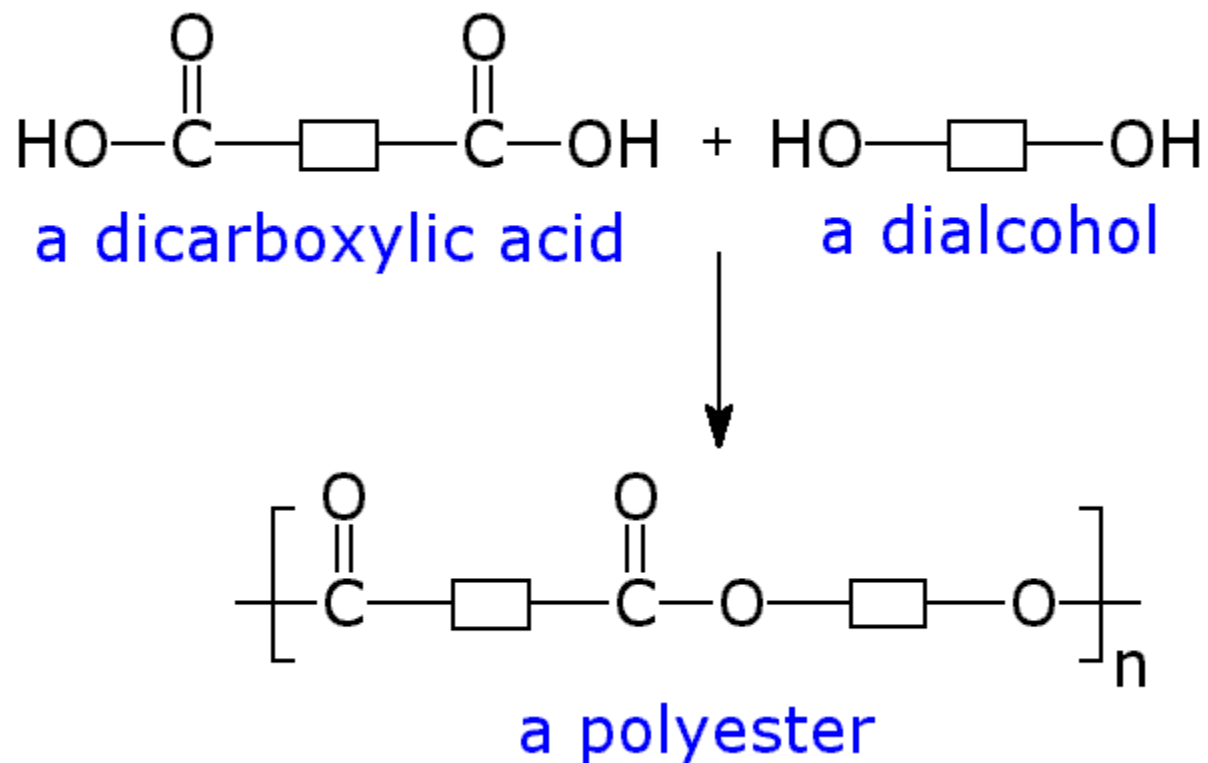

where the boxes represent any group of atoms.

If the dialcohol is replaced by a diamine then a **polyamide** or **nylon** is formed -

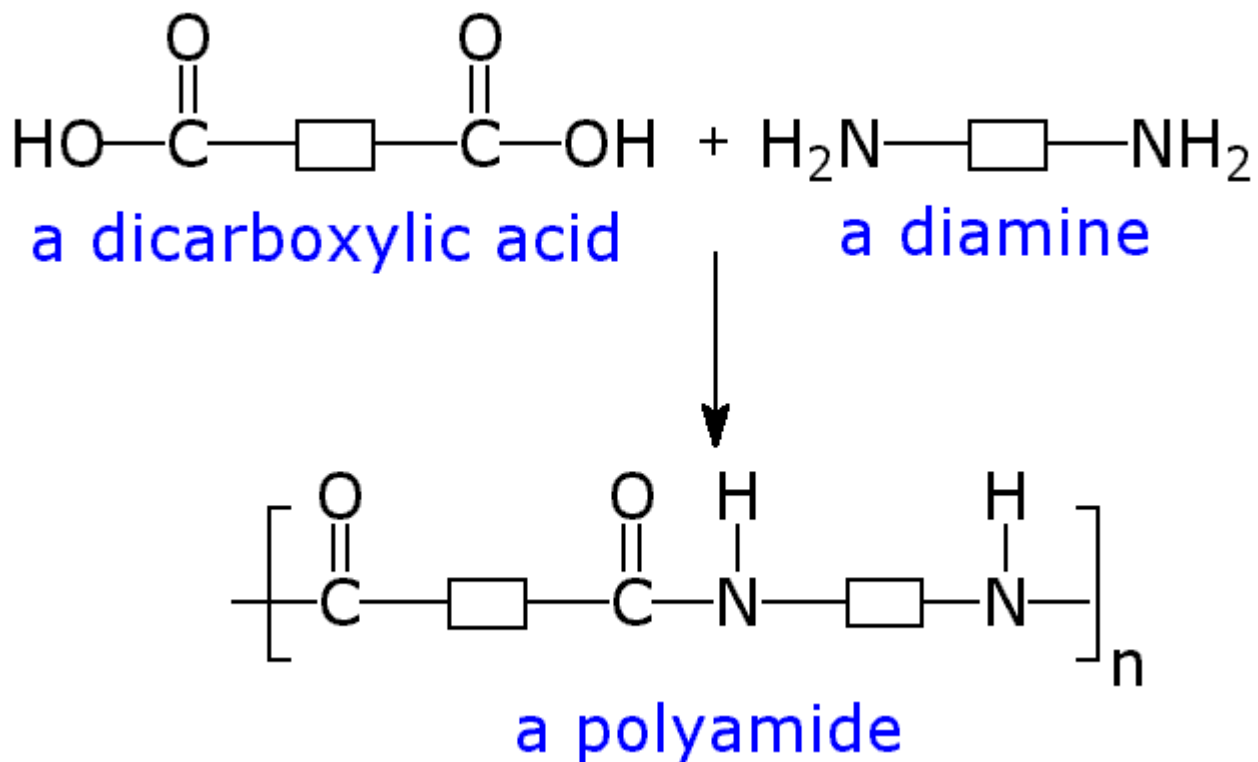

(4) Natural condensation polymers :

The above picture encompasses only the synthetic part of the organic work. There are a number of natural polymers required. These are :

(i) Fats :

These natural materials contain the ester link found in the synthetic polyesters shown above.

They may be **hydrolysed** (broken down) by a reaction with sodium hydroxide (a strong **base**) and heat.

Once hydrolysed they form **soaps** (sodium salts of carboxylic acids) and glycerol (propan-1,2,3-triol).

(ii) Proteins :

These naturally occurring materials contain the amide link found in the synthetic polyamides shown above.

These compounds may also be **hydrolysed** by a reaction with enzymes and/or aqueous acid. Proteins in the food we ingest are broken down by stomach acids and enzymes which work at body temperature.

Once hydrolysed they form **amino acids** which can then be used by the human body to prepare vital chemicals needed to sustain life.

(5) Saponification :

Saponification means "soap-making" and is a reaction in which a fat, or oil, is turned into a salt of a carboxylic acid.

The oil is heated with a concentrated solution of a caustic base, such as sodium hydroxide. The base breaks down the ester links, forming alcohol groups and carboxylate ion groups on different molecules.

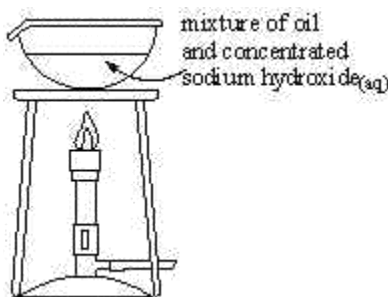

FINALLY – BEFORE WE GO

THE FINAL PAGE SUMMARIZES ALL THE REACTIONS IN ORGANIC CHEMISTRY AT IGCSE.

BEST OF LUCK WITH YOUR STUDIES. YOU DESERVE TO DO WELL

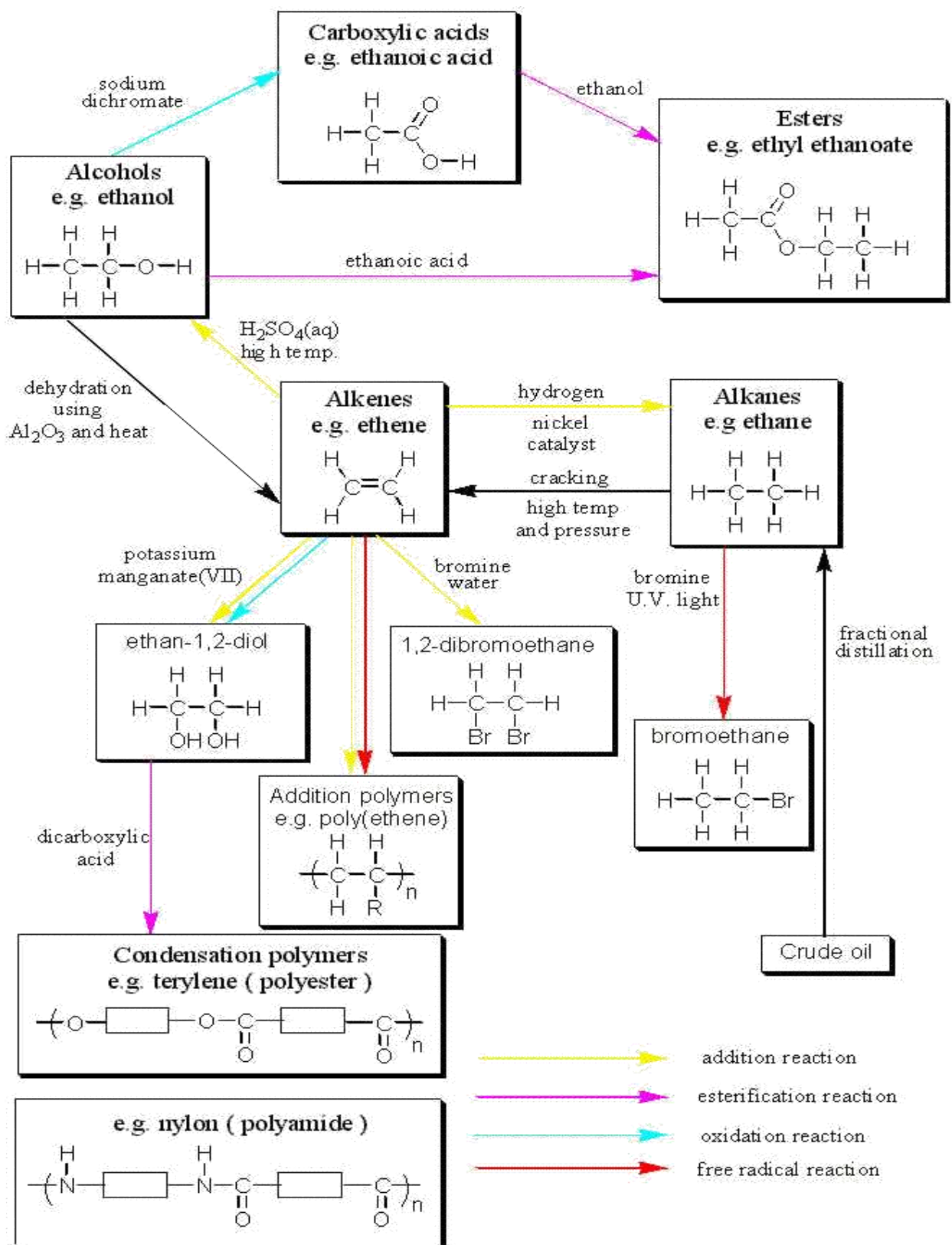

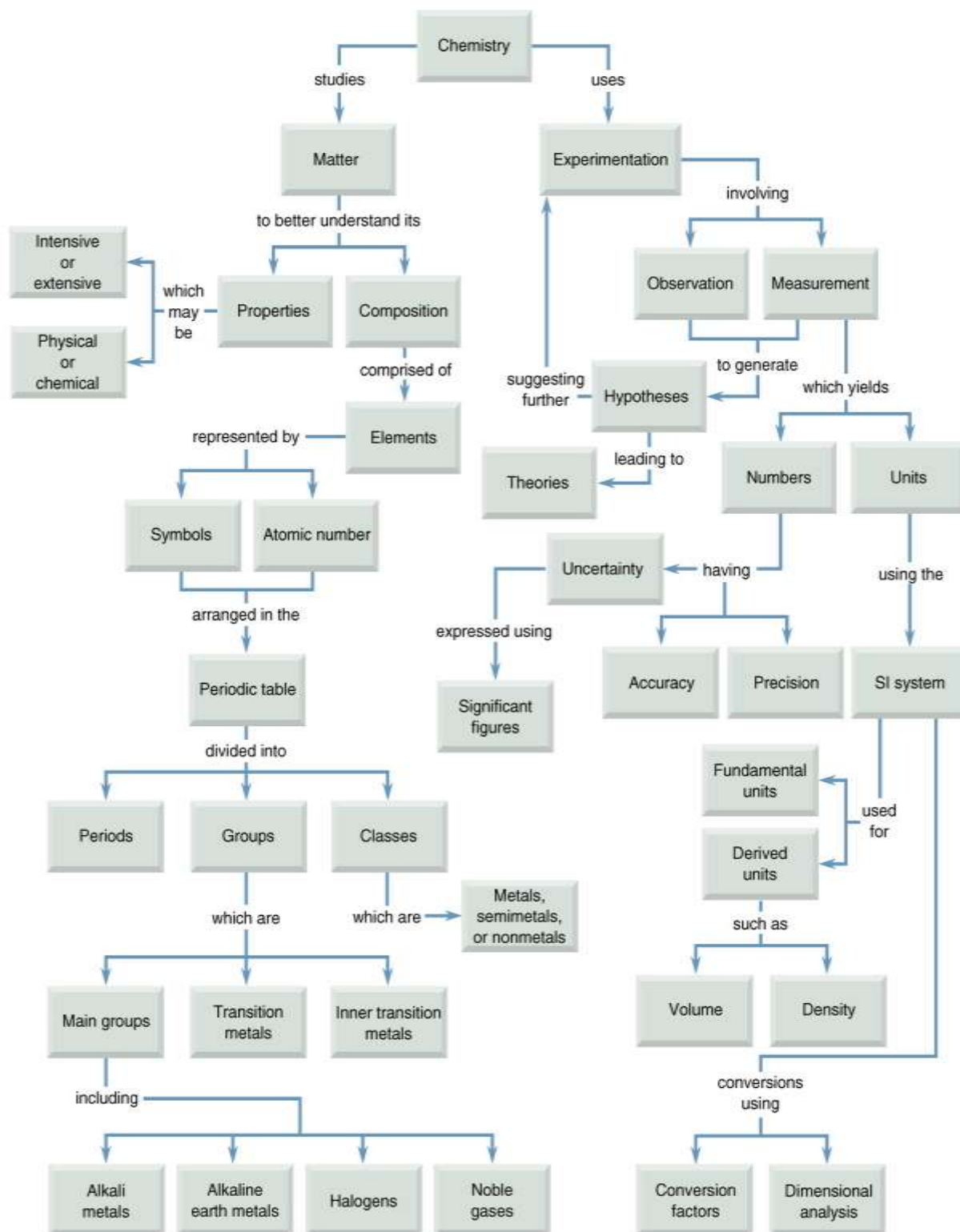

THIS FLOWCHART SUMMARIZES WHAT CHEMISTRY IS!!!!