

IGCSE Chemistry 2012 exam revision notes

by Samuel Lees

Contents:

1. [The particulate nature of matter](#)
2. [Experimental techniques](#)
 - 2.1 [Measurement](#)
 - 2.2 (a) [Criteria of purity](#)
 - 2.2 (b) [Methods of purification](#)
3. [Atoms, elements and compounds](#)
 - 3.1 [Atomic structure and the Periodic Table](#)
 - 3.2 [Bonding the structure of matter](#)
 - 3.2 (a) [Ions and ionic bonds](#)
 - 3.2 (b) [Molecules and covalent bonds](#)
 - 3.2 (c) [Macromolecules](#)
 - 3.2 (d) [Metallic bonding](#)
4. [Stoichiometry](#)
 - 4.2 [The mole concept](#)
5. [Electricity and chemistry](#)
6. [Chemical energetics](#)
 - 6.2 [Energetics of a reaction](#)
 - 6.3 [Production of energy](#)
7. [Chemical reactions](#)
 - 7.2 [Speed of reaction](#)
 - 7.3 [Reversible reactions](#)
 - 7.4 [Redox](#)
8. [Acids, bases and salts](#)
 - 8.2 [The characteristic properties of acids and bases](#)
 - 8.3 [Types of oxides](#)
 - 8.4 [Preparation of salts](#)
 - 8.5 [Identification of ions and gases](#)
9. [Periodic table](#)
 - 9.2 [Periodic trends](#)
 - 9.3 [Group properties](#)
 - 9.4 [Transition elements](#)
 - 9.5 [Noble gases](#)
10. [Metals](#)
 - 10.1 [Properties of metals](#)
 - 10.2 [Reactivity series](#)
 - 10.3 (a) [Extraction of metals](#)
 - 10.3 (b) [Uses of metals](#)
11. [Air and water](#)

- 12 [Sulphur](#)
- 13 [Carbonates](#)
- 14 [Organic chemistry](#)
- 14.1 [Names of compounds](#)
- 14.2 [Fuels](#)
- 14.3 [Homologous series](#)
- 14.4 [Alkanes](#)
- 14.5 [Alkenes](#)
- 14.6 [Alcohols](#)
- 14.7 [Acids](#)
- 14.8 [Macromolecules](#)
- 14.8 (a) [Synthetic polymers](#)
- 14.8 (b) [Natural molecules](#)

-stuff in blue is not on the syllabus but it might help you to understand to know those things, or is an example question (in the stoichiometry section)

-the section titles are underlined and in **bold** and in size 14. The sub-sections are only underlined and in **bold**.

-words in red are the ones which you have to know the definition of.

1. The particulate nature of matter

Kinetic Theory:

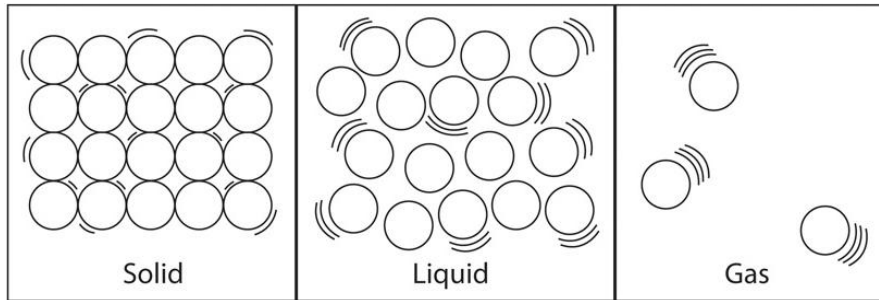

All substances are made of atoms, which consist of protons, electrons and neutrons.

States of matter:

Solid:

1. Strong forces of attraction between particles
2. Have a fixed pattern (lattice)
3. Atoms vibrate but can't change position therefore fixed volume and shape

Liquid:

1. Weaker attractive forces than solids
2. No fixed pattern, liquids take up the shape of their container but have a fixed volume
3. Particles slide past each other.

Gas:

1. Almost no intermolecular forces
2. Particles are far apart, and move quickly
3. They collide with each other and bounce in all directions.

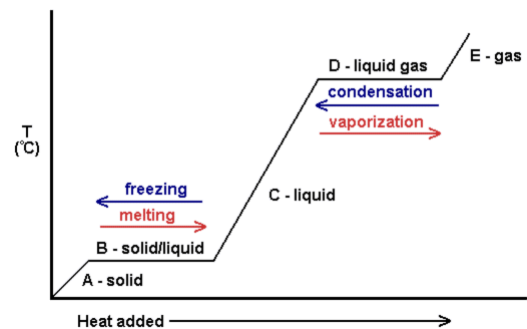

Changes of state:

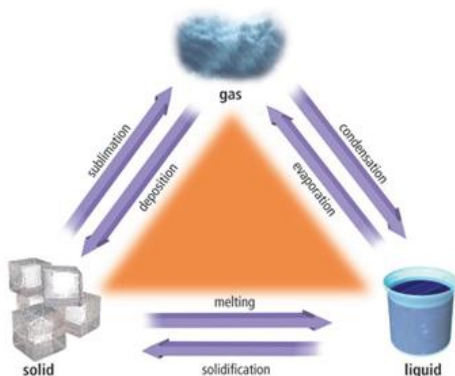

Condensation and solidification: condensation is when a gas turns back into a liquid. When a gas is cooled, the particles lose energy. They move more and more slowly. When they bump in to each other, they do not have enough energy to bounce away again. They stay close together, and a liquid forms. When a liquid cools, the particles slow down even more. Eventually they stop moving except for vibrations and a solid forms.

Evaporation and boiling: evaporation constantly occurs on the surface of liquids. The high energy particles escape from the liquid, even at low temperatures. Boiling occurs at the boiling point (I bet you did not know that) and then the liquid evaporates everywhere in the liquid (not just on the surface) and is much faster. During a change of state the temperature of the mixture does not change.

Diffusion: the process in which particles mix/spread by colliding randomly with each other, and bouncing off in all directions. Particles travel in random zigzag motions, this is how smells spread, solids dissolve, dust particles travel in a random way when suspended in air.

Evidence for diffusion:

In liquids: potassium manganate (VII) in a beaker of water. (The colour will spread as a result of Brownian/random motion, this is dissolving.)

In gases: a gas jar of air and a gas jar of bromine are connected, the bromine travels up the tube.



Factors that affect the rate of diffusion:

Temperature increases → rate of diffusion increases

Particle mass decreases → rate of diffusion increases and vice versa (this is shown by the following experiment):

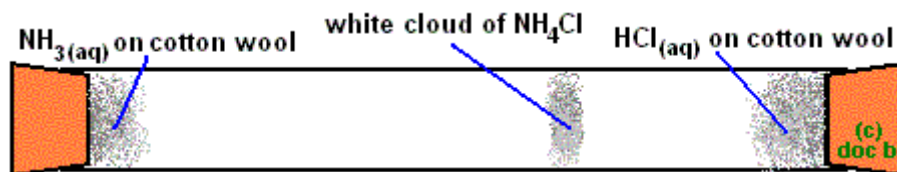

Dissolving can be sped up by increasing temperature or stirring

2. Experimental techniques

2.1 Measurement

Variable	Time	Temperature	Mass	Volume
Apparatus	Stopwatch Clock	Thermometer (liquid in glass, thermistor or thermocouple)	Balance	-beaker (a) -burette (b) -pipettes (c) -measuring cylinder (d) -gas syringe

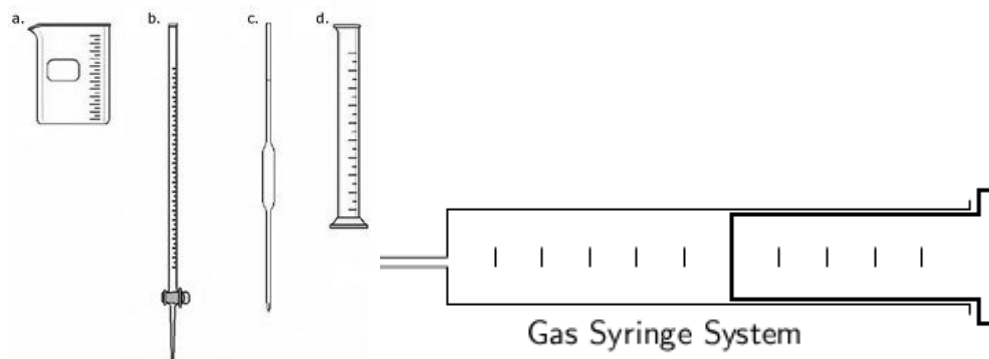

2.2 (a) Criteria of purity

Paper chromatography: (To separate substances) a drop of the substance is placed at the centre of a piece of filter paper and allowed to dry. Three or four more drops are added to it. Water is dripped on, drip by drip, so the ink spreads creating different coloured circles. Paper + rings = **chromatogram**. Rings are created because different substances travel at different rates. (To identify substances) Spots of substances placed onto a pencilled line (as ink would separate) which is called the **origin**, and labelled. Paper goes in solvent, and solvent travels up paper, then paper is taken out. There are spots which have travelled different distances.

-**Interpreting** simple chromatograms:

1. Number of rings/dots = number of substances
2. If two dots travel the same distance up the paper they are the same substance.
3. You can calculate the **R_f value** to identify a substance, given by the formula:

$$R_f \text{ value} = \frac{\text{distance moved by substance}}{\text{distance moved by solvent}}$$

To make colourless substances visible you use a **locating agent**: 1. Dry paper in oven 2. Spray it with locating agent 3. Heat it for 10 minutes in oven.

The **stationary phase** is the material on which the separation takes place (e.g. the paper).

The **mobile phase** consists of the mixture you want to separate, dissolved in a solvent.

Measuring Purity:

Pure substances have a definite, sharp melting/boiling point; a substance + impurity has **lower melting point** and **higher boiling point**, at a range of temperatures; more impurity means bigger change. This is why salt is used on roads to prevent the formation of ice or to melt ice.

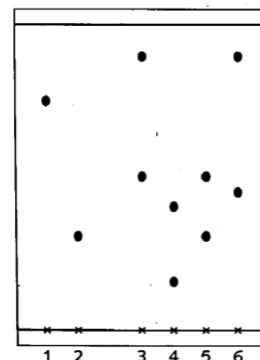

Purity is important in drugs and foodstuffs, they cannot contain harmful substances.

2.2 (b) Methods of purification

-Filtration: Mixture goes in a funnel with filter paper, into a flask. Residue is insoluble and stays at top. Filtrate goes through.

Crystallisation: Some water in the solution is evaporated so the solution becomes more concentrated. One drop is placed on a microscope slide to check if crystals are forming. The solution is left to cool and crystallise. Crystals are filtered to remove solvent.

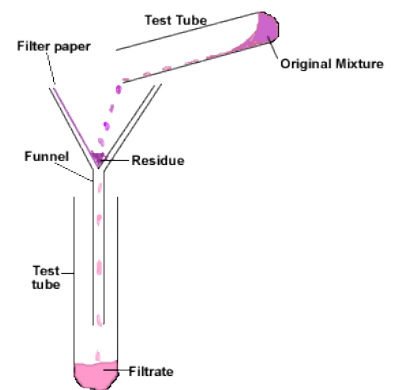

4 By crystallising

You can obtain many solids from their solutions by allowing them to form crystals. Copper(II) sulphate is an example:



This is a saturated solution of copper(II) sulphate in water at 70 °C. If it is cooled to 20 °C...

... crystals begin to appear, because the compound is *less soluble* at 20 °C than at 70 °C.

The process is called **crystallisation**. It is carried out like this:



1 A solution of copper(II) sulphate is heated, to get rid of some water. As the water evaporates, the solution becomes more concentrated.

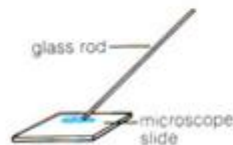

2 The solution can be checked to see if it is ready by placing one drop on a microscope slide. Crystals should form quickly on the cool glass.

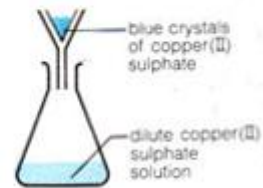

3 Then the solution is left to cool and crystallize. The crystals are removed by filtering, rinsed with water and dried with filter paper.

Distillation:

Simple distillation (left picture below) **evaporates** a solvent from a solution.

Fractional distillation (right picture below) removes a liquid from a mixture of liquids, because the liquids have different boiling points. Used to separate substances in crude oil and get ethanol from the products of fermentation.

1. mixture is heated to evaporate the substance with the lowest boiling point
2. some of the other liquid(s) will evaporate too. A mixture of gases condense on the beads in the fractional column. So the beads are heated to the boiling point of the lowest substance in this case, so that the substance being removed cannot condense on the beads. The other substances continue to condense and will drip back into the flask. The beaker can be changed after every fraction.

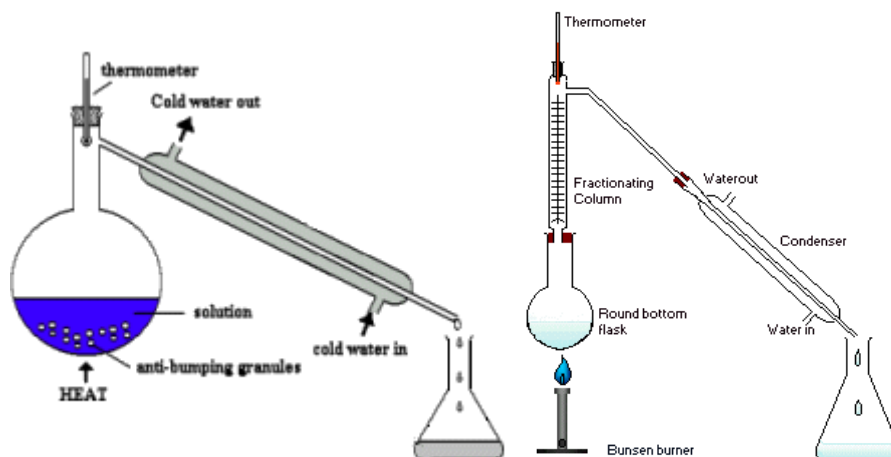

Using a suitable solvent:

Solvent	It dissolves
water	see " Soluble salts ", sugar
white spirit	gloss paint
propanone	grease, nail polish
ethanol	glues, printing inks , scented substances in perfumes and aftershaves

Choosing a suitable separation method:

Method of separation	Used to separate
filter	a solid from a liquid
evaporate	a solid from a solution
crystallise	a solid from a solution
distil	a solvent from a solution
fractional distillation	liquids from each other
chromatography	different substances from a solution

3. Atoms, elements and compounds

3.1 Atomic structure and the Periodic Table

Particle	Relative charge	Mass (atomic mass units)
Proton	+1	1
Neutron	0	1
Electron	-1	1/1840

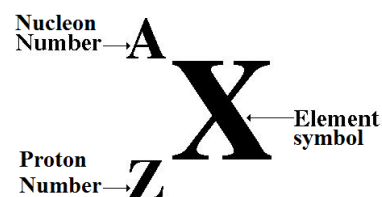

Proton number: the number of protons in an atom (and the number of electrons in an uncharged atom).

Nucleon number: the number of protons + neutrons in an atom.

In the periodic table, when you go one element to the right, you increase the proton number by 1. When you go one element down, you increase the proton number by 8 in the first 3 periods (where the transition elements are not included).

Isotope: atoms of the same element that have different numbers of neutrons e.g. Carbon 12 and Carbon 14.

There are **non-radioactive isotopes** and **radio(active)-isotopes**. Radio isotopes are unstable atoms, which break down giving radiation.

Medical use: cancer treatment (radiotherapy) – rays kill cancer cells using cobalt-60.

Industrial use: to check for leaks – radioisotopes called tracers are added to oil or gas. At the leaks radiation is detected using a Geiger counter, (if you need to name an element then say carbon 14 – used for carbon dating, when something dies it does not take in new carbon atoms, but it still has remaining carbon-14 atoms, the radiation can be measured to estimate how long ago something died).

Electrons are arranged in **electron shells**. Atoms want to have full outer shells (full set of **valency electrons**), this is why they react. Noble gases have full outer shells so they have no need to react. Electron shell structure: 2, 8, 8, 18. More reactive elements have a greater desire to have a full outer shell, so also form more stable compounds.

3.2 Bonding: the structure of matter

Element: a substance that cannot be split into anything simpler, in a chemical reaction. Each element has a unique proton number.

Mixture: two or more elements mixed together BUT that are not chemically combined

Compound: a substance in which two or more different elements are chemically combined.

Metals:

1. strong
2. malleable and ductile
3. sonorous
4. good conductors of heat and electricity
5. have high melting and boiling points (except mercury)
6. high density
7. react with oxygen to form (usually) basic compounds called metal oxides (aluminium oxide is amphoteric)
8. in reactions they form positive ions (cations)
9. some, e.g. iron, are magnetic.

Non metals:

1. Are brittle
2. Have lower melting and boiling points than metals
3. Poor conductors of electricity, except for graphite (carbon) and are also bad conductors of heat
4. Have low densities
5. Most react with oxygen to form (usually) acidic oxides (carbon monoxide is neutral)
6. Form negatively charged ions (anions) in a chemical reaction

Alloy: a mixture where at least one other substance is added to a metal, to improve its properties; the other substance is often a metal too (but not always) e.g. brass (70% copper and 30% zinc) is harder than copper, does not corrode, used in musical instruments.

3.2 (a) Ions and ionic bonds

Ion: is a charged atom (i.e. number of protons does not equal number of electrons). They form by losing an electron (**reduction**) increases charge by 1, or by gaining one (**oxidation**) decreases charge by 1. Remember OIL RIG: oxidation is loss, reduction is gain. A positively charged atom is called a **cation**, it is usually a metal. A negatively charged atom is called an **anion**, it is a non-metal(s).

Ionic bond: the bond formed between ions of opposite charge.

Group 1 metals react with halogens. In the reaction the metal gives one electron to the halogen, as shown below (NOTE the way the ions are represented using brackets and + and – signs)

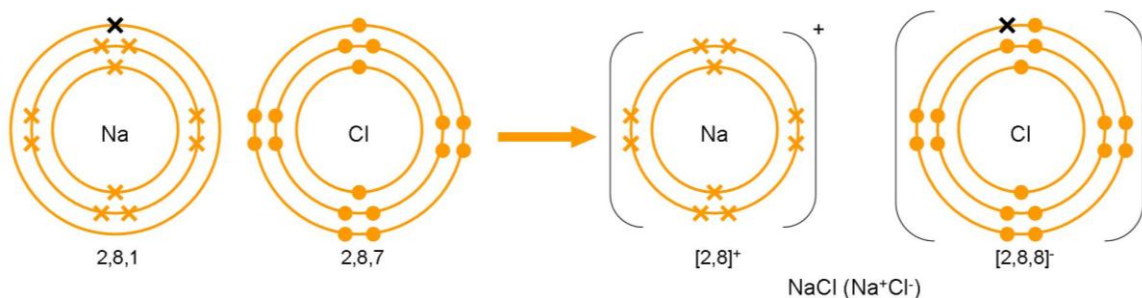

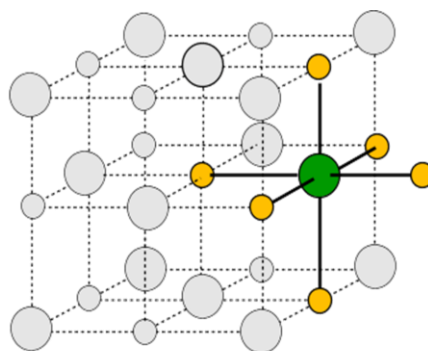
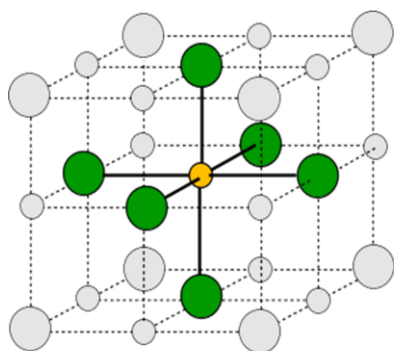

**EACH SODIUM ION IS SURROUNDED BY SIX CHLORIDE IONS
EACH CHLORIDE ION IS SURROUNDED BY SIX SODIUM IONS**

In a reaction a metal gives a non-metal its valency electrons.

An ionic compound (in solid state) has a regular arrangement (lattice) of alternating positive and negative ions.

3.2 (b) Molecules and covalent bonds

Single covalent bond: a bond where 2 non-metals share a pair of electrons to get full-outer shells as seen in H₂, Cl₂, H₂O, CH₄ and HCl represented by a line connecting the two symbols e.g. H-H

Double bond is when 4 electrons are shared (two from each atom) and a triple bond is when 6 are shared (3 from each atom) e.g. C=C and N≡N

	Volatility (forms vapour)	Solubility	Electrical conductivity
Ionic compound	low	usually soluble	when molten or in solution
Covalent compound	high	the majority do not dissolve	none (except graphite)

Know how to draw the following structures: N₂, C₂H₄, CH₃OH, and CO₂

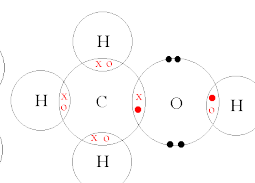
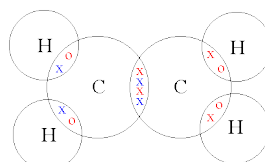
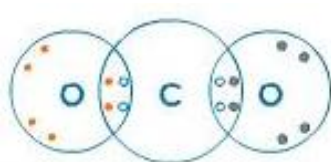
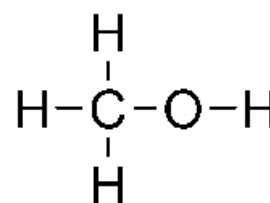
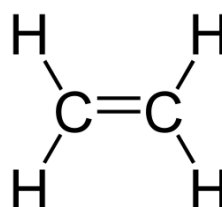

Important things to note: covalent bonds are weak, and ionic bonds are strong. When you melt an ionic solid you break up the compound into ions, so it takes more energy, therefore ionic compounds have higher melting points. When you melt a covalent solid, the molecules are broken up from each other but are still bonded (e.g. when you melt ice you get H₂O molecules but in a liquid, but melting NaCl gives you a molten mixture of Na⁺ and Cl⁻ ions).

3.2 (c) Macromolecules

Diamond: has four bonds, high melting point, does not conduct and is very hard. Used for cutting, because it is the hardest known substance (2 left pictures below).

Graphite: has three bonds, made of flat sheets that are held together by weak forces so it is soft and slippery, so it is used as a lubricant. It can conduct electricity because it has one free electron. It is slippery because the sheets have weak bonds between them (middle picture).

Silicon (IV) oxide/silicon dioxide/silica: makes up most of sand. Each Si atom is bonded to four oxygen atoms, and each oxygen atom is bonded to two silicon atoms. As a result it has a high melting point and is hard, like diamond (right picture).

Silicon IV oxide and diamond both have high melting points and are very hard substances.

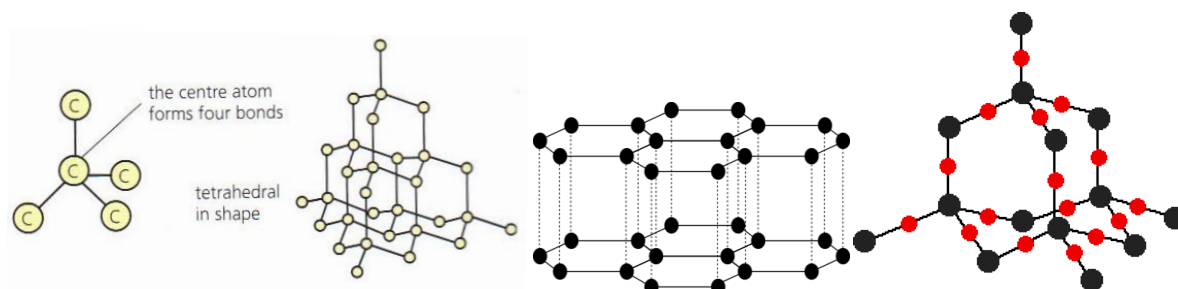

GENERAL PROPERTIES OF GIANT MOLECULES

MELTING POINT - Very high since structure is made up of a large number of covalent bonds, all of which need to be broken if atoms are to be separated

ELECTRICAL - Don't conduct electricity - have no mobile ions or electrons, BUT... Graphite conducts electricity

STRENGTH - Hard - exist in a rigid tetrahedral structure e.g. Diamond and silica (SiO_2)... but Graphite is soft

3.2 (d) Metallic bonding

-Metallic bonding: a lattice of tightly packed positive ions in a sea of electrons, resulting in crystals, therefore:

1. Metals are **malleable** and **ductile** – the layers of ions can slide over each other

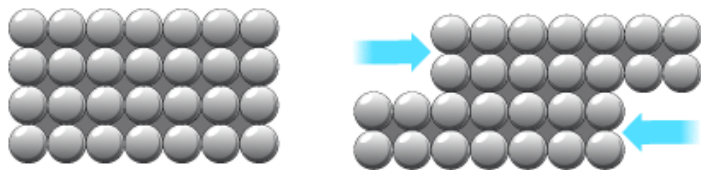

2. Metals are **good conductors** – free electrons take energy

4. Stoichiometry

-In a symbol equation the number of atoms on each side of the equation should be balanced for each element.

-In an equation, remember to write the symbol for the state (aqueous, solid, liquid, gas) in brackets, and the oxidation state of a transition metal in a word equation.

Relative atomic mass, A_r : the average mass of the atoms of an element, relative to the mass of an atom of carbon-12.

Relative molecular mass, M_r : the mass of a molecule, found by adding the relative atomic masses of the atoms in it, it is called the **relative formula mass** for an ionic compound.

Determining the name and formula of a compound:

To determine the formula of an ionic compound the positive charge must equal the negative charge.

Naming compounds:

If only two elements are combined, the name ends in '-ide'.

Exception: ammonia

With covalent bonds, Greek prefixes are used to denote the number of atoms

1 = mono	carbon mon oxide
2 = di	carbon di oxide
3 = tri	phosphorus tri hydride
4 = tetra	
5 = penta	

6 = hexa

The only time we drop a prefix is if the *mono* is to appear at the beginning of the name

If there is an oxide the 'a' or 'o' of the prefix is lost e.g. carbon **monoxide**

If a metal ion is combined with a polyatomic ion in a compound and one is oxygen, the name ends in *-ate*, except hydroxides

With ionic compounds, the cation (metal) goes first in the name.

With covalent compounds the element further on the left goes first (hydrogen is thought of being in between nitrogen and oxygen so: phosphorus trihydride / hydrogen peroxide)

4.1 The mole concept

A **mole** is the A_r or M_r expressed in grams e.g. 1 mole of Carbon-12 is equal to 12 grams. It is equal to 6.02×10^{23} atoms, this number is called **Avogadro's constant**. 1 mole of a gas at **RTP** (25°C and 1atm or room temperature and pressure) occupies a volume of 24dm^3 . The symbol for a mole is "mol" e.g. 1mol. Concentration is measured in mol/dm^3 or M for short.

Moles calculations:

(NOTE: when you read this say the "r" sign as "per" e.g. 12g/1mol is "12 grams per mole")

Grams to moles: number of grams $\times 1 / M_r$

Moles of one substance to another:

number of moles of substance A $\times \frac{\text{number of moles of substance B in balanced equation}}{\text{number of moles of substance A in balanced equation}}$

Moles back to grams: Number of moles \times (number of grams per mole e.g. 20g/mole)

Moles of gas to volume (at RTP): Number of moles $\times 24\text{dm}^3$

Gas volume to moles: volume / 24dm^3

Moles to atoms: Number of moles $\times 6.02 \times 10^{23}$

Volume to moles: volume \times concentration (concentration=moles of solute/total volume)

Percent purity = amount of wanted substance / total amount of substance $\times 100\%$

Percent yield = actual yield / theoretical yield $\times 100\%$

Empirical formula: simplest ratio of atoms in the chemical formula.

Molecular formula: the formula using the actual number of atoms in a molecule.

To find out the empirical formula you:

-make the percent ratio into the simplest whole number ratio (NOTE: if it is percent mass, then you have to divide each percentage by its A_r to convert the mass ratio to an atom ratio (because atoms have different weights) then make that ratio into the smallest whole number ratio by dividing the coefficients of each element symbol by the lowest coefficient, for example:

1. A substance is 40% carbon, 6.6666% hydrogen and 53.3334% oxygen by mass.

First you must convert the mass ratio (40:6.6666:53.3334) to an atom ratio:

2. $40/12 = 3.3333 \rightarrow C_{3.3333}$

3. $6.6666/1 = 6.6666 \rightarrow H_{6.6666}$

4. $53.3334/16 = 3.3333 \rightarrow O_{3.3333}$

5. The ratio is $C_{3.3333} H_{6.6666} O_{3.3333}$

6. Just by looking we can see there are twice as many hydrogen atoms in the formula as either oxygen or carbon, but let us suppose that the ratio wasn't so easy to simplify, you would then have to:

7. Convert moles of carbon to the simplest whole number: $3.3333 / 3.3333 = 1$

8. Convert moles of hydrogen to the simplest whole number: $6.6666 / 3.3333 = 2$

9. Convert moles of oxygen to the simplest whole number: $3.3333 / 3.3333 = 1$

10. The ratio is therefore 1:2:1 so the empirical formula is CH_2O

-simplify the molecular formula

for example take $\text{C}_6\text{H}_{12}\text{O}_6$ and divide each coefficient by the smallest number (6) $\rightarrow \text{CH}_2\text{O}$

-if you are given the masses of each element in the compound you divide the masses by the A_r , and convert into the simplest whole number ratio.

To calculate the molecular mass:

-if you have the empirical formula you know the empirical mass as well. Then if you are given the molecular mass you just do molecular mass/empirical mass to give you "n". Then you multiply the empirical ratio by "n".

Now let's suppose that they tell you the molecular mass of the compound that has the empirical formula CH_2O is 180, and you are asked to find the molecular formula

1. Find out the empirical mass: $12 + (2 \times 1) + 16 = 30$

2. Find the number you must multiply the empirical formula by, let's call it 'n': $180 / 30 = n = 6$

3. Multiply the empirical ratio by 6 $\rightarrow 1:2:1 \times 6$ is 6:12:6

4. The molecular formula is therefore $\text{C}_6\text{H}_{12}\text{O}_6$

The **limiting reagent** is the reactant that is in shorter supply than the other reactant (taking into account the number of moles of each reactant in the balanced equation) which will stop the chemical reaction. To find out which is the limiting reagent you convert the amounts of reactant if it is in grams, volume etc. into moles. Then you find out how many moles of product will form with that many moles of reactant by using the balanced equation. Whichever reactant will produce the least number of moles of product is the limiting reagent.

For example take this equation:



Let's say you have 30dm^3 of sulphuric acid with a concentration of $1\text{mol}/\text{dm}^3$, and 2.8 kilograms of KOH

$2.8\text{kg} \times 1000\text{g}/1\text{kg} \times 1\text{mol}/(39+1+16)\text{g} = 50\text{mol}$ of KOH

$50\text{mol} \times 1\text{molK}_2\text{SO}_4 / 2\text{molKOH} = 25\text{mol}$ of K_2SO_4 produced

$30\text{dm}^3 \times 1\text{mol}/\text{dm}^3 = 30\text{mol}$ of sulphuric acid

$30\text{mol} \times 1\text{molK}_2\text{SO}_4 / 1\text{mol H}_2\text{SO}_4 = 30\text{mol}$ of potassium sulphate produced

Potassium hydroxide is the limiting reagent.

5. Electricity and chemistry

Using inert electrodes (platinum or carbon)

Electrolyte	Product at cathode	Product at anode
lead (II) bromide (l)	lead	bromine
concentrated HCl (aq)	Hydrogen	Chlorine
concentrated NaCl (aq)	Hydrogen	chlorine

In general, metals or hydrogen are formed at the cathode (negative electrode, where reduction takes place), non-metals except hydrogen are formed at the anode (positive electrode, where oxidation takes place).

How to predict products: (FYI they will only give compounds with 2 elements like water, but no more i.e. not CuSO_4)

-if molten compound (e.g. iron oxide) then you just get the two components produced in elemental form (e.g. molten iron + oxygen gas)

-in a solution, at the cathode, the less reactive of the two positive ions will be reduced e.g. aqueous NaCl will produce hydrogen, not sodium.

-if a halide is in a concentrated solution, then a halogen will be produced at the anode. If the solution is dilute, oxygen, from the water, will be produced.

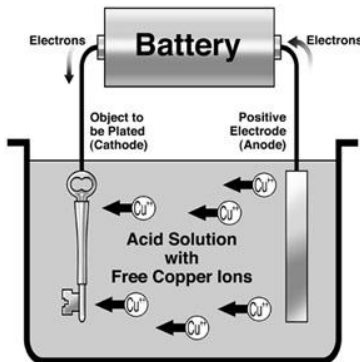

Electroplating (picture on the left)

For electroplating, you need:

- an anode made of the metal that you want to electroplate the object with,
- ions of the same metal as the anode in solution
- object to be plated at cathode

It is used to make things look better (coating a watch with gold) or to prevent corrosion.

Aluminium is used for electricity cables (not wires) because it is light, does not corrode, is a good conductor, and cheaper and much lighter than copper. The cables have a steel core, for strength. Plastics and ceramics are used as insulators because they do not conduct electricity, and conduct heat poorly. Plastic is used for

the casing in electric plugs. Ceramics (inorganic, non-metallic solids) are used to support the cables in electricity pylons. Copper is used in electrical wires (not cables) as it is a very good conductor and ductile (not as good a silver, which is the best conductor used in circuitry in keyboards, phones etc., but it is cheaper)

Choice of electrodes can affect products. An example:

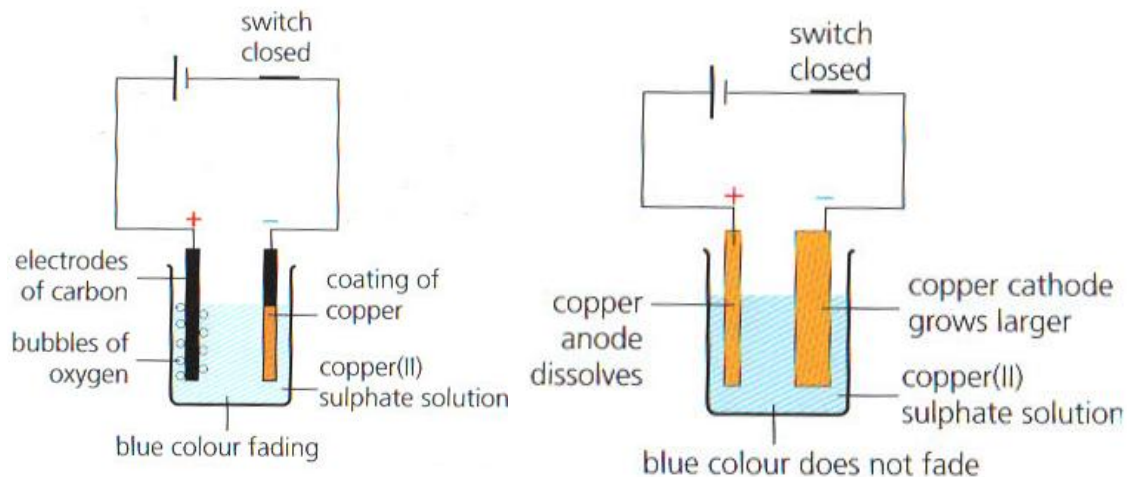

Electrolyte	Cathode made of:	Anode made of:	Product at cathode:	at anode:
dilute copper (II) sulphate	inert material	copper	copper	Nothing but Copper is lost
dilute copper (II) sulphate	inert material	inert material	copper	oxygen

This concept is used to refine copper

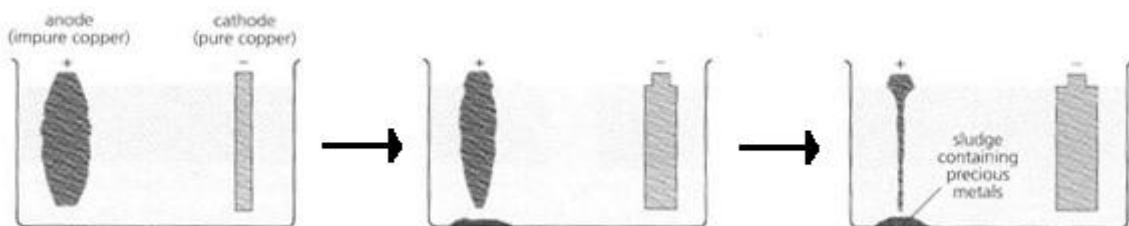

Electrolysis is a way to decompose compounds, using electricity. Reduction of positive cations happens at the cathode (CATions at CATHode. Oxidation of negative anions happens at the anode (ANions at ANode) for example:

At the anode: $2\text{Cl}^- \rightarrow \text{Cl}_2 + 2\text{e}^-$

At the cathode: $2\text{H}^+ + 2\text{e}^- \rightarrow \text{H}_2$

Extraction of aluminium and electrolysis of brine

Aluminium (III) oxide (alumina) is dissolved in molten **cryolite** (Na_3AlF_6). The mixture melts at a lower temperature. better conductor / reduces amount of energy needed / reduces cost / more economic / makes process viable / conserves energy

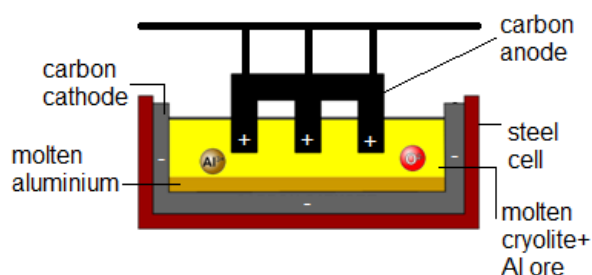
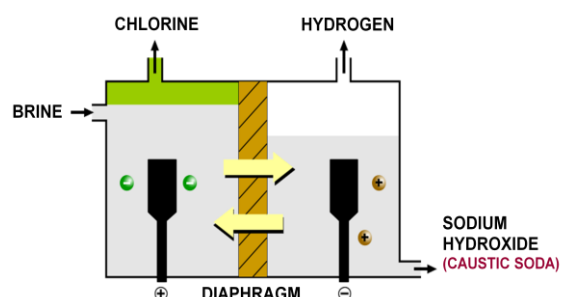

During electrolysis aluminium is produced at the carbon cathode and oxygen at the carbon anode.

Electrolysis of Brine

Brine is concentrated NaCl solution

Chlorine (making PVC, medical drugs, pesticides, sterilising water, making chemicals) is produced at the **titanium anode**, hydrogen (making nylon, make hydrogen peroxide, hardening vegetable oils, fuel) is produced at the **steel/nickel cathode** (in the book it says steel in the text and nickel in the diagram) and sodium hydroxide (soaps, detergents, medical drugs, dyes, paper, ceramics) is left over.

Asbestos diaphragm lets ions pass through, but keeps gases apart.

6. Chemical energetics

6.1 Energetics of a reaction

Exothermic reaction: gives out energy to the surroundings.

Endothermic reaction: takes in energy from the surroundings.

Bond breaking is endothermic

Bond making is exothermic

If you subtract the energy stored in the bonds of the reactants from the product you get the **change in enthalpy** or ΔH .

A positive ΔH occurs in an endothermic reaction (since products have more energy stored in their bonds)

A negative ΔH occurs in an exothermic reaction (since reactants have more energy stored in their bonds)

The **bond energy** is the amount of energy needed to break bonds, or released when the bonds form in kJ/mole

for example the bond energy of a H-H is 436kJ/mol so it takes that much energy to break that bond

if energy in – energy out > 0 the reaction is endothermic

if energy in – energy out < 0 the reaction is exothermic

6.2 Production of energy

A **fuel** is a substance used to obtain energy. Burning fuels (like oil, coal etc.) to form oxides is an exothermic reaction (gives out heat). The heat from burning fuels is used in power plants to create steam from water and turn turbines.

Hydrogen: Burns explosively with oxygen, so it is used in rockets. But in a **fuel cell** it combines with oxygen without burning (details of the construction and operation of a fuel cell are **not** required).

Nuclear fuels: are not burned. The radioisotopes (unstable atoms) decay naturally giving out energy. In a nuclear power station they are forced to break down by shooting neutrons at them. They heat up water to make steam which turns turbines.

Advantages: lots of energy is made from a small amount of fuel and no carbon dioxide is produced.

Disadvantage is that it produces radiation and radioactive waste, non-renewable

Electrochemical cell: consists of a negative pole (the more reactive metal) and a positive pole (less reactive metal) and an electrolyte. The greater the difference in reactivity of the two metals, the greater the voltage will be. The electrons flow because one metal is more reactive, so it has a stronger drive to give up its electrons. The atoms give up electrons and enter the solution as ions.

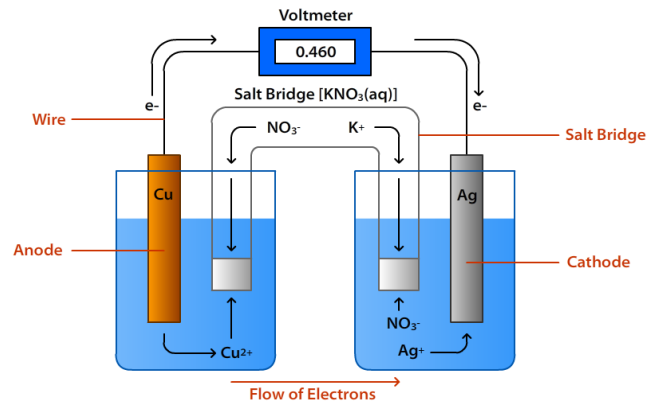
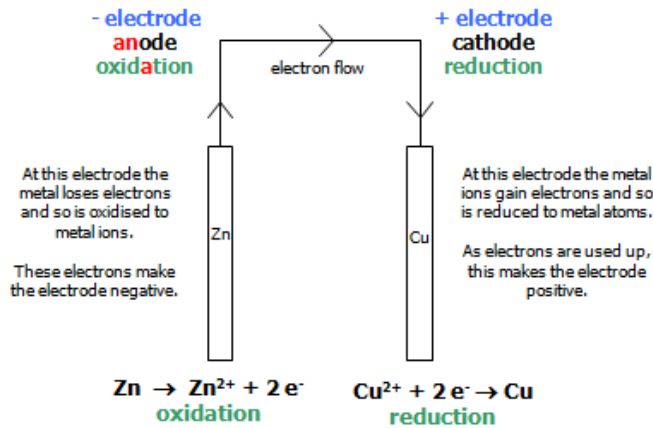

7. Chemical reactions

Collision theory: collisions are needed for a chemical reaction to take place & the successful collisions have enough energy, also known as activation energy, at the moment of impact to break the preexisting bonds and form all new bonds.

7.1 Speed of reaction

Factors affecting the rate of reaction are:

-Concentration (pressure in gases): the higher the concentration of reactants is (higher pressure in gases) the faster the reaction will happen. This is because there is more chance of reactant particles colliding, so there will be more collision per unit of time.

-Particle size: For the same mass of particles (e.g. 1kg) the smaller the particles are the faster the reaction will take place. This is because many small particles will have more surface area than fewer large particles. More surface area means that there is more area in which particles can collide. More collisions per unit of time means a faster reaction.

-Catalysts (including enzymes: biological catalysts): catalysts are substances which speed up reactions, whilst remaining chemically unchanged. Catalysts work by lowering the activation energy and providing an alternative pathway for the reaction. Reactions can take place with less energy.

Enzymes: proteins that function as biological catalysts

Factors that control how well enzymes work:

Temperature: enzymes have an **optimum temperature:** the temperature at which they work best giving the fastest reaction. In humans, most enzymes have an optimum temperature of 37°C, but in plants it is around 25°C. When temperature increases, the molecules move faster so collide with an enzyme in less time, having more energy makes them more likely to bind to the **active site:** the part of an enzyme where a specific substrate will fit perfectly. If the temperature is too high, the enzyme molecules vibrate too vigorously and the enzyme is **denatured:** it loses its 3D shape and will no longer bind with a substrate. When the temperature is too low there is not enough **kinetic energy** for the reaction so it reacts too slowly.

pH: The base or acid conditions can denature enzymes too, but the enzyme can be denatured if the pH is too low OR too high. Enzymes have an **optimum pH** too, for example amylase has an optimum pH of 7.5, and pepsin's is pH 2.

-Temperature: higher temperature speeds up reactions in two ways: 1) particles travel faster so they collide with other particles faster, so a reaction (which needs collisions) will take less time and 2) particles will more often overcome the activation energy.

Experiments:

1) Hydrochloric acid and sodium thiosulphate solution are mixed in a flask, and a stopwatch starts. They react forming sulphur which is insoluble in water so precipitates. The flask is on top of a cross drawn on a piece of paper. You measure the amount of time taken for the cross to not be visible because there is enough sulphur. The diameter of the cylinder should be kept constant (since that and the volume of reactants will control the depth of the mixture; deeper means that the cross will be invisible sooner). Variables that can be changed: temperature and concentration of reactants.

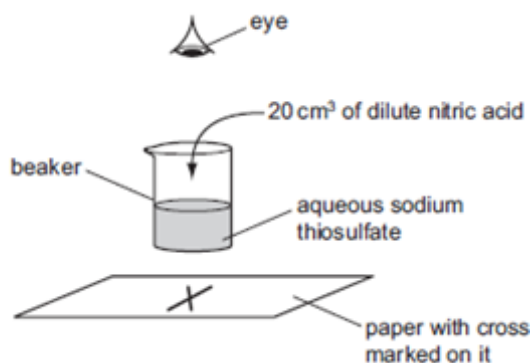

2) Reactions with different sized particles (e.g. magnesium powder vs. ribbon + acid, marble chips vs. smaller chips). Time taken for a certain amount of gas to be produced is measured, or change in mass, because the gas escapes (e.g. hydrogen for Mg + acid reaction, carbon dioxide for marble chip + acid experiment.) Marble is calcium carbonate. Interpret data: less time taken for a reaction means a faster rate; the reaction in terms of data can be a certain amount of gas produced or a change in mass etc.

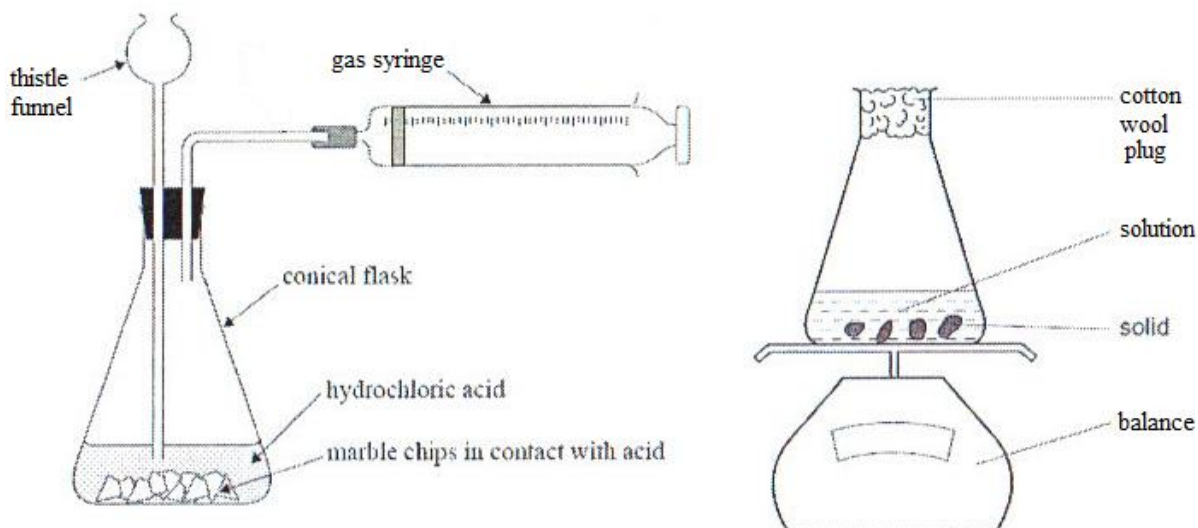

Large surface area can mean danger: Flour dust, wood dust, custard powder, instant coffee, sugar, and dried milk have large surface areas, and are combustible. A spark from a machine, or a lit match, can cause an explosion, this also applies to gases from mines (another syllabus specified example).

3) Fill a gas jar with a mixture of hydrogen and oxygen, and cover it. Even if you leave it for hours, no reaction will happen. Then dip a platinum wire into the mouth of the jar. The gas mixture explodes immediately with a pop, producing water.

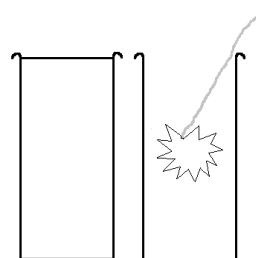

Light can affect the rate of reaction: **photochemical** reactions for example in photosynthesis. Light provides energy for the reaction, chlorophyll is a dye that absorbs light.

carbon dioxide + water \rightarrow (light + chlorophyll) \rightarrow glucose + oxygen



Silver salts in photographic film: Silver bromide breaks down, where light strikes the film, so silver is reduced. Silver ions are reduced to silver.

7.2 Reversible reactions

Reversible Reactions \rightleftharpoons : reactions which can go both ways, depending on the conditions.

Example: $\text{CuSO}_4 \cdot 5\text{H}_2\text{O}$ (blue) \rightleftharpoons CuSO_4 (white) + H_2O

(to get anhydrous you heat it, & to get the hydrated form, just add water)

There are two types of equilibrium: static and dynamic.

Dynamic equilibrium (FIY on the mock, these were the points you needed for the definition of equilibrium):

- Rate of forward reaction = rate of reverse reaction
- Concentrations of all reactants and products remain constant.
- The system is closed, and on the large scale (macroscopic) everything is constant.

If the **conditions** of an equilibrium are changed, the position of the equilibrium moves to oppose the change (this is known as **Châtelier's Principle**, if you know this, you can extrapolate how the conditions below will affect an equilibrium):

-**TEMPERATURE**: If the temperature is lowered – the equilibrium moves in the exothermic direction. If the temperature is raised – the equilibrium moves in the endothermic direction.

-**PRESSURE**: If the pressure is raised the equilibrium moves to reduce pressure, to the side with fewest gas molecules. If the pressure is lowered the equilibrium moves to the side with most gas molecules.

-**CONCENTRATION**: Decreasing reactant concentration or increasing product concentration moves equilibrium to the reactant side. Increasing reactant concentration or decreasing product concentration moves it to the product side.

NOTE CATALYSTS DO NOT CHANGE THE POSITION OF THE EQUILIBRIUM; THE REACTION JUST ARRIVES AT THE EQUILIBRIUM FASTER.

7.3 Redox

Oxidation Is Loss of electrons or the gain of oxygen, **Reduction Is Gain** of electrons or loss of oxygen. Remember OIL RIG.

Redox reaction is a reaction where reduction and oxidation happen, where there is electron transfer. Reduction and oxidation must happen together. One substance gives electron(s) to the other. In a redox reaction the substances will change **oxidation state** (their charge will change). Oxidation state is written using roman numerals when there is a transition metal in a word equation. **Reducing agents** are oxidised and **oxidising agents** are reduced. Oxidation state is written like this Iron(III) = Fe^{3+}

(a reaction where different atoms of the same element are reduced and oxidised is a disproportionation reaction)

Examples to know (page 111):

-potassium iodide will go from colourless to red-brown, it is a reducing agent, it therefore is oxidised to produce I_2

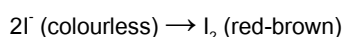
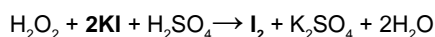

-Potassium manganate, an oxidising agent, will go from purple to colourless. (Recall of equations involving KMnO_4 is **not** required.)

-potassium dichromate, an oxidising agent: $\text{Cr}_2\text{O}_7^{2-}$ (orange) \rightarrow 2Cr^{3+} (green)

8. Acids, bases and salts

8.1 The characteristic properties of acids and bases

Acids turn blue litmus red.

Acids have a pH 6 and below (the syllabus says that pH values will be integers, no decimals)

Acid + metal \rightarrow metal salt + hydrogen

Acid + base (except carbonates) \rightarrow salt + water

Acid + metal carbonate \rightarrow metal salt + carbon dioxide + water

Bases turn red litmus blue.

Bases have a pH 8 to 14.

Acid + base \rightarrow salt + water + (carbon dioxide when the base is a metal carbonate)

All alkalis (except ammonia) will react with ammonium compounds, removing ammonia for example: calcium hydroxide + ammonium chloride \rightarrow calcium chloride + water + ammonia

Neutral substances are pH 7.

-Acidity in soil: plants grow at a pH near 7. If it is too acidic or alkaline they will not grow. Acidic soil is fixed by adding lime.

Strong acids: all molecules **dissociate** to become ions, low pH, high conductivity, weak bonds

Weak acids: only some molecules do, higher pH, low conductivity, strong bonds (weaker effervescence when reacting with carbonates or metal than a strong acid, this property can be used in experimental demonstrations)

Strong alkali: high conductivity and pH, weak bonds, high dissociation

Weak alkali: low conductivity and pH, strong bonds therefore low dissociation

In alkalis, more dissociation i.e. higher concentration of OH⁻ ion = higher pH.

In acids, higher concentration of H⁺ ion (proton) = lower pH

Universal indicator is an indicator which can be used as paper or in solution



8.2 Types of oxides

(NOTE: this was the first question on the paper 3 in the mock exam)

In general, metal oxides are **basic**, and non-metal oxides are **acidic**.

Neutral oxides: are neither acidic nor basic, they are neutral for example carbon monoxide.

Amphoteric oxides: e.g. Aluminium oxide and zinc oxide: they react with bases and acids.

8.3 Preparation of salts

Preparing salts in the lab (all on pages 124 and 125)

Starting with a metal:

1. Add excess metal to an acid
2. When bubbling (hydrogen) stops the reaction is done
3. Filter off excess metal (because a metal is a solid, except mercury)

Starting with an insoluble base:

1. Add insoluble base to acid and heat gently, it will dissolve
2. Keep adding until no more dissolves (reaction is done)
3. Filter out the insoluble (excess) base

(Titration): Starting with an **alkali (soluble base)**:

1. Put a certain amount (e.g. 25cm³) alkali in a flask
2. Add phenolphthalein (pink in alkaline, colourless in acid or neutral) you could use a different indicator but this is quite simple
3. Add acid from a burette, slowly while stirring, until it goes colourless
4. Find out how much acid you used (using the scale on the burette).
5. Repeat, this time add the same amount of base, but you know exactly how much acid to add to get a neutral solution, don't add indicator though (you don't need it anymore, and it would make it impure)
6. Evaporate the water from the neutral solution using a Bunsen flame and an evaporating dish

If they don't tell you if the salt is soluble or not then you need to know this:

<u>Soluble salts are:</u>	<u>Insoluble salts are:</u>
all potassium, sodium and ammonium salts	
all nitrates	
Halides except	silver and lead halides
Sulphates except	Calcium, barium and lead sulphate

potassium, sodium and ammonium carbonates	All other carbonates
---	----------------------

8.4 Identification of ions and gases

Aqueous cations:

Test	Ion	Result
Add a few drops of dilute sodium hydroxide solution. A precipitate will form.	Cu^{2+}	Pale blue precipitate
	Fe^{2+}	Green precipitate
	Fe^{3+}	Red-Brown precipitate
	Al^{3+} , Zn^{2+} , Ca^{2+}	White precipitate
Divide the solutions into two equal volumes. To one, add double the volume of sodium hydroxide solution. To the other, add double the volume of aqueous ammonia.	Al^{3+}	The precipitate dissolves again in sodium hydroxide solution giving a colourless solution but not in excess ammonia solution
	Zn^{2+}	Precipitate dissolves in both solutions, giving a colourless solution.
	Ca^{2+}	Dissolves in neither.
Take a small amount of the solid or solution. Add a little dilute sodium hydroxide solution and heat gently.	NH_4^+	Ammonia gas given off (it has a strong sharp smell and turns red litmus blue)

Anions:

Test	Ion	Result
Take a small amount of the solid/solution. Add a little dilute hydrochloric acid.	Carbonate	Carbon dioxide gas is produced so there are bubbles and limewater goes milky
Take a small amount of the solution. Add an equal volume of dilute nitric acid. Then add silver nitrate solution. Silver halides are insoluble, so a precipitate forms.	Chloride	White precipitate
	Iodide	Yellow
Take a small amount of the solution. Add a little sodium hydroxide solution. Add aluminium foil and heat gently.	Nitrate	Ammonia gas given off
Take a small amount of the solution. Add an equal volume of dilute hydrochloric acid. Then add barium nitrate solution. Barium sulphate is insoluble so...	Sulphate	White precipitate (barium sulphate)

Gases:

Test	Gas	Result
Smell gas, use indicator paper.	Ammonia	Recognizable odour, indicator paper turns blue
It is a weak acid, so reacts with calcium hydroxide (lime water) to form insoluble calcium carbonate	Carbon Dioxide	white precipitate, solution goes milky

Green poisonous gas which bleaches dyes. Hold damp indicator paper in the gas (in a fume cupboard).	Chlorine	Indicator paper turns white.
Collect in a tube then put a lighted splint to it.	Hydrogen	Squeaky pop
Collect in a tube then put a glowing splint to it.	Oxygen	Splint immediately bursts into a flame

9. Periodic Table

The **Periodic table** is a method of classifying elements. They are arranged in order of increasing atomic number. The columns are called **groups**. The rows are called **periods**. Metals are to the left and non-metals are to the right. Elements in the same group have similar properties. For a specific group, group number tells us the number of valency electrons and the period number tells us about the number of electron shells. Depending on whether an element is a metal or a non-metal, this information can help us to predict the properties.

9.1 Periodic trends

Non-metals are on the right side of the periodic table, and metals are on the left. If you go down a period of metals (but not the transition metals) they become more reactive (this is because there are more electron shells so since metals lose electrons the more electron shells they have, the weaker the bond is between the positive nucleus and the valency electrons, so the more easily it is lost.) With non-metals, going down a period, the non-metal becomes less reactive (the reason is the opposite than for metals).

9.2 Group properties

Alkali metals (only lithium, sodium and potassium for IGCSE):

Physical properties:

- Good conductors of heat and electricity.
- Are soft, compared to other metals.
- They have low densities (for metals).
- They have low melting and boiling points compared to most metals.

Chemical properties:

- Form ionic compounds
- React violently with chlorine
- Burst into flames when heated with oxygen:
 - a red flame for lithium
 - a yellow flame for sodium
 - a lilac flame for potassium
- Produce soluble white compounds.
- React with cold water.

Patterns: Reactivity, density and softness increases further down the group i.e. Caesium is more reactive than lithium. Melting and boiling points decrease. Reactivity increases because more electron shells means there is a less strong attraction between the nucleus and the valency electron so it is lost more easily.

Halogens, group 7 – physical properties:

- form coloured gases (at room temperature, fluorine is a yellow gas, chlorine is a green gas, bromine is a red liquid, and iodine is a black solid)
- are poisonous
- are brittle and crumbly in solid form
- do not conduct electricity
- form diatomic molecules

Patterns: (down the group) size, mass and density increase (and colour darkness). Reactivity decreases, because it has to gain an electron, so the closer the electron is to the positive nucleus the more easily it will be gained, so atoms with fewer shells will react more easily.

9.3 Transition elements

A collection of metals with the following properties:

- hard, tough and strong
- high melting points (except mercury)
- malleable (can be hammered into different shapes) and ductile (can be drawn out into wires)
- good conductors of heat and electricity (silver is the best)
- high density (greater than water's density)
- Much less reactive than group one metals, except for iron which rusts easily
- Have no trend in reactivity
- can be used as catalysts
- Mostly form coloured compounds
- can form complex ions
- Can form several differently charged ions: have variable valency, therefore.....
- they can form more than one compound with another element: FeO, Fe₂O₃

9.4 Noble gases

Noble gases are unreactive, (also non metals, colourless gases and monatomic).

Uses:

Helium- filling balloons and aircrafts because it is lighter than air and will not catch fire.

Argon – filling (tungsten) light bulbs to stop the filament reacting with oxygen (inert)

Neon – is used in advertising signs because it glows red.

10. Metals

10.1 Properties of metals

(Usual) Physical properties:

- High melting points (except mercury)
- Malleable and ductile
- Good conductors of heat – because of their free electrons
- Good conductors of electricity – because of their free electrons
- Have high densities
- They are sonorous
- Sometimes magnetic (e.g. iron)

(Usual) Chemical properties:

- Form positive ions
- React with oxygen to form oxides

Metals are often used as **alloys** (mixtures of metals with other metals and/or non metals) because they have an increased range of uses, the mixture of atoms gives an irregular structure which stops the layers sliding over each other so easily, so they are stronger.

This is what the structure of an alloy (a) looks like, compared to a pure metal (b).

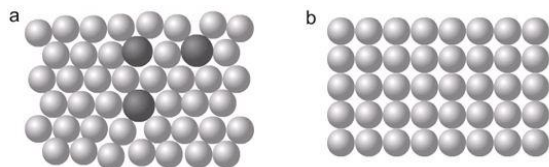

10.2 Reactivity series

K - Potassium

Na - Sodium

Ca – Calcium

Mg – Magnesium

Al – Aluminium

C – Carbon

Zn – Zinc

Fe – Iron

Pb – Lead

H – Hydrogen

Cu – Copper

Ag – Silver

Au – Gold

Everything above Hydrogen can displace hydrogen from its acid, and hydrogen cannot reduce their oxides. Metals above carbon, their oxides cannot be reduced by carbon. An element can displace another element from its oxide if it is more reactive e.g. copper oxide + zinc → copper + zinc oxide. More reactive metals will react with cold water, and less reactive will react slowly or not react with steam.

(Paper 6: copper (II) oxide is a **black** solid)

The elements further up the reactivity series form more stable compounds and have a greater desire to exist in a compound than as an element, so:

-metals will **displace** a less reactive metal from its oxide or...

-**displace** a less reactive metal from a salt in a solution.

Thermal decomposition:

Metal hydroxide → (heat) → metal oxide + water

This does not apply to potassium and sodium. It happens faster, the further you go down the reactivity series.

All nitrates decompose on heating, but don't all form the same products.

Potassium or sodium nitrate → (heat) → potassium or sodium nitrite + oxygen

Metal nitrate (except K and Na) → (heat) → metal oxide + nitrogen dioxide + oxygen

Aluminium seems unreactive because it naturally forms an oxide layer which protects it.

10.3 (a) Extraction of metals

-The most unreactive metals like copper and gold exist in their ores as elements. All that needs to be done is remove sand or soil and other impurities. They can be washed off, and no chemical reaction is needed.

-More reactive metals exist in compounds and have to be reduced, for example how iron oxide is reduced in the blast furnace by carbon monoxide to form iron. Carbon monoxide is a reducing agent.

-The more reactive metals have very stable compounds and must be extracted by electrolysis.

Aluminium's main ore is bauxite, it is purified to get alumina; it is Aluminium (III) oxide

[\(extraction of aluminium\).](#)

Extraction of iron from haematite in the blast furnace:

- 1) Coke burns with air: carbon + oxygen → carbon dioxide (exothermic)
- 2) Carbon dioxide reacts with coke: carbon dioxide + carbon → carbon monoxide (endothermic)
- 3) Iron (III) oxide + carbon monoxide → iron + carbon dioxide
- 4) Limestone reacts with impurities: calcium carbonate (limestone) + silicon dioxide (silica) → calcium silicate + carbon dioxide

Iron to steel: Molten iron from the blast furnace is poured into an **oxygen furnace**. Basic calcium oxide is added, and a jet of oxygen is turned on. The calcium oxide neutralises the acidic impurities, forming slag that is skimmed off. The oxygen burns the other impurities away. The carbon content is checked continually until it is just right –if there is too much it is brittle, too little and it is weak – then the oxygen is turned off.

Extraction of zinc from zinc blende: Zinc blende is zinc sulphide (ZnS). It is roasted in air, giving zinc oxide and sulphur dioxide.

Then either:

- 1) Zinc oxide is reduced by carbon monoxide in the furnace. Then the mixture of zinc and slag undergoes fractional distillation.

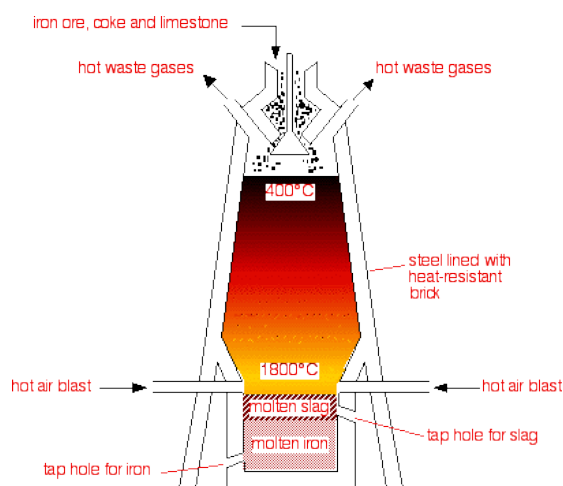

2) Zinc oxide is insoluble in water and has a melting point just under 2000°C. So it is dissolved in sulphuric acid. This is a neutralisation reaction: zinc sulphate solution is produced. In electrolysis, zinc is deposited at the cathode, then scraped off and melted into bars.

10.3 (b) Uses of metals

Aluminium is used for:

- in the manufacture of aircraft because of its strength and low density (as an alloy)
- in food containers because of its resistance to corrosion

Iron is made into steel alloys by the controlled use of additives (other elements) to improve its properties for example to make it stronger.

Mild steel (96% iron and 4% carbon) is used for car bodies and machinery and **stainless steel** (70% iron, 20% chromium and 10% nickel) is used in chemical plants and cutlery.

Zinc is used for **galvanising** and for making **brass** (70% and 30% copper).

Copper is non-toxic and a good conductor of heat and electricity so it is used in electrical wiring and cooking utensils.

11. Air and Water

Water

Chemical tests:

- 1) It turns white anhydrous copper (II) sulphate blue.
- 2) It turns blue cobalt chloride paper pink.

Purification of water:

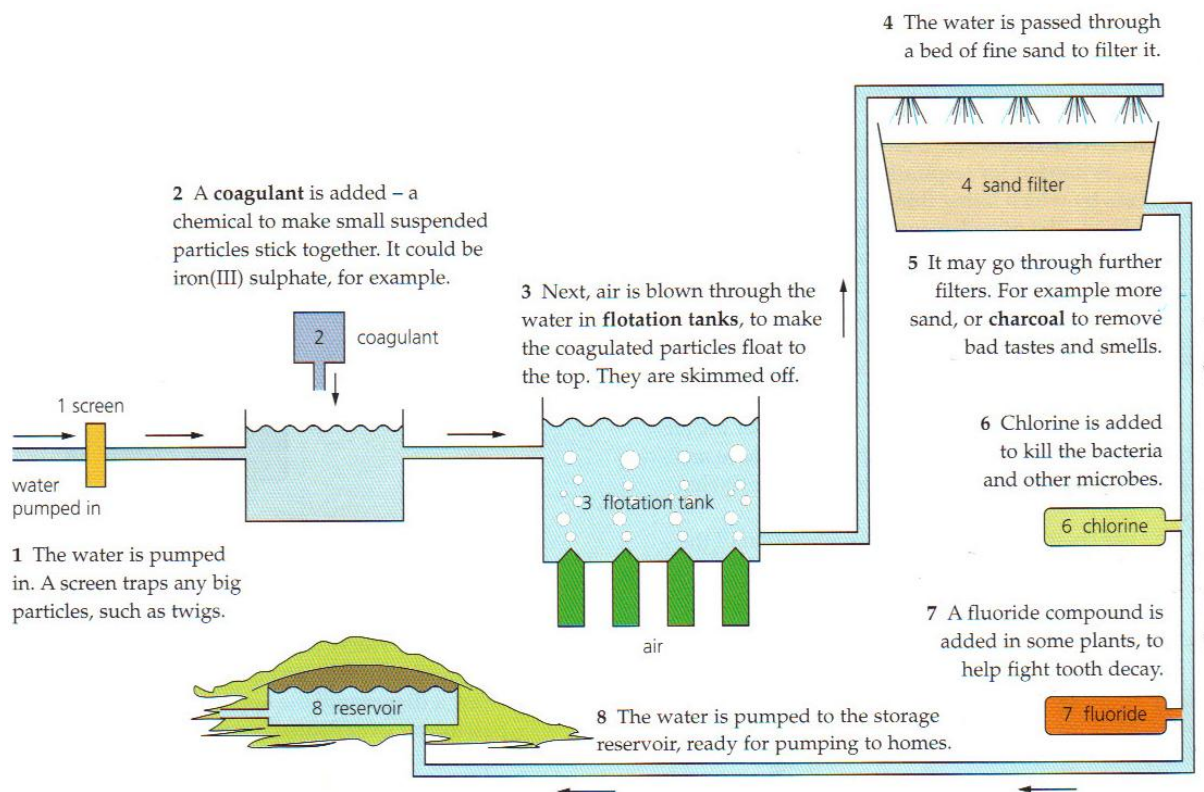

Uses: at home - drinking, cooking, washing (people, clothes, and dishes), in the toilet, on farms for animals or to water crops, in industry to dissolve, wash and cool things, and in power stations where steam is used to turn turbines.

Air

Clean air is approximately 79% nitrogen, 20% oxygen and the remainder is a mixture of noble gases, water vapour and carbon dioxide.

Common pollutants: carbon monoxide (from incomplete combustion of carbon-containing substances), sulphur dioxide (from combustion of fossil fuels containing sulphur compounds), nitrogen oxides (from hot furnaces and engines) and lead compounds (a lead compound is added to petrol to help it burn more smoothly).

Effects of pollutants: carbon monoxide – reacts with haemoglobin, preventing it from carrying oxygen – so you can die from oxygen starvation

Sulphur dioxide – irritates eyes and throat, causes respiratory problems and causes acid rain

Nitrogen oxides – causes respiratory problems, forms acid rain.

Extraction of nitrogen and oxygen: fractional distillation of liquid air:

1) Air is filtered to remove dust

2) Water vapour and carbon dioxide removed, (because they would freeze and block the pipes):

-air is cooled until water vapour condenses

-then passes over absorbent beads to trap carbon dioxide

3) It is compressed, causing it to heat up. Cooled by recycling cold air

4) The cold compressed air is passed through a jet, into a larger space. It expands rapidly, making it very cold.

Steps 3 and 4 are repeated, cooling the air more. By -200°C it is liquid except for neon and helium. These gases are removed. They can be separated from each other by absorption on charcoal.

5) The liquid air is pumped into the fractionating column. There it is slowly warmed up. The gases boil off one by one, and are collected in tanks or cylinders.

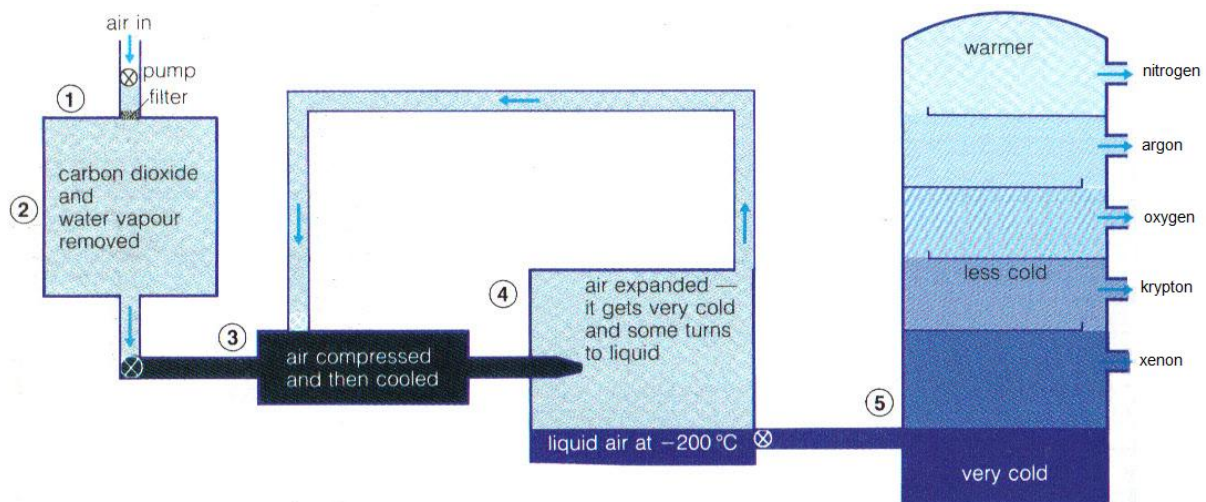

Nitrogen oxides are produced when oxygen and nitrogen from air react in hot conditions (in engines and furnaces). They are removed using a **catalytic converter**. Nitrogen oxides are decomposed back into nitrogen and oxygen.

Rust prevention: 1) coating with something to prevent contact with air and moisture (plastic, paint, grease, tin or chromium plating by electrolysis or galvanising (dipping in molten zinc)

2) Sacrificial protection

3) Anodising

Fertilisers: Nitrogen is needed for chlorophyll and other proteins. Potassium helps make proteins and resist diseases.

Phosphorus helps roots grow and crops ripen.

All alkalis (except ammonia) will react with ammonium compounds, removing ammonia for example: calcium hydroxide + ammonium chloride \rightarrow calcium chloride + water + ammonia.

Greenhouse gases: carbon dioxide and methane. They stop heat escaping in to space. Too much greenhouse gases leads to climate change. This will cause the ice poles to melt, rising sea levels, more droughts, storms, floods and famine.

Formation of carbon dioxide:

1) Product of respiration

2) COMPLETE combustion of carbon-containing substances

3) Reaction of an acid and a carbonate.

Sources of methane: oil and natural gas, decomposition of vegetation, and waste gases from digestion in animals.

Sacrificial protection: a more reactive metal is used to coat a less reactive metal. The more reactive metal will react more easily and be sacrificed.

The Haber process: $\text{N}_2 (\text{g}) + 3\text{H}_2 (\text{g}) \rightleftharpoons 2\text{NH}_3 (\text{g})$

Nitrogen comes from the air. Hydrogen can be made in several ways:

1) Methane + steam \rightarrow carbon dioxide + hydrogen

2) it can be cracked (using a catalyst): $C_2H_6 \rightarrow C_2H_4 + H_2$

CONDITIONS: 450°C, 200atm, iron catalyst

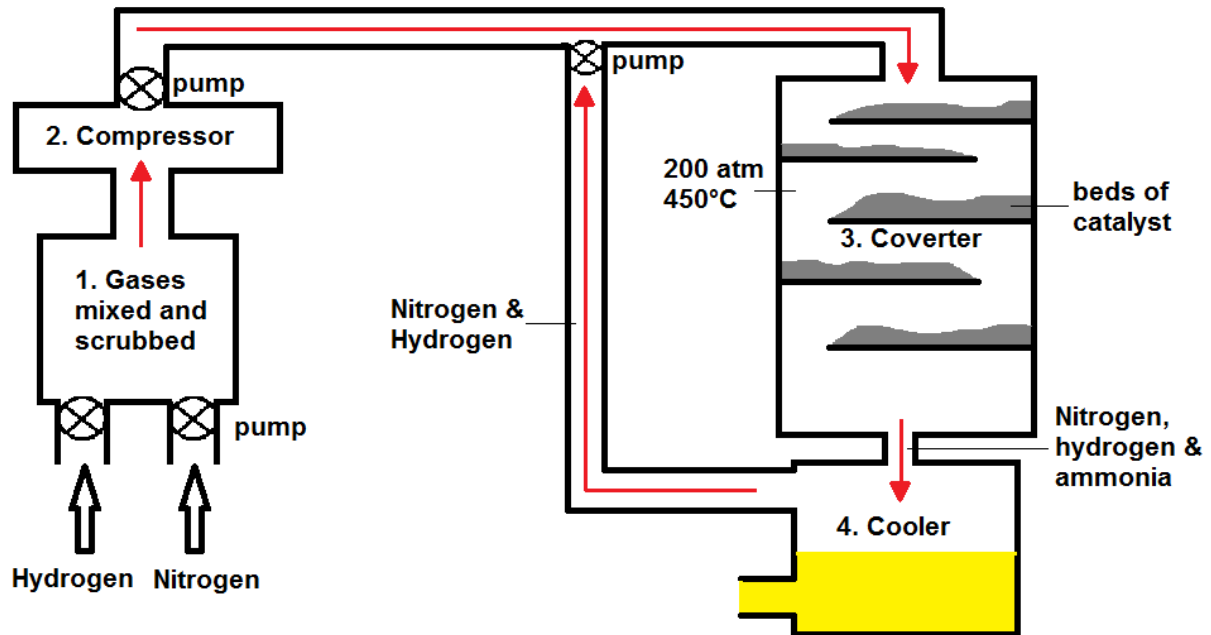

The forward reaction is exothermic, and the backwards reaction is endothermic.

The optimum conditions would be high pressure, low temperature, removing ammonia as it forms. Higher temperature is used for a better rate and lower pressure for safety and it is cheaper. A catalyst is used for a faster rate.

The carbon cycle:

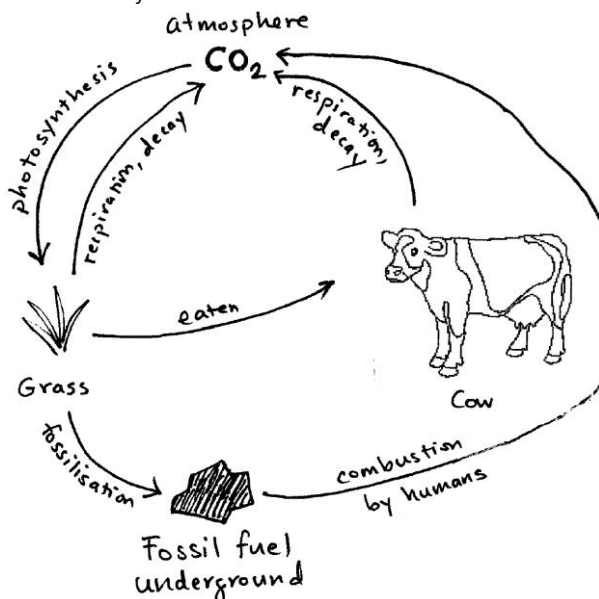

12. Sulphur

Sources: It is found as an element, in large underground beds in several countries. It is also found around the rims of volcanoes. It occurs in metal ores (lead sulphide aka **galena**). Sulphur compounds also occur naturally in the fossil fuels: coal, oil and natural gas.

Uses of sulphur: the manufacture of sulphuric acid (through the Contact process), vulcanising rubber, used to make drugs, pesticides, matches and paper, and some is added to cement to make sulphur concrete, which cannot be attacked by acid in walls and floors in factories.

Uses of Sulphur dioxide

- manufacture of sulphuric acid
- to bleach wool, silk and wood pulp for making paper

-it is used as a sterilising agent in making soft drinks and jam, and in drying fruit. It stops growth of bacteria and moulds.

Uses of sulphuric acid: making fertilisers such as ammonium sulphate, paints, pigments, and dyestuffs, fibres and plastics, soaps and detergent, acid in car batteries

The Contact process: sulphur → burned in air → sulphur dioxide → mixed with more air → passed over four separate beds of catalyst (pellets of Vanadium (V) oxide) at 450°C → sulphur trioxide → dissolved in concentrated sulphuric acid → thick fuming liquid called **oleum** → mixed carefully with water → concentrated sulphuric acid.

CONDITIONS: vanadium (V) oxide catalyst, 450°C, less than 2atm of pressure

Properties of sulphuric acid:

- Forms salts called sulphates
- When concentrated, it is a dehydrating agent, and a thick oily liquid
- It turns blue litmus red
- It is a strong acid
- normal strong acid properties (reacts with bases, low pH, high conductivity etc.)

13. Carbonates

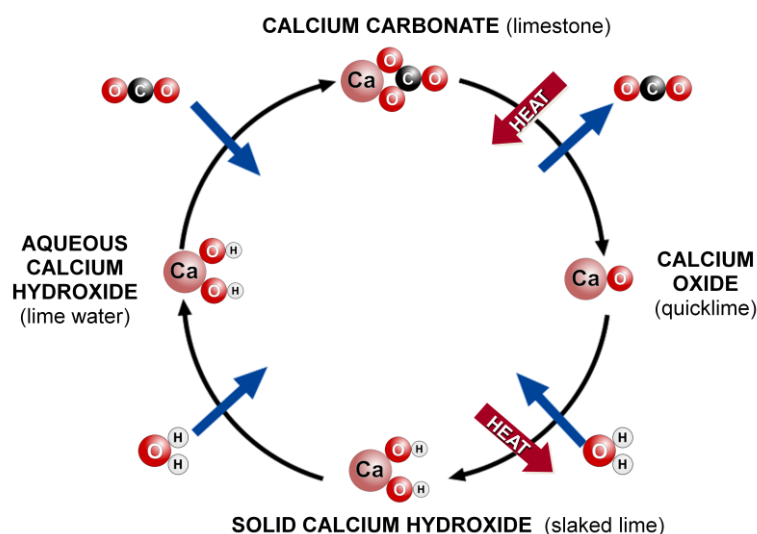

Manufacture of lime (CaO) from limestone (CaCO₃)

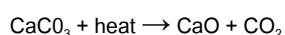

Uses of quicklime (CaO): making steel from iron, to neutralise acidity in soil, a drying agent in industry

Uses of slaked lime (calcium hydroxide): neutralise acidity in soil, and in lakes affected by acid rain, neutralising acidic industrial waste products, e.g. flue gas desulphurisation, made by adding CaO to water.

Uses of calcium carbonate (limestone): making cement – made by mixing limestone with clay, heating the mixture strongly in a kiln like the one below, adding gypsum (calcium sulphate), and grinding up the final solid to give a powder (diagram page 235).

Making iron from iron ore – the limestone reacts with (neutralises) sand (an impurity) forming slag (calcium silicate), which is then used for road building.

14. Organic chemistry

This is what is on the syllabus only, but I have made more concise notes which cover all of organic chemistry in the book chapters 17 and 18

BASICS (stuff that isn't in the syllabus but is important):

Alkane – general formula C_nH_{2n+2}

Alkene - functional group: C=C bond, general formula: C_nH_{2n}

Alcohol - the OH functional group and have the general formula: C_nH_{2n+1}OH

Carboxylic acid - COOH functional group, and have the general formula: C_nH_{2n+1}COOH

Addition polymerisation – all atoms in the monomer are used to form the polymer, double bonds in molecules break in order to form a new bond

Condensation polymerisation – 2 different monomers join, double bonds are not broken, in order for the monomers to join a small molecule has to be expelled like water or HCl

Esters are produced when carboxylic acids react with alcohols, the functional group is the ester link (a carbon with a double bond to an oxygen and a single bond to another oxygen, I don't think there is a general formula but if there was it would be something like this: $C_nH_{2n+1}COOC_tH_{2t+1}$ (note I used "t" and "n" since you can have several different combinations with one alcohol or one carboxylic acid

14.1 Names of compounds

Name and draw the structure of the following compounds:

Name	Chemical formula	Structure
methane	CH_4	<pre> H H — C — H H </pre>
ethane	C_2H_6	<pre> H H H — C — C — H H H </pre>
ethene	C_2H_4	<pre> H H \ / C = C / \ H H </pre>
ethanol	C_2H_5OH	<pre> H H H — C — C — O — H H H </pre>
ethanoic acid	CH_3COOH	<pre> H O // H — C — C \ H O — H </pre>

Name ending → compound-type name

"ane" → alkane

"ene" → alkene

"ol" → alcohol

"oic acid" → carboxylic acid

"yl", "oate" → ester (as in ethyl ethanoate)

Be able to draw the following

Name of family	Number of carbons			
	1	2	3	4
Alkane:	methane	ethane	propane	butane

Structure:				
Alkene: Structure:	NA	ethene 	propene 	but-1-ene
Alcohol: Structure:	methanol 	ethanol 	propanol 	butanol
Carboxylic acid: Structure:	methanoic acid 	ethanoic acid 	propanoic acid 	butanoic acid

14.2 Fuels

Fuels to know:

-coal

-natural gas (main constituent is methane)

-petroleum (a mixture of hydrocarbons which can be separated into fractions):

1. refinery gas – bottled gas for heating and cooking
2. gasoline fraction – fuel (petrol) in cars
3. naphtha fraction – making chemicals
4. kerosene/paraffin fraction – jet fuel, lamps
5. diesel oil/gas oil fraction – fuel in diesel engines
6. fuel oil fraction – fuel in ships and home heating systems
7. lubricating fraction – lubricants, waxes and polishes
8. bitumen – making roads

14.3 Homologous series

Homologous series: 'family' of similar compounds with similar properties due to the presence of the same functional group.

Characteristics of a homologous series:

-all the compounds fit the same general formula

-the chain length increases by 1 each time

-as the chain gets longer, the compounds show a gradual change in properties.

Structural isomers: have the same chemical formula, but different structures, they can be **straight** or **branched**.

14.4 Alkanes

Each carbon atoms in an **alkene** has four covalent single bonds – this makes them quite unreactive.

They only have two reactions:

-**combustion** this can either be:

-**complete:** meaning there is enough oxygen supply so water and carbon dioxide form.

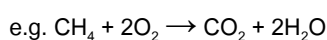

OR

-**incomplete:** meaning there is not enough oxygen to burn them cleanly so either carbon monoxide and water or carbon and water form.



-chlorine substitution: sunlight is necessary (or any light?). A chlorine atom replaces a hydrogen atom. This can happen to all of the hydrogen atoms if there is enough chlorine.

e.g. $\text{CH}_4 + \text{Cl}_2 \xrightarrow{\text{light}} \text{HCl} + \text{CH}_3\text{Cl} / \text{CH}_2\text{Cl}_2 / \text{CHCl}_3 / \text{CCl}_4$ these compounds are called chloromethane / dichloromethane / trichloromethane / tetrachloromethane

14.5 Alkenes

Cracking: is a **thermal decomposition** reaction, in which an alkane (and sometimes hydrogen) are produced from an alkane. Cracking always produces a short chain compound with a C=C bond. Cracking of ethane will give ethene and hydrogen.

In the lab it looks like this:

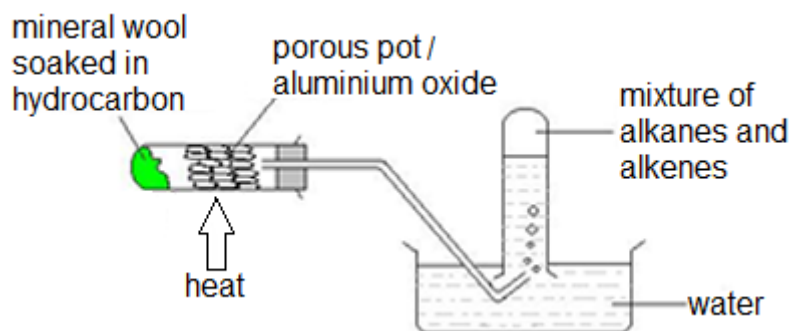

Saturated hydrocarbons:

- have NO double bonds
- do not react with aqueous bromine, so the mixture stays orange.

Unsaturated hydrocarbons:

- have double bonds
- react with aqueous bromine, turning the mixture from orange to colourless.

Poly(ethene) / Polythene: is a **polymer** produced from ethene by **addition polymerisation**. A polymer is a compound with very long carbon chains made up of **monomer units**.

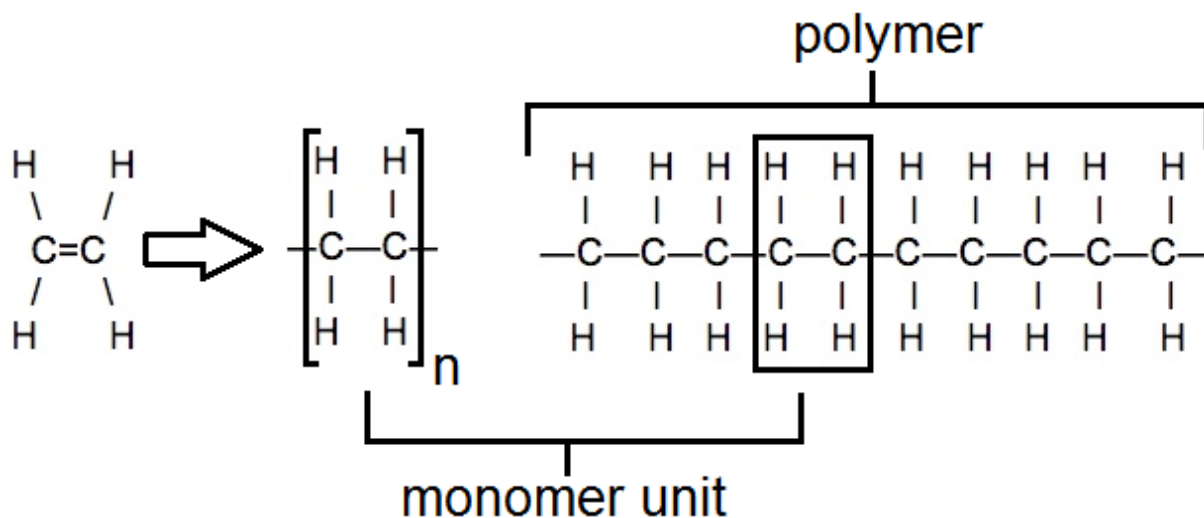

Alkenes' Addition Reactions:

-with **bromine:** (the test for saturation)

e.g. ethene (g) + bromine (aq) \rightarrow 1,2-dibromomethane (l)

-with **steam:** forms **alcohols** with heat, pressure and a catalyst

e.g. ethene (g) + steam (g) \rightleftharpoons ethanol (l)

-with **hydrogen:** double bond breaks down to form an alkane with heat, pressure and a catalyst

e.g. ethene (g) + hydrogen (g) \rightarrow ethane (g)

14.6 Alcohols

Ethanol can be formed in two ways:

1) By fermentation: enzymes in yeast break down glucose (a simple sugar) to ethanol and carbon dioxide, giving out heat (exothermic). This can be done with any substance that contains cellulose, starch or glucose. It is done by grinding the source (e.g. corn or grapes) and treating it with enzymes to break down cellulose and starch into glucose. Leave it to ferment. Fractional distillation is used to get the ethanol from the mixture of substances.

2) Ethene is obtained by cracking long-chain alkenes from oil. The ethene reacts with steam (reversibly) in the following conditions: 570°C, 60-70atm and a catalyst (phosphoric acid). Low temperature gives a better yield, but high temperature is used to give a better rate of reaction.

*They can be compared like this (in the syllabus it says "describe" so I don't know how much they want you to know):

Fermentation	From ethene
<u>Advantages:</u> -renewable source -good use of waste organic material (e.g. the apples which don't look nice enough to be sold in shops.)	<u>Advantages:</u> -fast -continuous process -pure ethanol -smaller containers
<u>Disadvantages:</u> -Lots of material needed to produce just 1 litre of ethanol so lots of big fermentation tanks needed. -Fractional distillation is expensive -Slow process -Batch process	<u>Disadvantages:</u> -oil is a non-renewable resource -lots of energy to make steam and get the right conditions -a lot of ethene is un-reacted, (and then recycled)

Ethanol burns well in oxygen, giving out plenty of heat, as well as carbon dioxide and water.

Ethanol is used as a:

-solvent: to dissolve the things than water cannot. It evaporates easily, so it is used a solvent in glues, printing inks, perfumes and aftershave.

-fuel: added to or instead of petrol, because it burns cleanly

14.7 Acids

Formation of ethanoic acid:

-oxidation of ethanol

-with acidified potassium manganate (VII)

Ethanoic acid is a typical weak acid: it has a high (as in closer to 7 than 1) pH for an acid, and only dissociates a little bit.

Carboxylic acids react with alcohols to give esters, in a **condensation reaction**, for example:

Ethanoic acid + ethanol \rightleftharpoons ethyl ethanoate + water (the alcohol's name becomes "-yl" part and the carboxylic acid's name becomes the "-oate" part.

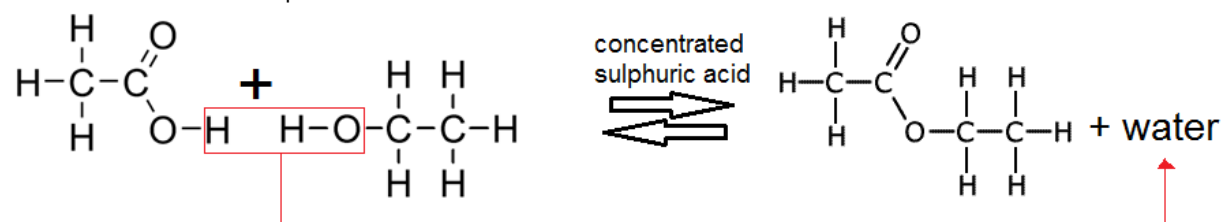

14.8 Macromolecules

Macromolecules are large molecules built up from small units (monomers). Different macromolecules have different units and/or different linkages (that's all you have to know!) For example glucose (the small unit) can join together to make starch or cellulose (natural macromolecules). (NOTE: diamonds are other examples of macromolecules).

Examples of the small units:

- glucose
- amino acids
- fatty acids and glycerol

Examples of linkages:

- amide
- ester

Examples of macromolecules:

- protein
- starch
- lipids

14.8 (a) Synthetic polymers

Uses of plastics:

Polymer	Example of uses
polythene	plastic bags and gloves, clingfilm (low density), mugs, bowls, chairs, dustbins (high density)
polychloroethane (PVC)	water pipes, wellingtons, hoses, covering for electricity cables
polypropene	crates, ropes
polystyrene	used as expanded polystyrene in fast-food cartons, packaging, and insulation for roofs and walls
Teflon	coated on frying pans to make them non-stick, fabric protector, windscreen wipers, flooring
nylon	ropes, fishing nets and lines, tents, curtains
Terylene	clothing (especially mixed with cotton), thread

Pollution problems from plastics:

-choke birds, fish and other animals that try to eat them. Or they fill up the animals' stomachs so that they can't eat proper food, and starve to death.

-they clog up drains and sewers and cause flooding.

-they collect in rivers, and get in the way of fish. Some river beds now contain a thick layer of plastic

-they blow into trees and onto beaches. So the place looks a mess. Tourists become put off.

Deduce the structure of the polymer product from a given alkene and vice versa (I just found as many as I could from the power points on moodle):

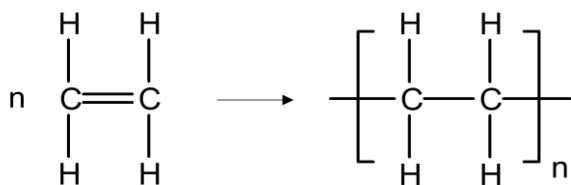

ethene

poly(ethene)

polythene

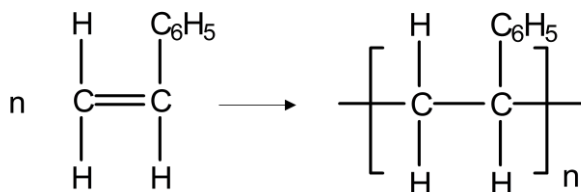

phenylethene

poly(phenylethene)

polystyrene

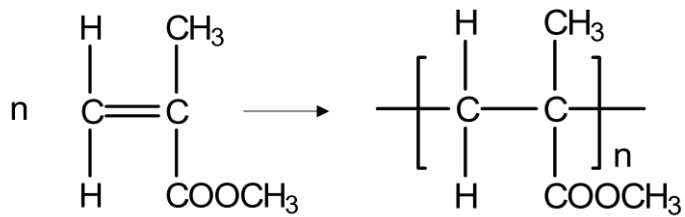

methyl 2-propenoate

poly(methyl 2-propenoate)

perspex

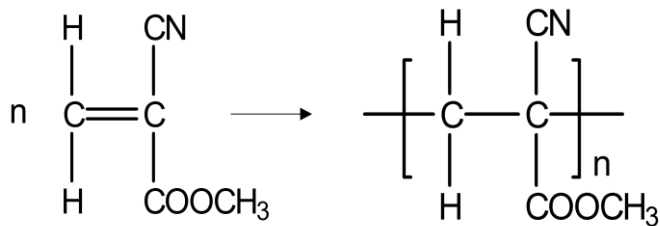

methyl 2-cyanopropenoate

poly(methyl 2-cyanopropenoate)

superglue

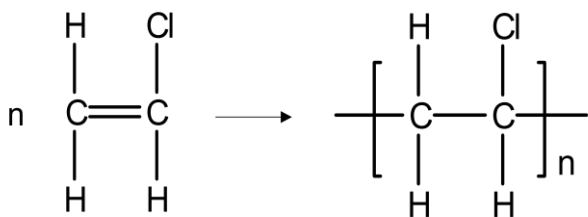

chloroethene

poly(chloroethene)

PVC

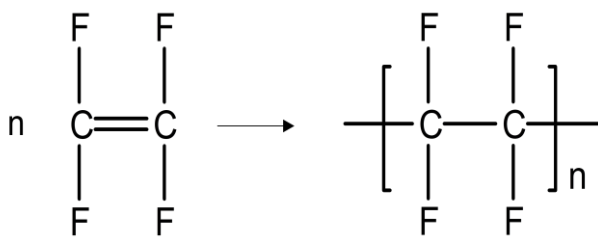

tetrafluoroethene

poly(tetrafluoroethene)

PTFE / Teflon

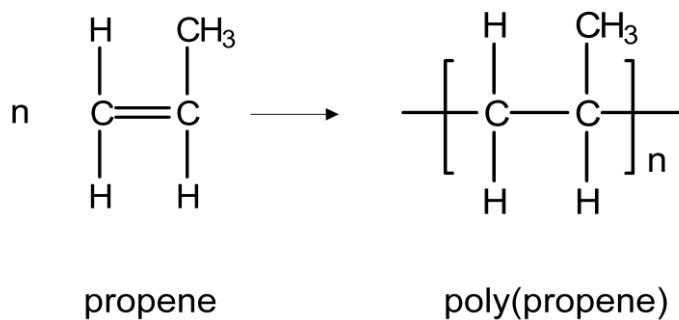

(For making nylon and Terylene: details of manufacture and mechanisms of these polymerisations are **not** required.)

Making nylon (a polyamide):

The monomers are:

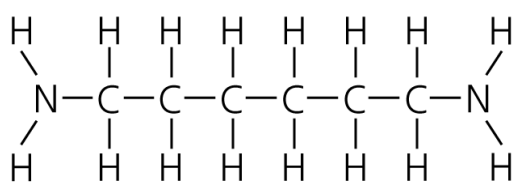

A 1,6-diaminohexane

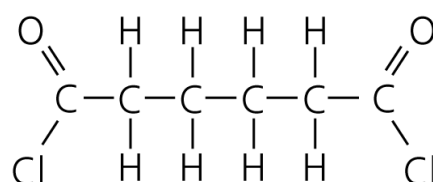

B hexan-1,6-dioyl chloride

But they are represented like this:

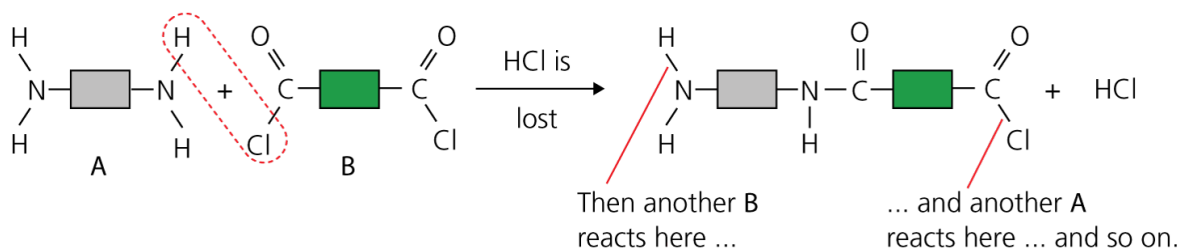

No double bonds break. Instead, single bonds break, and new single bonds form. The monomers are able to join to each other by eliminating a small molecule: hydrogen chloride. This reaction continues at each the two monomers. Thousands of molecules join together, giving a macromolecule:

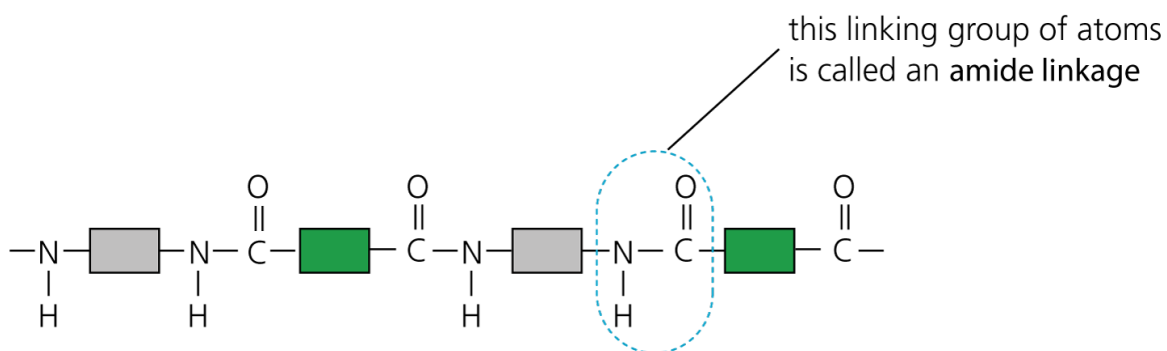

Making Terylene (a polyester):

The monomers are:

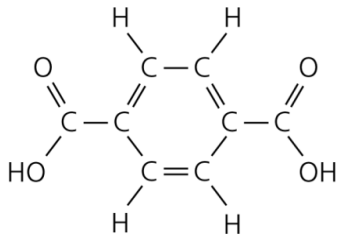

C benzene-1,4-dicarboxylic acid

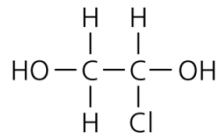

D ethane-1,2-diol

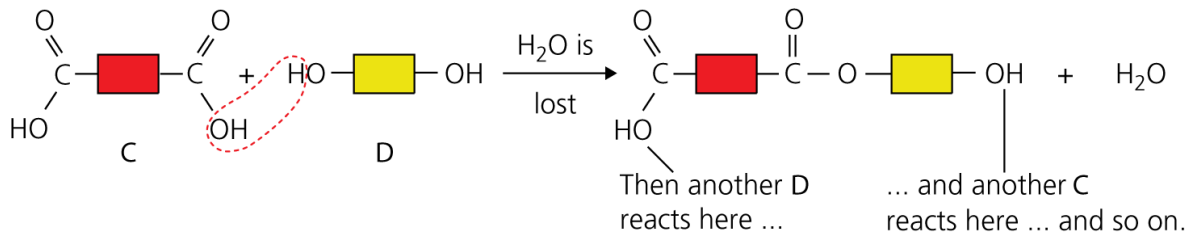

The monomers join by eliminating a water molecule. Thousands of molecules join up, giving a macromolecule.

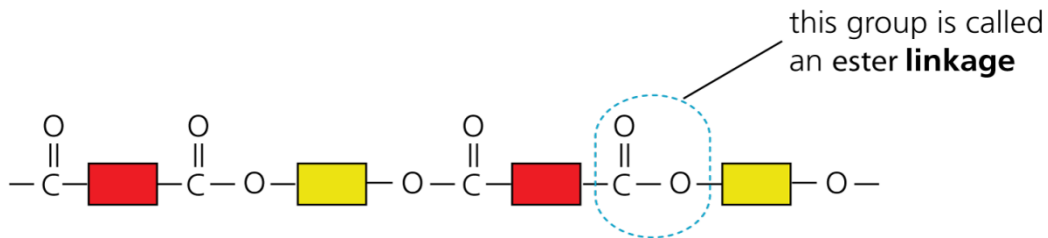

14.8 (b) Natural macromolecules

Food's main constituents are proteins, fats and carbohydrates.

Proteins contain the same linkages (amide links) as nylon, but with different units.

Similarly, lipids and terylene both have ester links but different units.

The structure of a protein is:

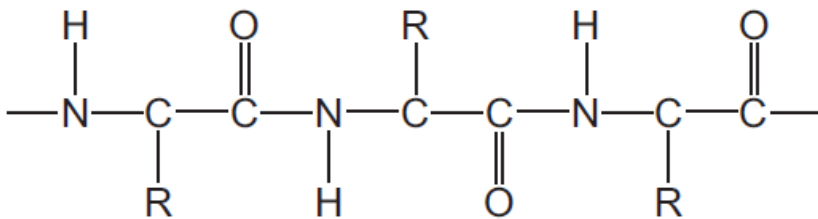

In digestion proteins are broken down into amino acids (**hydrolysis**).

Fats are esters possessing the same linkage as Terylene (ester links) but with different units.

Soap is a product of the hydrolysis of fat. It is done using sodium hydroxide (as opposed to acid, in digestion). The hydrolysis gives glycerol and the sodium salts of fatty acids. The salts are used as soaps.

Complex carbohydrates: are a large number of joined sugar units (**monosaccharide** like glucose). The sugar units are represented like this:



They join together in a **condensation polymerisation**:

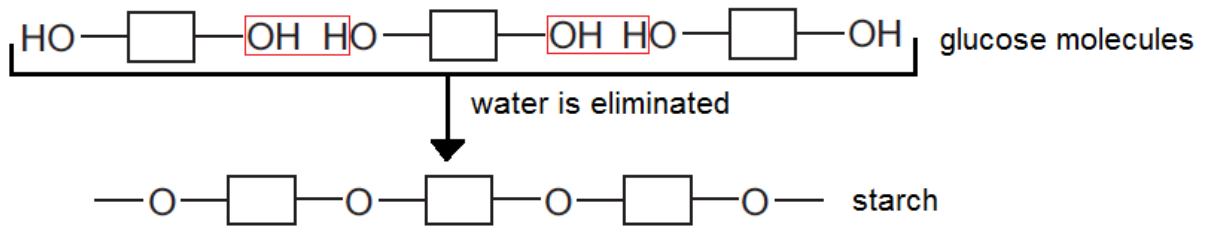

In digestion, the **hydrolysis** (Decomposition of a chemical compound by reaction with water, such as the dissociation of a dissolved salt or the catalytic conversion of starch to glucose, which can be accelerated by an acid or base) of starch happens in the mouth by the enzyme **amylase** to make glucose.

In the lab, unless you have enzymes, you have to boil the complex carbohydrate (or proteins or fats) in acid the products will be the following:

-starch → glucose

-proteins → amino acids

-fats → fatty acids and glycerol

But if hydrolysis is not complete, the macromolecules are not completely broken down. So you get a mixture of molecules of different sizes for example for starch you get, glucose, maltose (2 glucose units) and maltotriose (3 glucose units). Chromatography can be used to identify the products and the substances. However, amino acids and sugars are colourless when dissolved in water, so a locating agent is used. The substances can be identified using the R_f values or by matching them with spots which are horizontal.