

# Merchant Taylors School

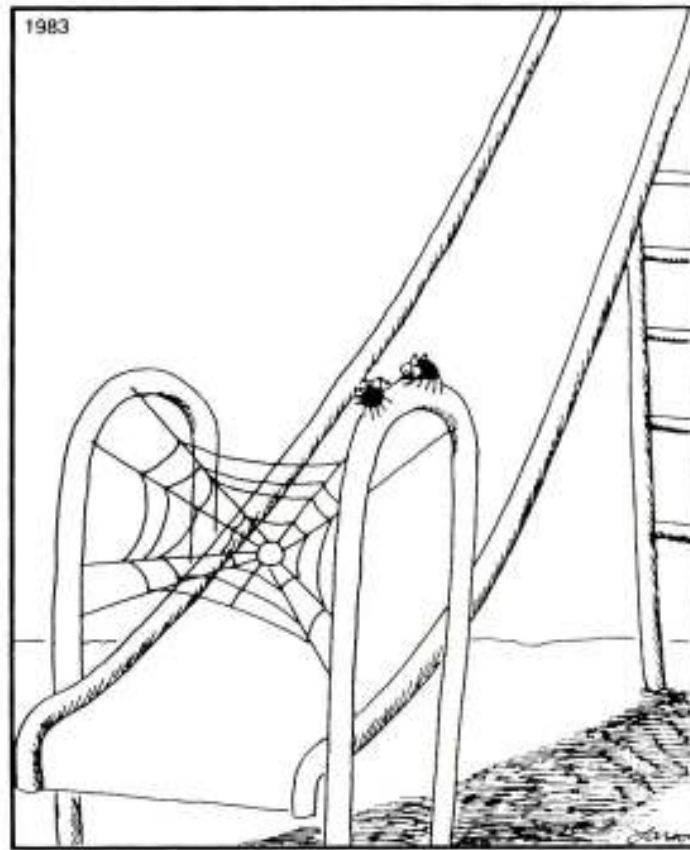

"If we pull this off, we'll eat like kings."

## Biology IGCSE Revision Workbook

**Tripple Award Specification**

**(4BIO) Examination in 2011**

# iGCSE REVISION NOTES

## Tripple Award Specification

Key words are underlined in red. Practical work is printed in *italics*.

### Section 1: The nature and variety of living organisms

Characteristics of living organisms include;

Movement

Respiration

Sensitivity

Growth

Reproduction

Excretion

Nutrition

In addition, all living organisms contain **nucleic acids** (DNA) and have the ability to **control their internal conditions**. Finally, all living organisms can **die**.

Living organisms are classified into 5 groups, each of which has certain characteristics you need to learn

#### Plants:

1. Multicellular organisms
2. Cells contain chloroplasts and are able to carry out photosynthesis
3. Cells have cellulose cell walls

4. They store carbohydrates as starch or sucrose.

**Examples** include flowering plants, such as a cereal (e.g. maize) and a herbaceous legume (e.g. peas or beans).

### Animals:

1. Multicellular organisms
2. Cells **do not** contain chloroplasts and are **not** able to carry out photosynthesis
3. Cells have **no** cell walls
4. They have a nervous system
5. They often store carbohydrate as **glycogen**

**Examples** include mammals (e.g. humans) and insects (e.g. housefly).

### Fungi:

1. They are **saprophytic** and feed by excreting digestive enzymes onto food and absorbing the digested products
2. Cells **do not** contain chloroplasts and are **not** able to carry out photosynthesis
3. Cells are joined together to form threads, called **hyphae**. Hyphae contain many nuclei, because they are made from many cells.
4. Cell walls are made from **chitin** (a protein)
5. They store carbohydrates as **glycogen**.

**Examples** include Mucor and Yeast (which is single celled).

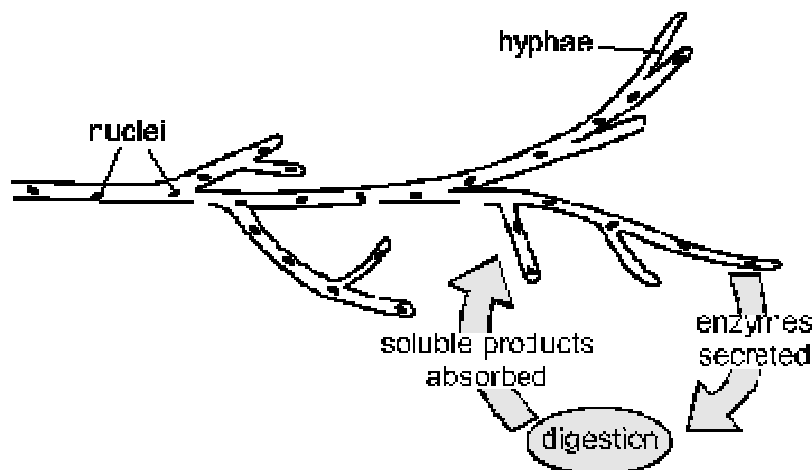

Bacteria:

1. Made from **single cells**
2. Cells **do not** contain a nucleus, but have a small piece of circular DNA instead (a **bacterial chromosome**).
3. Some bacteria can carry out rudimentary photosynthesis, but most are **saprophytes**
4. They have the structure below (learn it, it comes up!)

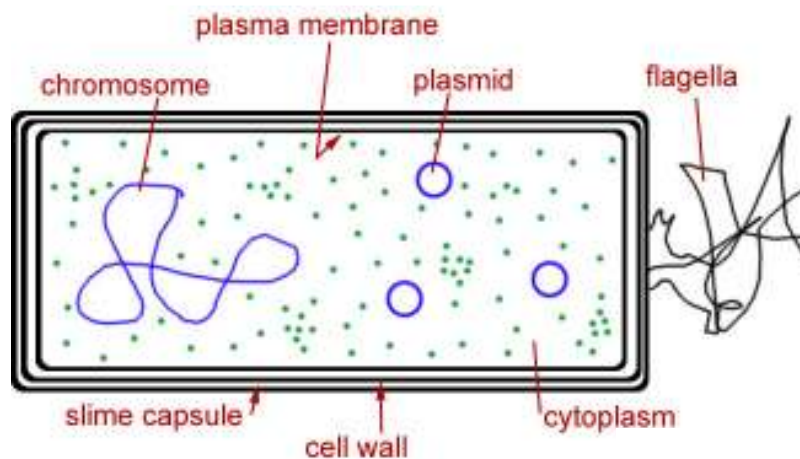

**Examples** include *Lactobacillus bulgaricus* (a rod-shaped bacterium used in the production of yoghurt from milk) and *Pneumococcus* (a spherical bacterium that causes Pneumonia)

Protoctists:

Basically, everything that doesn't fit into the other kingdoms! Most are single celled organisms which can either;

1. Have animal-like characteristics (e.g. *Amoeba*)
2. Have plant-like characteristics (e.g. *Chlorella*)

However, some protoctists are multicellular (e.g. seaweeds, yes they're NOT plants!)

Viruses:

1. Much smaller than bacteria. **They are not made from cells**
2. Totally **parasitic** and reproduce inside host cells.
3. They infect every type of living cell
4. They have the structure below (learn it, it comes up!)

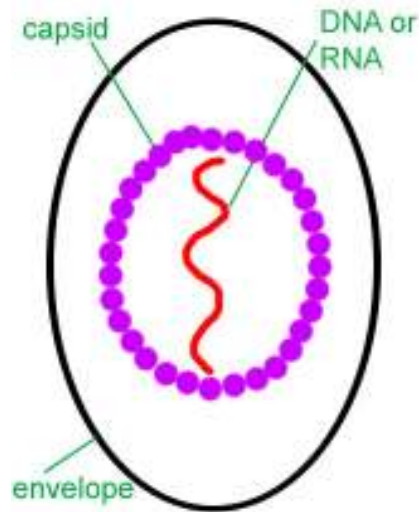

The **Envelope** is used to gain entry into host cells.

The **Capsid** is a protein coat and is used to protect the genetic information and give the virus structure

The DNA or RNA (a different type of **nucleic acid**) contain the code for building new viruses.

**Examples** include the Tobacco Mosaic Virus and the Influenza virus (which causes 'flu).

## Section 2: Structures and Functions in Living Organisms

### a) Levels of organization

Organisms are made from organizations of smaller structures. You need to know the following hierarchy of structures.

**Organelles** - intracellular structures that carry out specific functions within a cell

**Cells** - the basic structural and functional unit from which all biological organisms are made

**Tissues** - a group of specialized cells, which are adapted to carry out a specific function.

**Organs** - a collection of two or more tissues, which carries out a specific function or functions

**Organ Systems** - a group of two or more organs

## b) Cell structure

You need to know the differences between plant and animal cells, the functions of the organelles and be able to recognize them in a microscope picture or drawing.

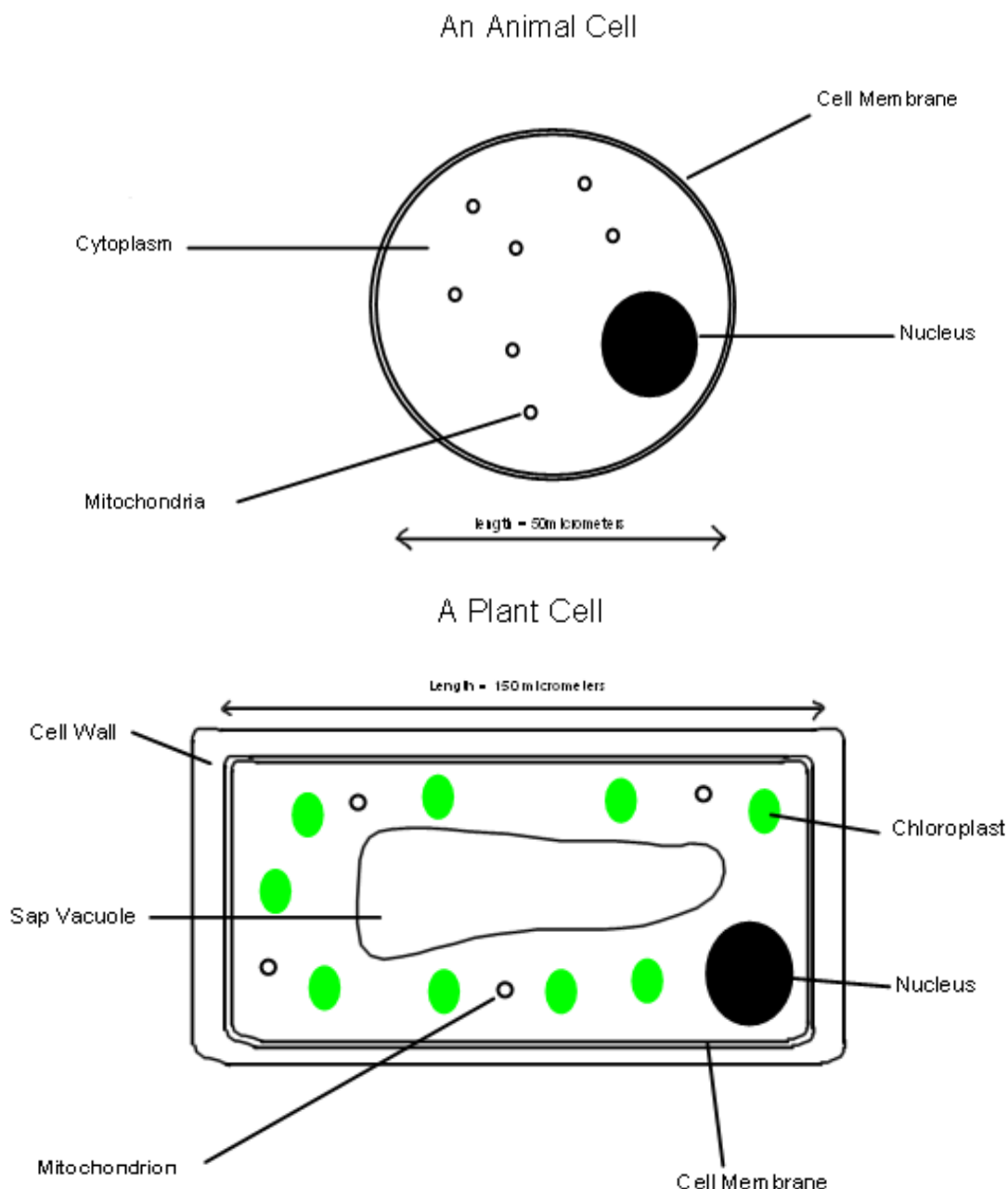

Differences between plant and animal cells:

Organelle	Animal Cell	Plant Cell
Chloroplast	X	√
Cell Wall	X	√
Sap Vacuole	X	√
Chlorophyll	X	Found in chloroplast
Size	Roughly 50µm long	Roughly 150µm long
Shape	No fixed shape	Rectangular

N.B. The cells are measured in µm (**micrometers**). One micrometer is 1/1000<sup>th</sup> of a millimetre.

Functions of the Organelles:

**Cytoplasm** - site of chemical reactions in the cell

**Cell Membrane** - controls what enters / leaves the cell (selectively permeable)

**Nucleus** - contains nucleic acids, which code for the synthesis of specific proteins. These proteins control all activity in the cell

**Mitochondrion** - site of respiration

**Chloroplast** - site of photosynthesis

**Cell Wall** - made from **cellulose**. Strengthens the cell and allows it to be **turgid**

**Sap Vacuole** - contains the cell sap. Acts as a store of water, or of sugars or, in some cases, of waste products the cell needs to excrete.

c) Biological molecules

Food Tests:

Lipids are tested for using the **Emulsion test**

Proteins are tested for using the **Biuret test**

Starch is tested for using **Iodine solution**

Glucose is tested for using **Benedict's test**

The Food Groups:

Food Group	Function
Lipids (fats & oils)	Used as a <b><u>long-term energy store</u></b> (much easier to store than carbohydrates). Also have a role in <b><u>protection</u></b> and <b><u>insulation</u></b>
Carbohydrates	Made from single sugars or chains of sugars. They are used in <b><u>respiration</u></b> to provide <b>energy</b> .
Proteins	Broken down into <b><u>amino acids</u></b> , which our body absorbs and assembles into new proteins. The proteins are used for <b>growth</b> and <b>repair</b> .
Fibre	Regulates bowel movement. Sloughs off old lining of intestine.
Water	Essential as a solvent for chemical reactions (e.g. cytoplasm), heat loss (e.g. transpiration), transport (e.g. blood) etc
Vitamins and Minerals	Essential for the normal function of some enzymes and proteins e.g. $\text{Fe}^{2+}$ is an essential part of <b><u>Haemoglobin</u></b> and $\text{Mg}^{2+}$ is part of <b><u>Chlorophyll</u></b>

Components of the main Food Groups:

The main food groups are carbohydrates, lipids and proteins. All three groups are made from smaller molecules.

Carbohydrates are large molecules made from one or more sugars (e.g. both **Starch** and **Glycogen** are both **polymers** of **Glucose**)

Proteins are polymers of **Amino Acids**

Lipids are made from one **glycerol** molecule and three **fatty acid** molecules joined together.



## Enzymes:

- Are proteins
- Are biological **catalysts** (speed up chemical reactions)
- Are specific to one particular **Substrate**
- Are affected by temperature and pH
- Are not used up in the reaction they catalyze

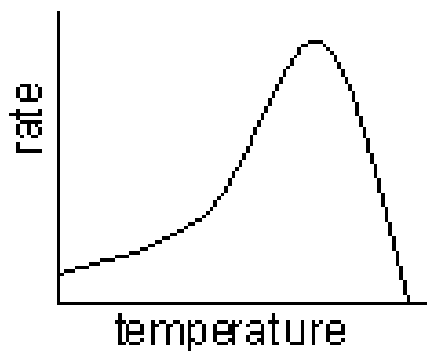
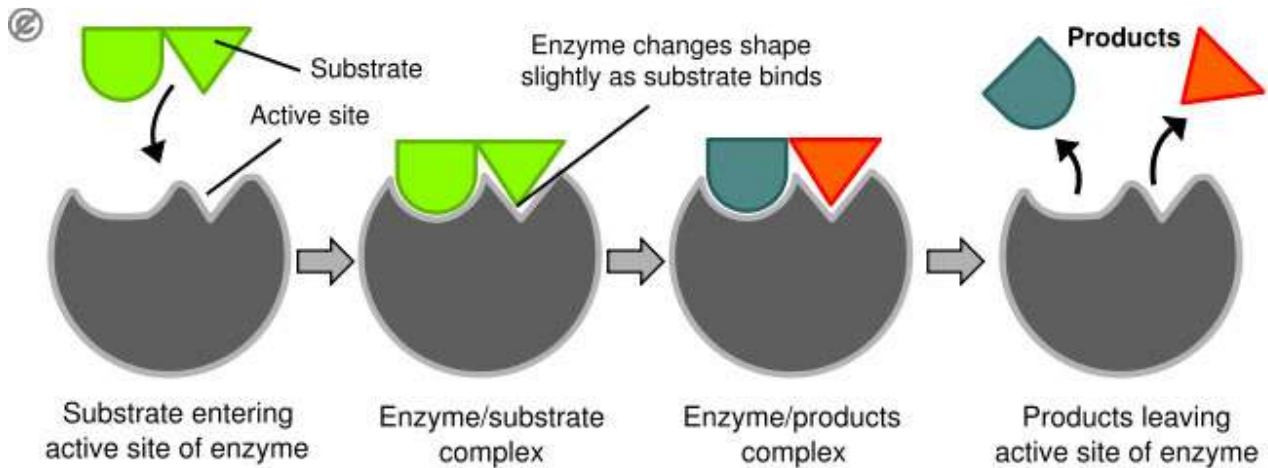

1. Initially, raising the temperature increases the rate of reaction.
2. However, after the **optimum temperature** is reached the enzyme begins to change shape and the **active site** stops being able to bind to the **substrate**.
3. The enzyme becomes **denatured** and stop working (the rate of reaction is zero at this point).

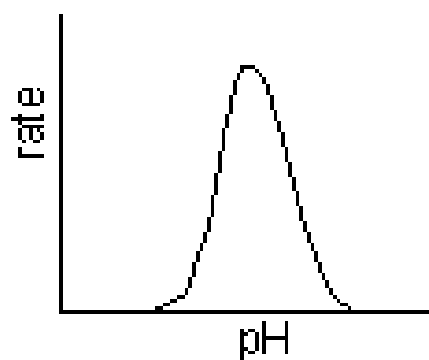

1. Initially, increasing the pH increases the rate of reaction.
2. However, after the **optimum pH** is reached the enzyme begins to change shape and the **active site** stops being able to bind to the **substrate**.
3. The enzyme becomes **denatured** and stop working (the rate of reaction is zero at this point).

*You need to be able to recall an experiment you have done that explores the effect of temperature on enzymes. An example is the enzyme **Catalase**, which breaks **Hydrogen peroxide** into **Water** and **Oxygen**:*



*Catalase is found in potatoes. Therefore, putting potato chips into peroxide will produce  $\text{O}_2$ . The rate of reaction is, therefore, proportional to the volume of  $\text{O}_2$  given off. Changing the temperature will alter the volume (i.e. initially increase it, reach an optimum, then decrease quickly as the **Catalase** becomes **denatured**).*

d) Movement of substances into and out of cells

**Diffusion** - the movement of molecules from high concentration to low concentration, down a concentration gradient.

**Osmosis** - the movement of water molecules from high concentration to low concentration through a partially permeable membrane

**Active Transport** - the movement of molecules from low concentration to high concentration against the concentration gradient. Energy is required for movement to occur.

Diffusion and osmosis occur because molecules have **kinetic energy**. The molecules constantly bounce off each other all the time, gradually spreading out. Eventually there will be an even mixture of molecules, which is called an **equilibrium**. Diffusion can be affected by:

- temperature (increases Kinetic energy)
- stirring (increases Kinetic energy)
- surface area for diffusion

- thickness / distance molecules have to diffuse
- the size of the concentration gradient
- the surface area to volume ratio

Plant cells are normally **turgid** (swollen full of water). This is important because it provides strength to plants. Plant cells have a **cell wall** to stop them bursting when turgid. When plant cells start to lose water they become **flaccid**. Flaccid plants lose their strength and start to wilt. Eventually, flaccid cells become **plasmolysed** as the cell membrane begins to peel away from the cell wall. This kills the cell.

*You need to give examples of diffusion and osmosis living and non-living situations. Good examples of diffusion are ink chromatography, or the diffusion of  $KMnO_4$  crystals (purple) into water. Diffusion of gases in the lung or leaf are also good examples. Osmosis can be shown artificially using visking tubing, or potato chips in salt solutions of different concentrations.*

## e) Nutrition

### Nutrition in Flowering Plants:

Plants are **photoautotrophic** (i.e. they generate their own "food" using energy from the Sun.) They do this through photosynthesis.

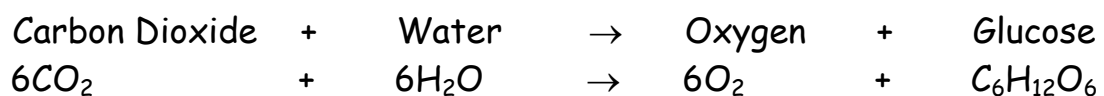

Through photosynthesis light energy is converted into chemical energy in the bonds in glucose. Plants use glucose for the following;

- **Respiration**
- Stored as **Starch**
- Turned into **Cellulose** (cellulose is a polymer of glucose)
- Used to make fats and oils

At any point the rate of photosynthesis can be increased by adding more  $CO_2$ , more water, more light or heating towards optimum temperature (photosynthesis is catalyzed by enzymes). However, at a certain point the addition of more e.g. light will not increase the rate of photosynthesis any further. This is because a second factor is limiting the rate of photosynthesis. Adding more of the **rate-limiting factor** will increase the rate further until another factor becomes limiting.

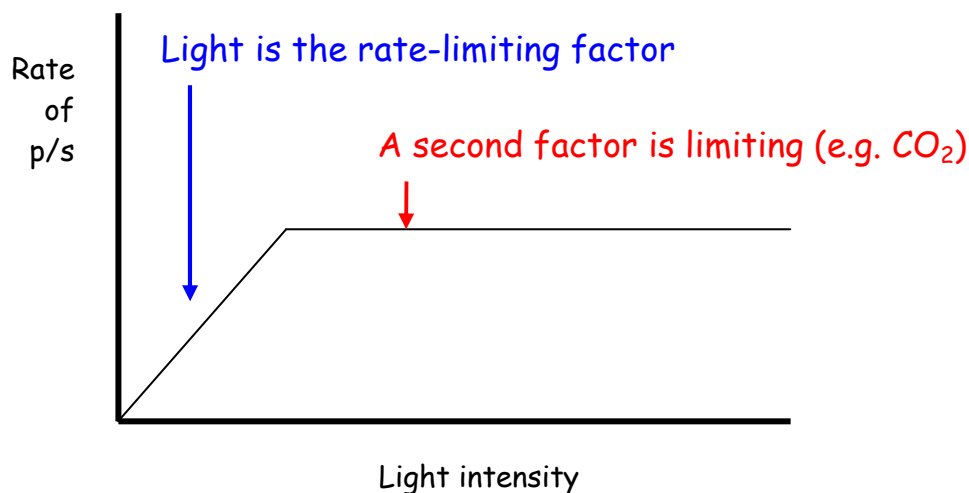

You need to know the parts of the leaf and their adaptations.

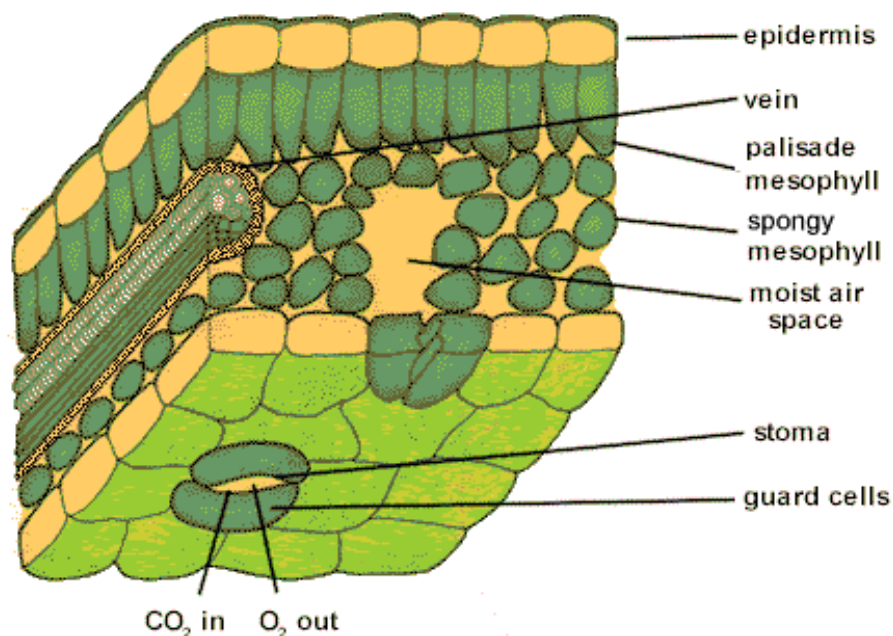

Leaf Structure	Adaptation for photosynthesis
Cuticle	Stops the leaf from losing water (remember, water is used in photosynthesis)
Epidermis	Transparent protective layer. Protects the leaf without inhibiting photosynthesis.
Palisade cells	Are packed full of chloroplasts. Are long and thin so light has to pass through as many chloroplasts as possible.
Air Spaces	Increase the surface area inside the leaf to maximise gas exchange across the surface of the Spongy Mesophyll cells
Stoma	Allow exchange of $CO_2$ and $O_2$
Guard Cells	Allow the stoma to open and close to stop the leaf losing too much water
Vein (containing <b>Xylem</b> )	Brings a steady supply of water to the leaf.

In addition to water and  $CO_2$  plants also need specific minerals;

**Nitrate** - used to make amino acids for use in plant proteins

**Magnesium** - forms part of the chlorophyll molecule

**Potassium** - essential for cell membranes

**Phosphate** - essential part of DNA and cell membranes

*You need to know an experiment that shows how the rate of p/s is affected by rate-limiting factors. The best example is using pond weed (**Elodea**) which produces bubbles of  $O_2$  as it photosynthesizes. The rate of bubble production is approximately proportional to the rate of photosynthesis. Therefore, when you add light or give it more  $CO_2$ , the rate of bubble production increases.*

*You also need to know an experiment that proves that light and  $CO_2$  are essential for the production of starch. A good example is the **Geranium** plant. It's leaves normally turn blue-black in the presence of iodine solution showing starch is present (you have to boil it in ethanol first to remove the chlorophyll to show the colour). However, if one leaf is put in aluminum foil and another is kept with lime water both **do not** turn blue-black, implying both  $CO_2$  and light are essential for starch production and, therefore, essential for p/s.*

## Nutrition in Humans:

Humans need to eat a **balanced diet**. This really means some of every **food group**, but not too much or too little of a particular one.

The two groups that provide energy (through respiration) are **lipids** and **carbohydrates**. Per mass lipids have about 10x more energy in them than carbohydrates. The energy in food is measured in **Calories** (equivalent to 4.2 kJ). In order to keep our bodies functioning (i.e. heart beating, basic respiratory requirement)

- Males need to consume **2500** Calories a day
- Females need to consume **2000** Calories a day

However, this will change if:

- You exercise
- You are growing
- You are ill
- You are pregnant
- You are old

*You need to know an experiment that can show how much energy there is in food. The easiest way of doing this is to burn a sample of food and use it to heat a fixed volume of water. If you record the change in temperature of the water you can use the equation below to find out the energy the food gave to the water;*

$$\text{Energy} = \text{change in temp.} \times \text{volume of water} \times 4.2\text{J/g/}^\circ\text{C}$$

*A potential problem is that not all the food will burn. To control this, you measure the start and end mass of the food and calculate the mass that actually burned. To standardize this, you can divide your calculated energy value by the change in mass to give you the change in mass **per gram of food** (which will allow you to compare values fairly between different food samples)*

You need to know the specific sources and functions of the following minerals and vitamins

Vitamin / Mineral	Function
Vitamin A	Present in <b>fish, cheese</b> and <b>eggs</b> . It forms an essential part of the pigment in <b>rods</b> and <b>cones</b> that detects light. Lack of Vitamin A can lead to blindness.
Vitamin C	Present in <b>citrus fruit</b> . It forms an essential part of <b>collagen</b> protein, which makes up skin, hair, gums and bones. Lack of Vitamin C causes scurvy.
Vitamin D	Present in <b>fish</b> , but made naturally by our body when sunlight shines on the skin. It is essential for regulating the growth of bones. Lack of Vitamin D can cause rickets.
Calcium	Present in <b>milk, cheese</b> & dairy foods. It is essential for bone growth and muscles. Lack of calcium can lead to osteoporosis.
Iron	Present in <b>red meat</b> and some <b>vegetables</b> (e.g. spinach). Is part of <b>haemoglobin</b> . Lack of iron causes anaemia.

### Digestive System:

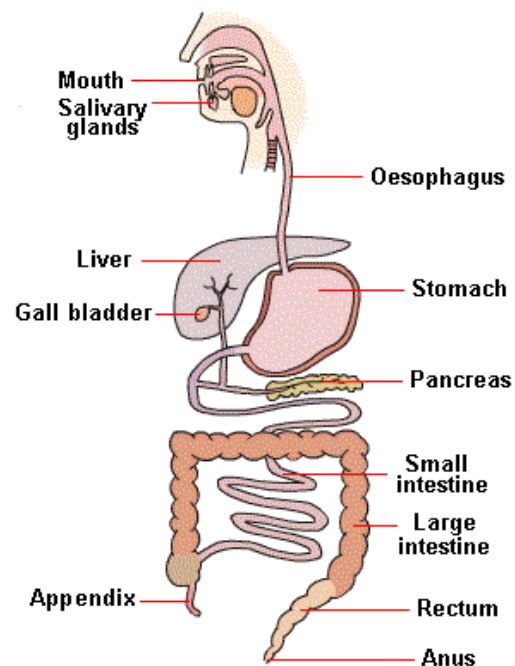

The purpose of digestion is to break food into molecules that are small enough to be absorbed into the bloodstream. There are two types of digestion;

**Mechanical Digestion**: digestion by physically breaking food into smaller pieces (i.e. not using enzymes). Carried out by;

- mouth and teeth chewing food
- stomach churning food

**Chemical Digestion**: digestion using enzymes

You need to know the following enzymes;

Where it is made	Where it works	Enzyme	Substrate	Products
Salivary Glands	Mouth	Amylase	Starch	Maltose
Stomach cells	Stomach	Protease	Protein	Amino Acids
Liver	Small Intestine	Bile Salts	Fat	Fat droplets
Pancreas	Small Intestine	Amylase Protease Lipase	Starch Protein Fat	Maltose Amino Acids Glycerol & Fatty acids
Small Intestine	Small Intestine	Maltase Protease	Maltose Protein	Glucose Amino Acids

**Bile salts** are not technically enzymes. They are made in the **liver** and stored in the **gall bladder**. They help by **emulsifying** lipid (i.e. turning large fat droplets into lots of tiny droplets). This increases the surface area, which helps lipase actually break the lipid down.

Bile also has a second job. Bile is **alkali**, which is important for **neutralizing stomach acid** as soon as it leaves the stomach. Stomach acid is important because it kills any bacteria that enter the stomach. Stomach acid does not play a significant role in digestion.



**Key Ideas:**

- Ingestion:** taking food into the digestive system
- Digestion:** breaking food down into molecules small enough to be absorbed into the bloodstream.
- Absorption:** taking molecules into the bloodstream. This happens almost entirely in the small intestine (ileum)
- Assimilation:** using food molecules to build new molecules in our bodies. I.e. the food molecule physically becomes part of our body.
- Egestion:** Removing unwanted food from the digestive system (having a poo!). This is **not excretion**, because the unwanted food has never, technically, been inside the body.
- Peristalsis:** the contraction of muscle in the intestine wall **behind a bolus** of food (ball of food). This pushes the bolus through the intestine.

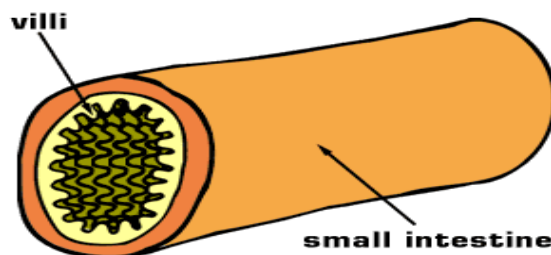
**Small intestine adaptations:**

Adaptation	Explanation
Thin wall	The intestine wall is thin, which speeds the rate of diffusion of molecules into the blood
Rich blood supply	This helps carry absorbed molecules away from the intestine quickly. This means there is always a low concentration of food molecules in the blood, which maintains a high concentration gradient
Intestine length	Roughly 7m long, which increases the surface area
Surface Area	<b><u>Villi</u></b> and <b><u>microvilli</u></b> increase the surface area of the small intestine by 1000x

## f) Respiration

Respiration is the process that releases energy into every living cell of every organism. The energy is essential for keeping the cell alive as it powers processes like protein synthesis, growth, repair, division etc.

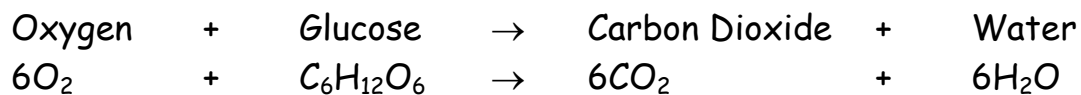

Some cells have the ability to respire without using oxygen. This is called **anaerobic respiration**. Only liver and muscle cells can do this in humans. Anaerobic respiration allows the cell to carry on working despite there being a shortage of oxygen (this is very useful in muscle cells - particularly if you are running for your life!)



Anaerobic respiration produces **Lactic Acid**, which is poisonous. Lactic acid builds up inside muscle cells and quickly leads to muscle fatigue and cramp. Eventually the muscle cell will stop working.

During recovery the lactic acid is transported to the liver via the bloodstream. The liver breaks the lactic acid into  $\text{CO}_2$  and water. Oxygen is required for this, which is called the **Oxygen Debt**.

**Yeast** also respire anaerobically, except they do not produce lactic acid like humans. Instead they make ethanol. This type of anaerobic respiration is also called **alcoholic fermentation**. It is used in the baking and brewing processes.

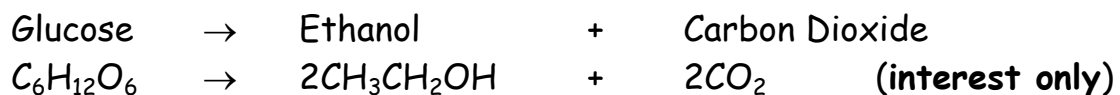

*You need to know an experiment that shows that living organisms produce  $\text{CO}_2$  through respiration. The best example is to suspend some maggots or seeds near the top of a test tube sealed with a bung (suspend the maggots / seeds in a wire mesh). A small amount*

of lime water in the bottom of the test tube will turn milky over time, indicating that  $CO_2$  has been produced.

g) Gas exchange

### Gas Exchange in Flowering Plants:

**Remind yourself of the structure of the leaf (Section 2e - Nutrition in Flowering Plants).**

Remember that  $CO_2$  and  $O_2$  diffuse in and out of leaves through stomata. Remember that  $CO_2$  is used in photosynthesis and produced by respiration, whereas  $O_2$  is used in respiration and produced in photosynthesis!

Both processes run all the time. So the net amount of glucose the plant produces (i.e. the amount it gets to use for growth etc) is governed by the formula;

Net Glucose = Total production - Amount used in respiration

The amount the plant uses in respiration is nearly constant. However, the total production is not. It is dependent on the rate-limiting factors (i.e. light intensity,  $CO_2$  level, water availability, temperature etc). In winter the net glucose production is virtually zero, whereas in summer the net glucose production is large. **Therefore, plants grow a lot during the summer and not much during winter!**

<b>Leaf Structure</b>	<b>Adaptation for gas exchange</b>
Air Spaces	Increase the surface area inside the leaf to maximise gas exchange across the surface of the Spongy Mesophyll cells
Stoma	Allow exchange of $CO_2$ and $O_2$
Mesophyll cells	Have a large surface area and moist surfaces, which speeds gas exchange
Leaf shape	Leaves are thin, which increases diffusion speeds and leaves also have a very large surface area, which also increases diffusion speed.
Stomata distribution	Stomata are spread out over leaves, which means waste gases produced by the leaf can diffuse away quickly, this stops the build-up of excreted products, which would slow gas exchange

*You need to know an experiment which will show the effect of light intensity on the rate of gas exchange. The best example is to seal two leaves (still attached to the plant) in separate plastic bags with some bicarbonate indicator solution. One of the bags is black and the other is translucent. The leaf in the black bag produces  $CO_2$  via respiration and the colour of the bicarbonate indicator changes quickly to yellow. The leaf in the translucent bag produces  $O_2$  via photosynthesis and the bicarbonate indicator solution changes to red slowly.*

*Bicarbonate Indicator colours:*

*Red in the presence of  $O_2$*

*Yellow in the presence of  $CO_2$*

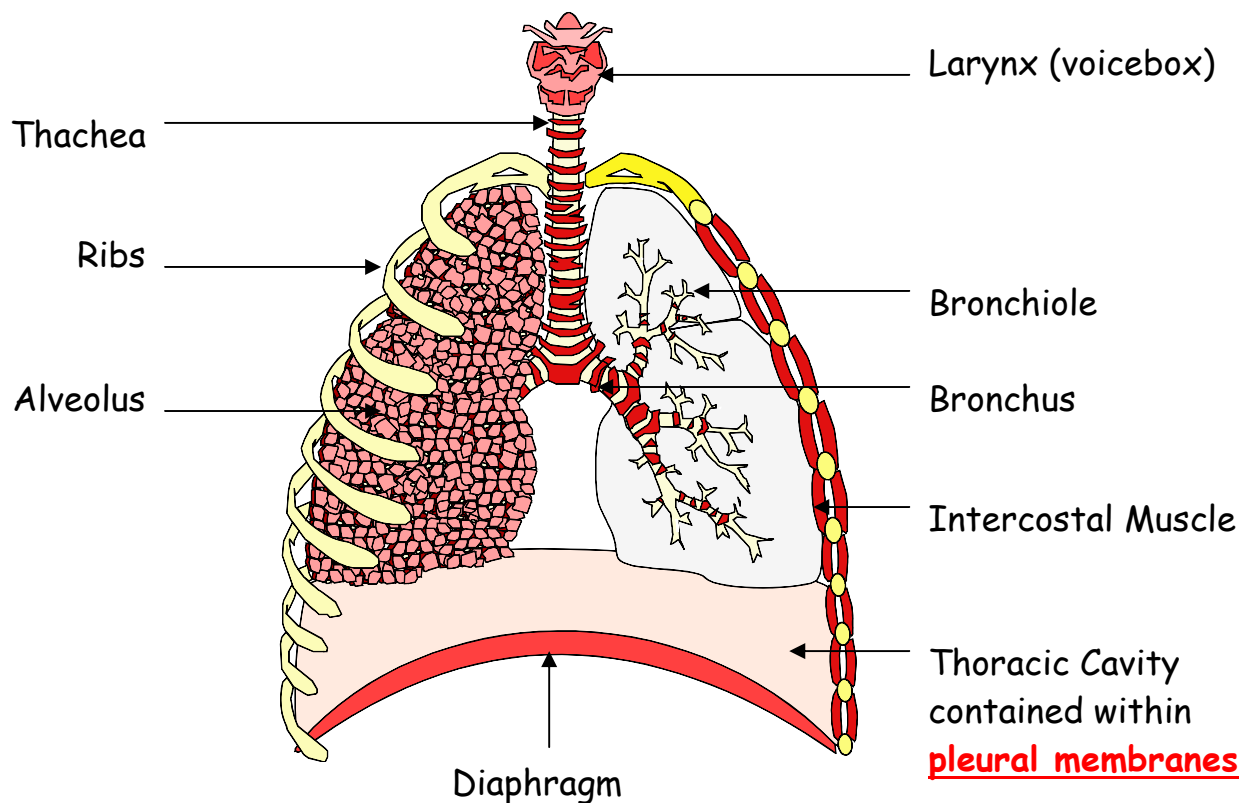
**Gas Exchange in Humans:****How breathing works**

<b>Breathing in (inhaling)</b>	<b>Breathing out (exhaling)</b>
<ol style="list-style-type: none"> <li>1. <b>Intercostal muscles</b> contract, pulling the <b>ribcage</b> forwards and out</li> <li>2. <b>Diaphragm</b> contracts moving down</li> <li>3. The volume of the <b>Thoracic Cavity</b> increases</li> <li>4. The <b>pressure</b> in the Thoracic Cavity <b>decreases</b></li> <li>5. Air is drawn <b>into</b> the lungs to equalize the pressure</li> </ol> <p>Inhaling is an active process, i.e. it requires energy for muscle contraction</p>	<ol style="list-style-type: none"> <li>1. Intercostal muscles relax, the ribcage moves <b>inwards</b> and <b>down</b></li> <li>2. Diaphragm relaxes moving <b>up</b></li> <li>3. The volume of the Thoracic Cavity <b>decreases</b></li> <li>4. The <b>pressure</b> in the Thoracic Cavity <b>increases</b></li> <li>5. <b>Air leaves</b> the lungs to equalize the pressure</li> </ol> <p>The entire process is passive, i.e. no energy is required as there is no muscle contraction.</p>

## Alveoli and their adaptations:

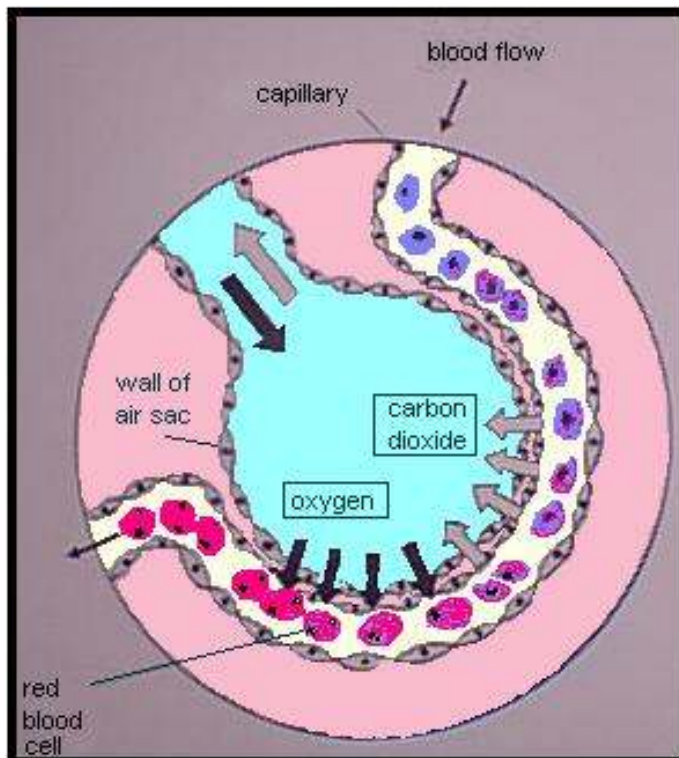

## Adaptations for gas exchange:

- Alveolus is one cell thick
- Capillary wall is one cell thick
- Many alveoli produce a huge surface area
- Alveoli wall is moist
- Breathing maintains a high concentration gradient for  $O_2$  and  $CO_2$
- Blood movement maintains a high concentration gradient for  $O_2$  and  $CO_2$

## Smoking:

Cigarette smoke contains **tar**, **nicotine**, **carcinogens**, **CO** and **poisons**

Chemical	Effect
Tar	Blocks up alveoli, making gas exchange more difficult. Also clogs up <b>cilia</b> (little hairs lining the lungs, whose job is to "wave" and remove mucus and trapped bacteria out of the lungs).
Nicotine	Speeds heart rate and damages arteries, causing furring of artery walls ( <b>atherosclerosis</b> ). This leads to heart disease and vascular diseases. It is also <b>addictive</b> .
Carcinogens	Damages the DNA of alveoli cells. This can lead to them reproducing faster than normal, which will cause a <b>tumour</b> to form. The tumour is the start of <b>cancer</b> .
Carbon Monoxide	Attaches permanently to haemoglobin, reducing the ability of the blood to carry $O_2$
Poisons	The list is endless. There are over 5000 poisonous chemicals in cigarette smoke (e.g. benzene, arsenic, lead, cyanide etc)

*You need to know an experiment that will show the effect of exercise on humans. The easiest experiment is to take your own heart rate, breathing rate and skin temperature at rest. Do some exercise, then take the same measurements again. You'll find they've all increased. The reason for this is that your rate of respiration has increased (to supply the muscles with extra energy for contraction). In order to get respiration to happen faster, you need more O<sub>2</sub>, so the breathing and heart rate increase. Unfortunately, you also release more waste heat energy, so your body heats up and you might have to start sweating to cool it down again.*

## h) Transport

All organisms respire (well, nearly all, but according to your syllabus they all do). Therefore, all organisms need to **exchange gases** with their environment.

Unicellular organisms: exchange gases directly through their cell membrane. They can do this because their surface area is large compared to their volume (**large SA:Vol ratio**). They do not need a circulatory system.

Multicellular organisms: cannot exchange gases directly through their skin. Their surface area is very small compared to their volume (**small SA:Vol ratio**); therefore, they need to have specialized gas exchange organs (e.g. leaf, lung and gill) and a **circulatory system**.

### Transport in Flowering plants:

Plants have two different networks of tubes inside them;

**Phloem**: transports **sucrose** and **amino acids** up and down the stem

**Xylem**: transports **water** and **minerals** up the stem

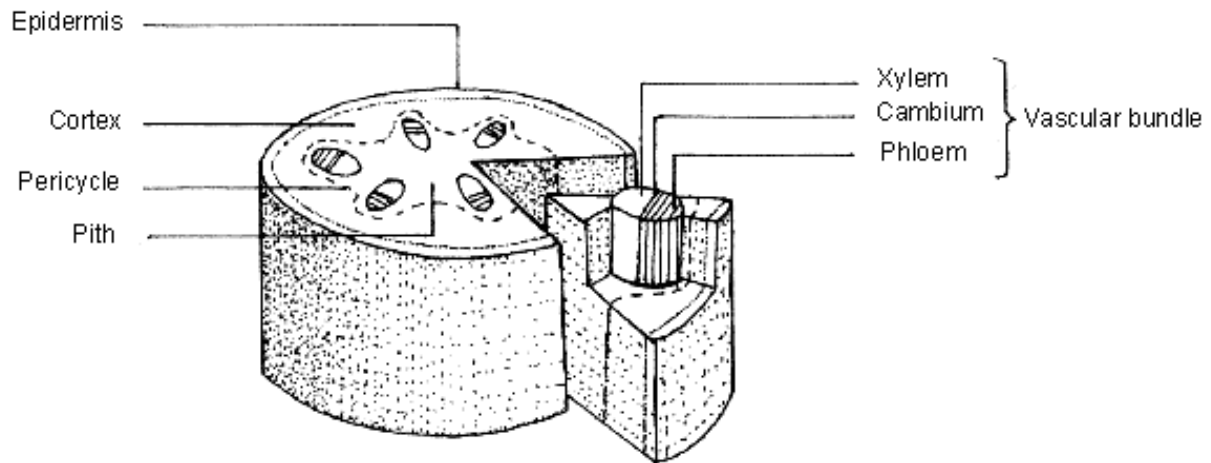

Phloem and Xylem are arranged in separate bundles (**vascular bundles**) inside the stem. The xylem is on the **inside** and the phloem is on the **outside**. This arrangement is different in roots (but you don't need to know it)

Transport in the phloem is tricky, but fortunately not on your syllabus. It is **not** the same as transport in the xylem, which occurs by the process of **transpiration**.

**Transpiration** is the movement of water up a plant, from the roots, through the stem and finally out of the leaves.

In the Roots:

Water enters root hair cells by **osmosis**. The roots are full of **minerals**, which artificially lower the concentration of water inside the root cells, so water is always drawn into them from the soil. This enables transpiration to happen even if the soil is **very dry**. The roots take the minerals up against the concentration gradient and is, therefore, an example of **active transport**.



Root hair cells increase the root's surface area



In the Stem:

1. Water evaporates out of the top of the xylem
2. This generates a low pressure at the top of the xylem (a mini vacuum, if you like)
3. This sucks water molecules up the xylem
4. This is called **transpiration pull**

Extension (not on syllabus, but very interesting...)

Water molecules are slightly charged (**polar**). The oxygen atom is slightly negative and the hydrogens are slightly positively charged. This means that water molecules tend to stick to each other. Therefore, when transpiration pull sucks at the water molecules in the top of the xylem, the entire column of water moves up the xylem, not just the molecules at the top!

In the leaf:

Water enters the leaf in xylem vessels in veins (basically, another name for a leaf vascular bundle). The water moves by **osmosis** into leaf mesophyll cells, where it **evaporates** into the air spaces and finally **diffuses** out of the stomata into the air.

Factors affecting the rate of transpiration:

Factor	Effect on transpiration rate
Temperature (increases transpiration)	Increasing temperature increases the <b>kinetic energy</b> of molecules. This makes diffusion, osmosis and evaporation happen faster
Humidity (decreases transpiration)	When the air is humid then there is more water vapour in it. Humid air is less able to accept more water molecules by evaporation.
Wind (increases transpiration)	Wind blows water vapour away from the stoma, keeping the concentration gradient high.
Light intensity (increases transpiration)	Light causes stoma to open. Wider stoma can allow faster diffusion of water vapour out of the leaf.

You need to know an experiment that can show the effect of the above factors on the rate of transpiration. The best experiment is a **potometer**, which measures how quickly a little bubble of air moves up a glass tube attached to the bottom of the stem. Adding a fan, changing the humidity, increasing the temperature etc will all change the speed the bubble moves up the tube.

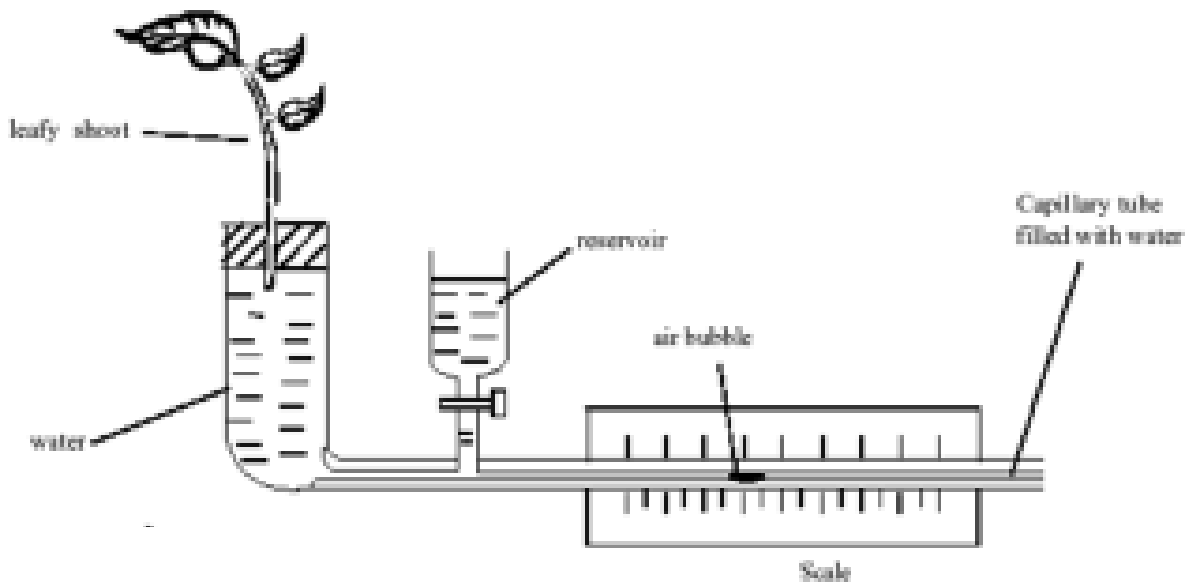

### Why do plants need water (why do they bother to transpire)?

- Used in photosynthesis (~10%)
- A solvent for transporting other things (e.g. minerals) (~10%)
- Used in chemical reactions (~5%)
- A site of chemical reactions (~5%)
- **Cooling the plant (~70%)**

## Transport in Humans:

Blood consists of 4 main parts;

**Plasma** - mostly water used for **transporting** things around the body (i.e. **CO<sub>2</sub>**, **glucose**, **amino acids**, other products of digestion, **urea**, **hormones** and **heat energy**).

**Red Blood Cells** - adapted to carry O<sub>2</sub> around the body. O<sub>2</sub> attaches to **haemoglobin** protein, which the RBCs are filled with. Other adaptations of RBCs include;

- Smooth edges
- **Biconcave** shape (increases surface area and allows folding)
- Made in huge quantities
- No nucleus (so more room for haemoglobin)

**Platelets** - help clot the blood. This stops blood loss and also prevents microorganisms entering the body.

**White Blood Cells** - are part of the immune system. There are two main types; **macrophages** and **lymphocytes**.

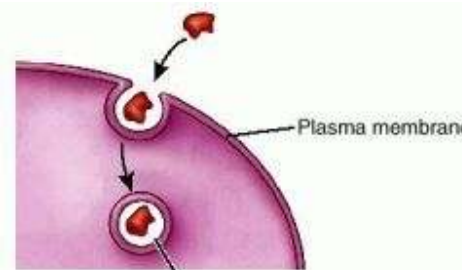
<b>Macrophages</b> (sometimes called Phagocytes)	<b>Lymphocytes</b>
<p>Travel in the blood. They detect foreign bodies (i.e. foreign cells, toxins, cells infected with virus and cancerous cells) and <b>engulf and destroy</b> them.</p>  <p>Engulfing and destroying is called <b>phagocytosis</b></p>	<p>Stay in the lymph system (you don't need to know what this is). They make <b>antibody proteins</b> in large numbers. Antibody proteins travel in the blood and stick to foreign objects. This helps because;</p> <ol style="list-style-type: none"> <li>1. foreign objects are stuck to each other, stopping them spreading</li> <li>2. Macrophages can engulf many foreign objects at the same time, speeding up the killing process</li> </ol>

Extension (not technically on syllabus, but not sure...)

Plasma carries  $CO_2$  around the body. How?

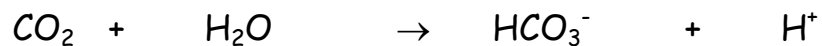

The  $CO_2$  reacts with water molecules to produce the **Hydrogen Carbonate ion**. In the lungs the reaction reverses to produce  $CO_2$  again.  $CO_2$  is, therefore, carried as an **aqueous ion** in the blood plasma.

The Human Heart:

You need to know;

1. the names of the 4 **chambers** of the heart
2. the names of the 2 **arteries** and 2 **veins** attached to the heart
3. The names of the two sets of **valves** in the heart

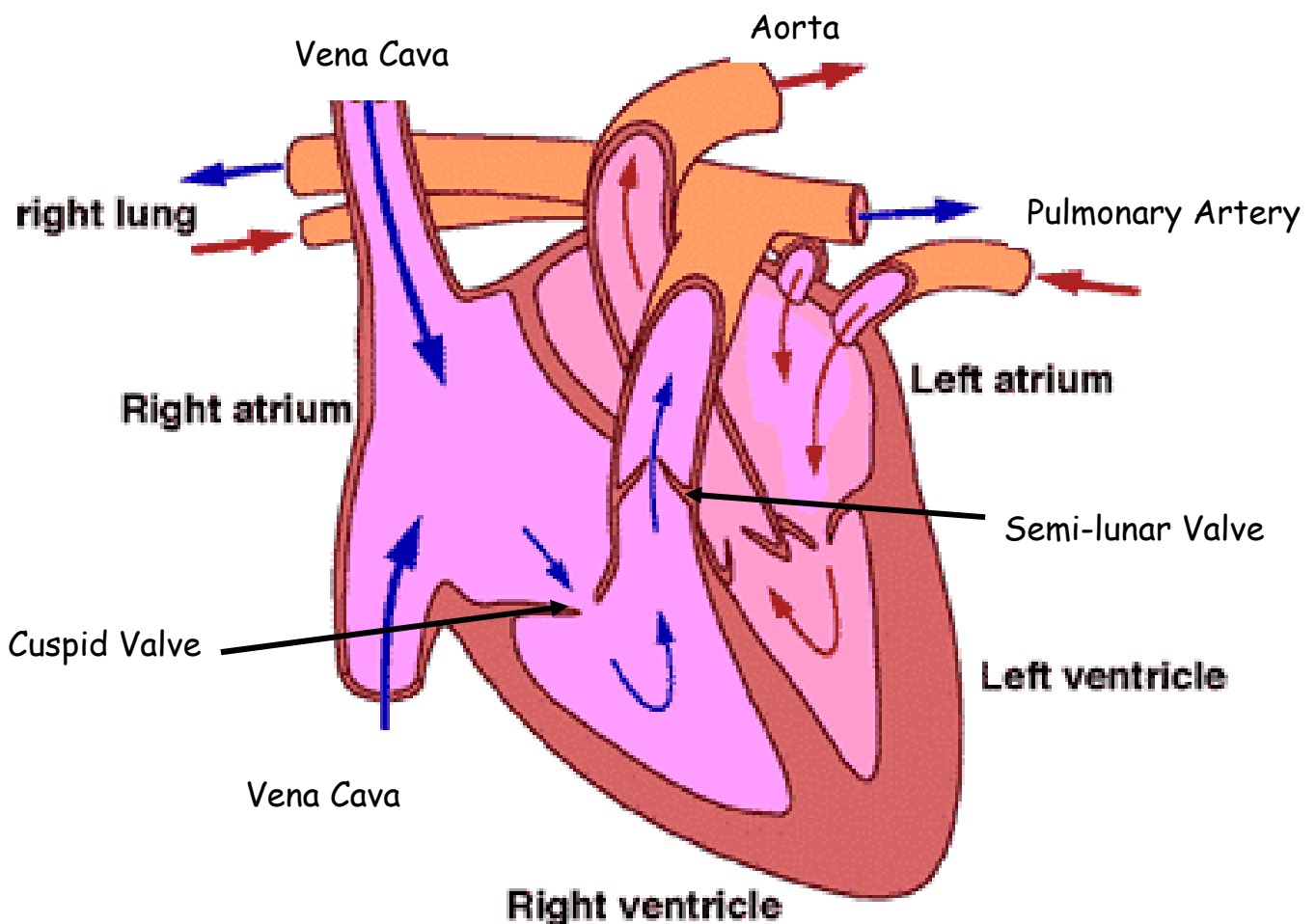

### Contraction in the heart:

**Remember, the atria contract first. The L & R atria contract at the same time. The ventricles contract second. The L & R Ventricles contract at the same time.**

1. Blood enters the atria
2. Both atria start to contract, pushing the blood into the ventricles through the open cuspid valves
3. When the ventricles are full they begin to contract
4. The cuspid valves shut to stop **backflow**
5. Blood is forced out of the heart into the circulatory system through the open semi-lunar valves
6. When the ventricles finish contracting the S-L valves shut, stopping backflow.

Blood has to pass through the heart twice to complete a full circuit of the body (takes about 10 - 20sec). This is called a **double circulation**.

During exercise **adrenaline** is released from the **adrenal glands**. Adrenaline has two effects of the heart;

1. Makes it beat **faster**
2. Makes each beat **harder**

The combined effect is to **massively increase** the volume of blood pumped by the heart per minute.

#### Extension (summarizes point above mathematically )

$$\text{Cardiac Output} = \text{Heart Rate} \times \text{Stroke Volume}$$

CO = Volume of blood pumped per minute

HR = No of beats per minute

SV = Volume of blood ejected per beat

Adrenaline increases both HR & SV, therefore, increasing CO **lots**

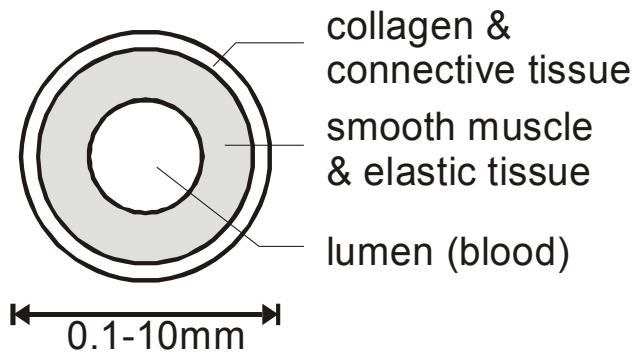
Artery, Vein and Capillary:Artery:

Arteries carry **high pressure blood** **away** from the heart.

Key Points:

1. Thick muscle layer to withstand high pressure blood
2. Elastic tissue allows artery to stretch when blood is forced into it
3. Protective collagen layer
4. Round shape
5. Relatively small lumen

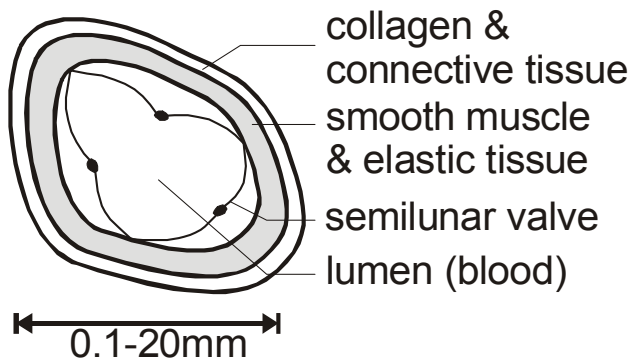
Vein:

Veins carry **low pressure blood** **towards** the heart.

Key Points:

1. Thin muscle layer (low pressure blood)
2. Valve to stop **backflow**
3. Protective collagen layer
4. Not a round shape (wall not thick enough to hold shape)
5. Large lumen (decreases effect of friction)

## Capillary:

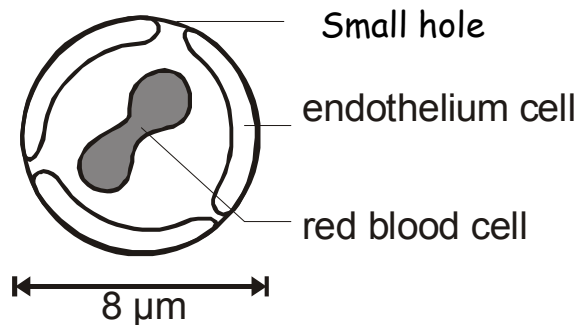

Capillaries are adapted for **exchange** - they are not connected directly to the heart.

### Key Points:

1. Walls are **one cell thick** (cells are called endothelial cells)
2. Lumen is the same width as one RBC (therefore more of RBC in contact with wall, therefore smaller diffusion distance)
3. No muscle or elastic tissue
4. Tiny (compare the scales and remind yourself what a  $\mu\text{m}$  is)

### Something extra you're supposed to know:

The vessel taking blood to the kidneys is the **renal artery**

The vessel taking blood away from the kidneys is the **renal vein**

The vessel taking blood to the liver is the **hepatic portal vein**

The vessel taking blood away from the liver is the **hepatic vein**

**Hepatic Portal Vein?** The blood that goes to the liver comes directly from the gut, **not from the heart**, therefore, it's not an artery but a **portal vein**.

**Why does this happen?** It makes sense to send all blood from the gut directly to the liver because if there are any poisons in what you've eaten they get broken down by the liver **before** going around the body. Cunning, eh?

## i) Excretion

**Excretion: the removal of waste products of metabolism from living organisms**

### Excretion in Flowering plants:

$CO_2$  and  $O_2$  are excreted by leaves via the **stomata**.  $O_2$  is excreted during photosynthesis and  $CO_2$  is excreted during respiration

### Excretion in Humans:

Humans have 3 main excretory organs;

1. Lungs - excrete  $CO_2$  and  $H_2O$
2. Skin - excretes  $H_2O$
3. Kidneys - excrete  $H_2O$ , **urea**, **excess minerals** and other wastes.

#### Extension - what's urea? (not technically on syllabus)

We need to have a certain amount of protein in our diet to supply the amino acids we need to make our own body proteins. However, we usually eat far more than we need, so we must excrete the rest.

**Problem:** when amino acids are broken down they make **ammonia**, which is very toxic.

**Solution:** the **liver** turns the ammonia into **urea**, which is harmless.

**Therefore urea is a product of the metabolism of amino acids.**

### The Kidney:

The functional unit of the kidney is the **nephron**. There are millions of nephrons in a single kidney.



Nephrons have 2 jobs;

**Excretion** - filtering the blood and reclaiming the "good bits"

**Osmoregulation** - balancing the water level of the body (water homeostasis)

A Nephron:

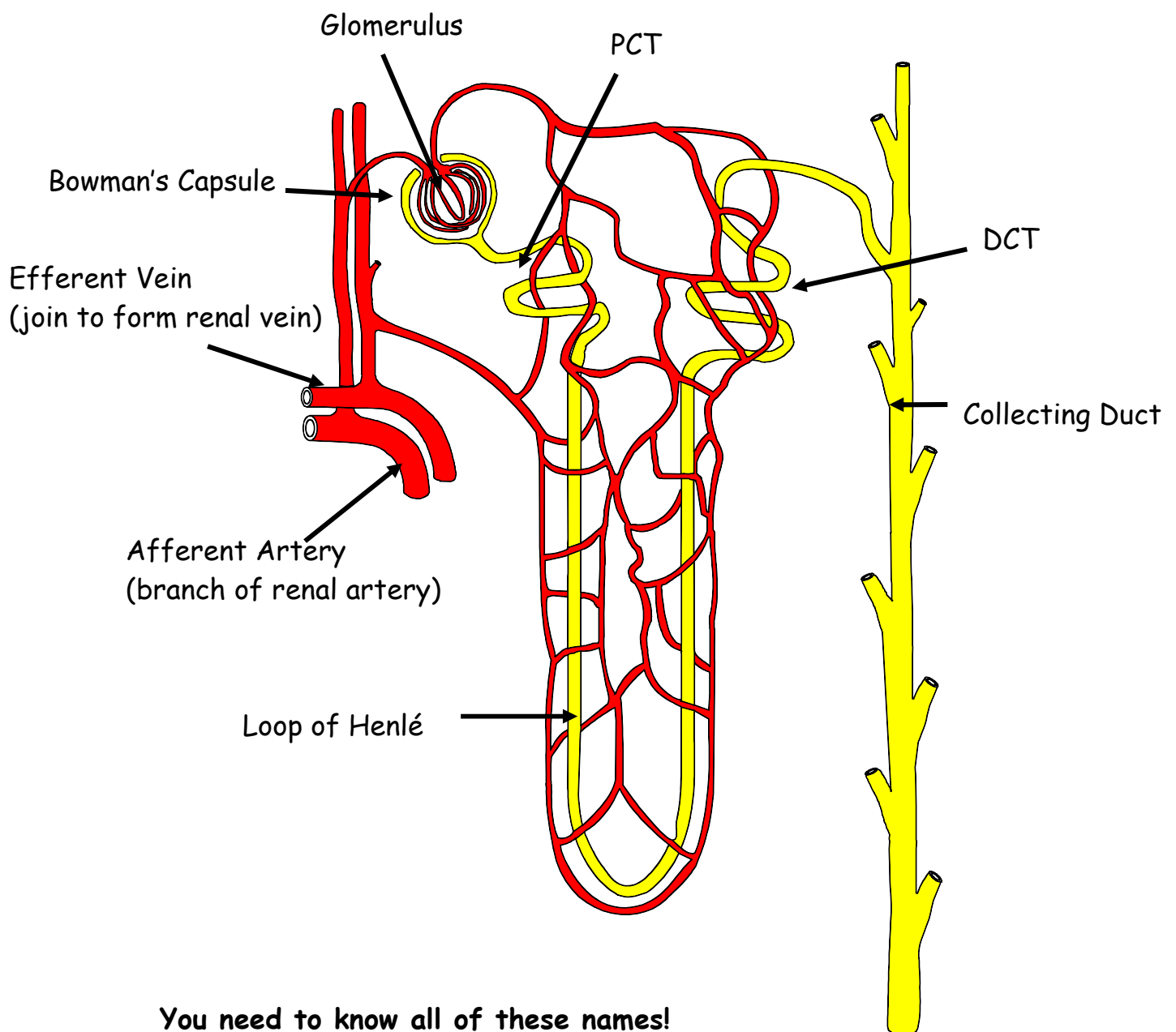

**You need to know all of these names!**

### How the nephron works:

1. Dirty blood enters the kidney via the afferent artery
2. The artery splits up into a ball of capillaries, called the glomerulus
3. The blood is under high pressure, so all small substances are forced out of the holes in the capillary walls. Only large proteins and cells stay behind.
4. The small substances (glucose, minerals, urea, water etc) move into the bowman's capsule, which wraps around the glomerulus
5. The capsule leads into the PCT, which re-absorbs all glucose via **active transport** (i.e. it selectively removes the glucose from the nephron and returns it to the blood)
6. The PCT leads to the Loop of Henlé, which re-absorbs the water by **osmosis**
7. The Loop leads to the DCT, which re-absorbs all minerals, amino acids and other "useful" substances by **active transport**
8. The remaining fluid (containing excess water, excess minerals and urea) passes into the collecting duct
9. The collecting ducts from other nephrons join and form the **ureter**, which leads to the bladder
10. The fluid is now called urine and is stored in the bladder for excretion
11. The bladder takes the urine to the outside world via the **urethra**

This is the first role of the nephron (it's role in **excretion**). Remember, the nephron has a second role in **osmoregulation**.

Blood water levels are sensed by the **hypothalamus** in the brain. When water levels are **too low**, the hypothalamus tells the **pituitary gland** (also in the brain) to release the hormone Anti-Diuretic Hormone (**ADH**)

### When blood water levels are too low:

1. **Hypothalamus** detects
2. **Pituitary** gland releases ADH into bloodstream
3. **ADH** travels all over the body
4. Only the cells in the **collecting duct** of the nephrons of the kidney have **receptors** for ADH, so only they respond to the hormone
5. The collecting duct becomes **more permeable**
6. Water is draw **out** of the collecting duct back into the blood
7. Water levels return to normal

When water levels are too high exactly the opposite happens (i.e. the pituitary releases less ADH)

### j) Coordination and response

#### **Homeostasis: the maintenance of a constant internal environment**

All organisms try and maintain a constant internal environment. This is called **homeostasis**. Examples of homeostasis include the regulation of water levels (see above) and the regulation of body temperature (see below).

Humans have two systems which carry out homeostasis:

**Nervous System** - immediate responses to stimuli (sec - hours)

**Endocrine System** - long term responses to stimuli (hours - months)

Both systems respond to **stimuli** (i.e. events that change the internal environment). Both systems have a **detector** (which detects the stimulus) and an **effector**, which carries out a response to correct the effect of the stimulus. The message from detector to effector is carried either via an electrical nerve impulse or as a hormone, depending which homeostatic system is being used.

## Coordination in Humans:

### Nerves & the Nervous system:

The nervous system consists of the **brain** and the **spinal cord**. Sense organs (e.g. pain receptors in skin, or photoreceptors in the eye) are linked to the brain via **nerves**.

Stimulation of the sense organs results in an electrical signal (a **nerve impulse**) being sent along the nerve to the brain. Nerve impulses are very quick (~120m/s), allowing rapid responses to the stimulus

Some sense organs are not connected directly to the brain. This is a defense mechanism allowing almost instant responses to threatening or dangerous stimuli (e.g. pain). These instant responses are controlled by nerves in the spine, rather than the brain and are called **reflexes**

### A reflex arc:

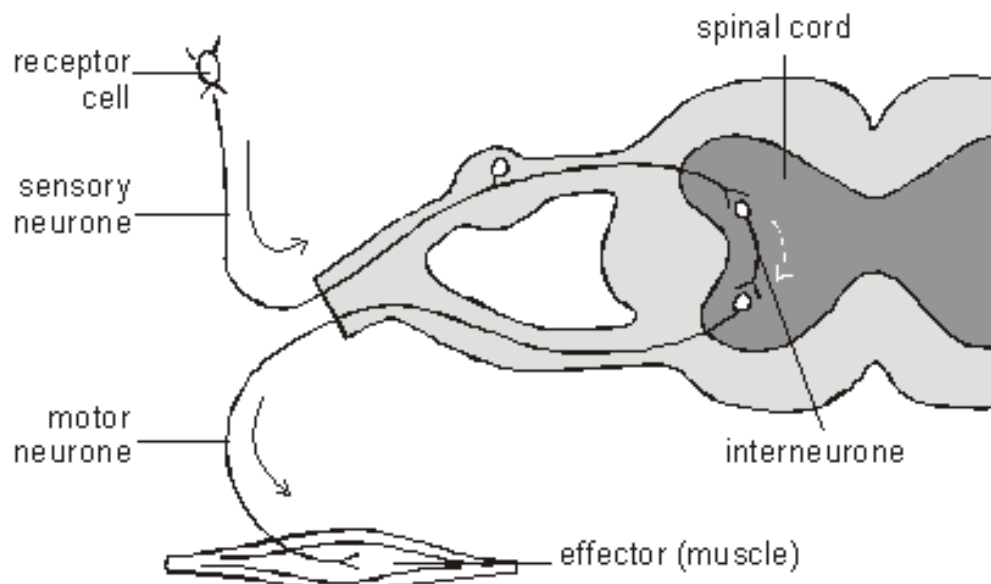

1. A **stimulus** is detected by a **receptor**
2. The receptor initiates a nerve impulse in the **sensory nerve**

3. The sensory nerve (which runs from the receptor to the spine) passes the message onto an **interneurone** in the spine
4. The interneurone passes the message on the a **motor nerve**
5. The motor nerve (which runs from the spine to a muscle in the same limb as the receptor) passes the message onto the **effector** muscle
6. The effector muscle carries out the **response**.

The entire process (stimulus to response) happens in less than a second and does not involve the brain. The purpose of the interneurone is to inform the brain of what has happened.

### Reflexes in the eye:

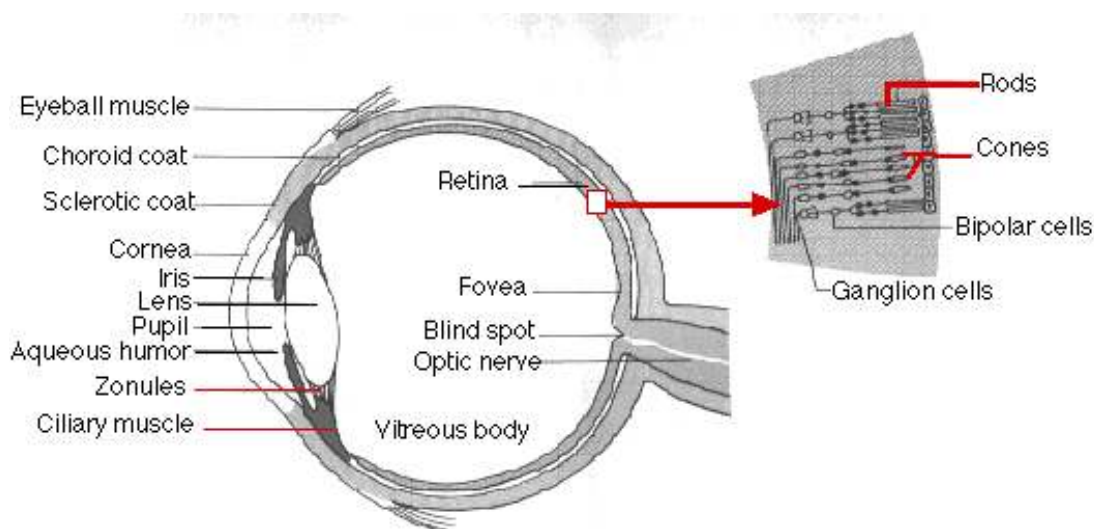

Structure	Function
Cornea	Refracts (bends) light entering the eye.
Iris	Controls the amount of light entering the eye by adjusting the size of the pupil.
Pupil	Hole which allows light into the eye.
Lens	Allows fine focusing by changing shape.

Ciliary muscle	Changes the shape of the lens by altering the tension on the suspensory ligaments.
Retina	Contains light-sensitive rod and cone cells which convert light energy into a nerve impulse (i.e. transduce energy).
Fovea	Area where most light is focused, very sensitive to colour (most cones here).
Optic nerve	Transmits nerve impulses to the brain, where they are interpreted.
Sclera	Outer protective layer of eye
Choroid	Contains blood vessels

Light is detected by **photoreceptors** in the eye. These receptors form the **retina** (the inner lining of the eye). There are two types of photoreceptor;

- **Rods**, which see only in black & white
- **Cones**, which see in either red, blue or green (3 types of cone)

There are two types of reflex you need to know about in the eye;

1. Responding to different light levels
2. Focusing the eye

Responding to different light levels:

In the dark	In the light
<ol style="list-style-type: none"> <li>1. Photoreceptors detect</li> <li>2. Reflex occurs</li> <li>3. Muscles in the <b>Iris</b> are the effectors <ul style="list-style-type: none"> <li>- <b>Radial muscles</b> in Iris contract</li> <li>- <b>Circulatory muscles</b> in Iris relax</li> </ul> </li> <li>4. Pupil diameter opens</li> <li>5. More light enters the eye</li> </ol>	<ol style="list-style-type: none"> <li>6. Photoreceptors detect</li> <li>7. Reflex occurs</li> <li>8. Muscles in the <b>Iris</b> are the effectors <ul style="list-style-type: none"> <li>- <b>Radial muscles</b> in Iris relax</li> <li>- <b>Circulatory muscles</b> in Iris contract</li> </ul> </li> <li>9. Pupil diameter closes</li> <li>10. Less light enters the eye</li> </ol>

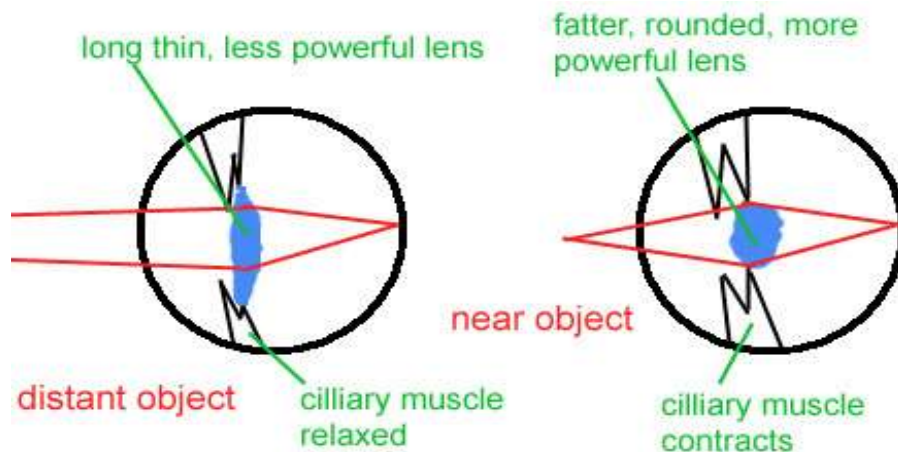
Focusing the eye:

Far Object	Near Object
<ol style="list-style-type: none"> <li>1. Incoming light is <b>parallel</b></li> <li>2. <b>Ciliary muscles</b> relax</li> <li>3. <b>Suspensory ligaments</b> are tight</li> <li>4. Lens is pulled <b>thin</b></li> <li>5. Light is <b>refracted</b> less</li> </ol>	<ol style="list-style-type: none"> <li>5. Incoming light is <b>divergent</b></li> <li>6. <b>Ciliary muscles</b> contract</li> <li>7. <b>Suspensory ligaments</b> are loose</li> <li>8. Lens becomes <b>fat</b></li> <li>9. Light is <b>refracted</b> more</li> </ol>
Light converges on the retina	Light converges on the retina

Controlling Skin temperature:

Too hot	Too cold
When you are hot the following happen (controlled by reflexes);	When you are cold the following happen (controlled by reflexes);
<ol style="list-style-type: none"> <li>1. Hairs on skin lie flat (less <b>insulating air</b> trapped)</li> <li>2. <b>Sweating</b> starts</li> <li>3. Blood is diverted close to the surface of the skin (more heat <b>radiation</b>)</li> </ol>	<ol style="list-style-type: none"> <li>1. Hairs on skin stand up (more <b>insulating air</b> trapped)</li> <li>2. <b>Sweating</b> stops</li> <li>3. <b>Shivering</b> starts, so muscles respire more, producing more heat</li> <li>4. Blood is diverted away from the surface of the skin (less heat <b>radiation</b>)</li> </ol>

## How is blood diverted?

Arterioles in the skin can open and close in response to nerve messages.

**Vasoconstriction** - arteriole closes

**Vasodilation** - arteriole opens

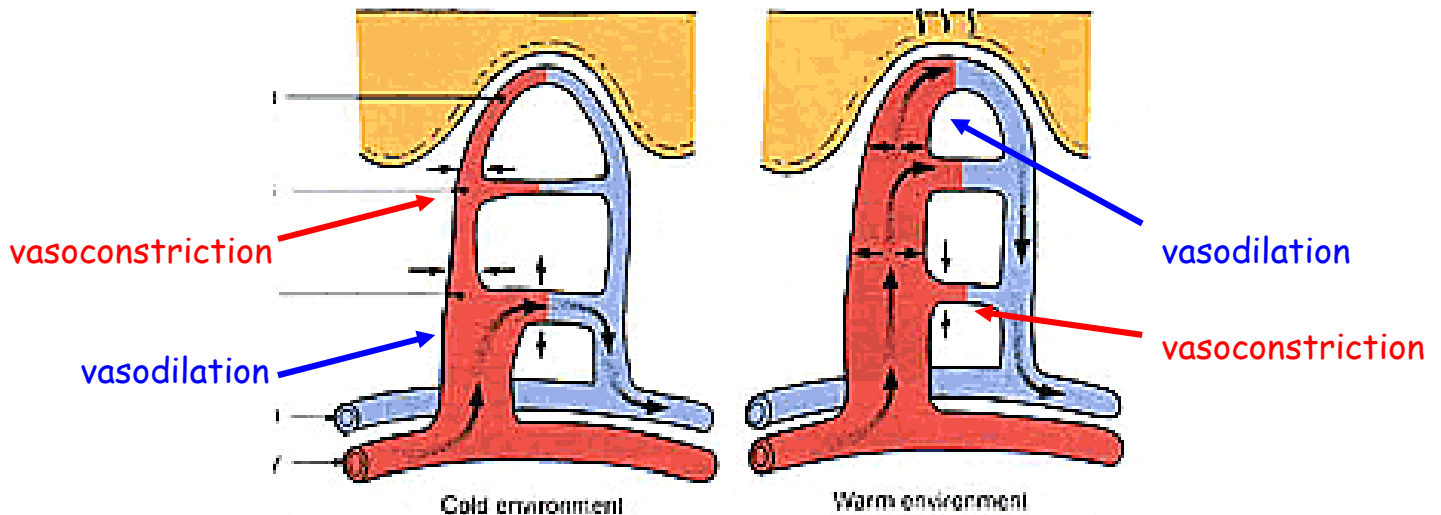

The net effect is to open arterioles under the surface of the skin when hot and close them when cold.

## Random Hormones you need to know:

Hormone	Source	Effect
ADH	Pituitary	Regulated blood osmolarity (see above)
Adrenaline	Adrenal glands	Increases heart rate and breathing rate during exercise (more O <sub>2</sub> for respiration)
Insulin	Pancreas	Decreases blood glucose level after a meal
Testosterone	Testes	Triggers puberty in boys (see next section)
Progesterone	Ovaries	Maintains uterus lining and (indirectly) causes <b>menstruation</b>
Oestrogen	Ovaries	Triggers puberty in girls (see next section) Stimulates growth of uterus lining each month and (indirectly) causes <b>ovulation</b>

It might be worth your while looking these up in more detail...



## Coordination in Flowering plants:

Plants also respond to stimuli. As plants don't have nerves their responses are limited to hormones only. Plants respond to the following stimuli

- **Gravity**. Roots grow towards gravitational pull and stems grow away. This is **Geotropism**.
- **Water**. Roots grow towards water. This is **Hydrotropism**.
- **Light**. Shoots grow towards light. This is **Phototropism**.

Phototropism is controlled by hormones released by the **growing tip** of the shoot. Only the tip makes the hormone. If you remove the tip, the shoot stops growing. The hormone made by the tip is called **Auxin**.

*You need to know an experiment that demonstrates Geotropism. The best example is to grow a runner bean seed in a jam jar. Let the root start to grow downwards then rotate the seed 90°. The root will then start growing at 90° to its original direction. A more advanced (and less practical) experiment that shows geotropism is that seeds germinating inside spacecraft have roots that grow randomly!*

*You also need to know an experiment that demonstrates Phototropism. The best example is to repeat the example above, but look at the growth of the shoot!*

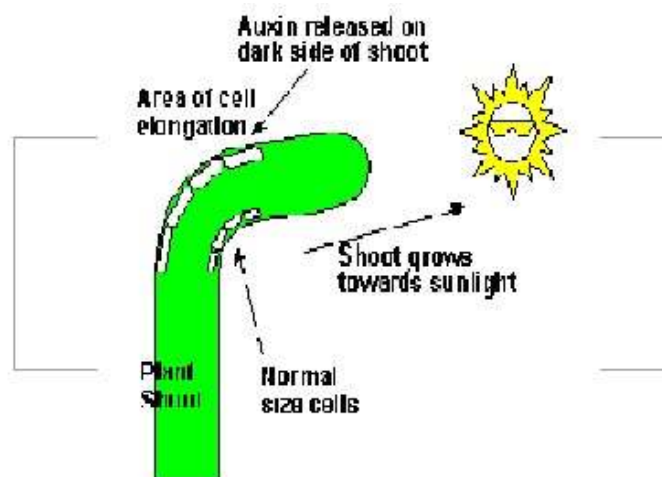

## Section 3: Reproduction and inheritance

### a) Reproduction

There are two types of reproduction;

**Sexual:** reproduction in which two **gametes** (sex cells) fuse to create a new offspring that is **genetically different** to the parents. Two parents are involved.

**Asexual:** reproduction **without** fusion of gametes. It involves one parent only and produces offspring that are **genetically identical** to the parent.

**Two definitions to learn:**

**Fertilization:** the process in which a male and a female gamete fuse to form a zygote

**Zygote:** a cell that is the result of fertilization. It will divide by mitosis to form an **embryo**.

### Reproduction in Flowering plants:

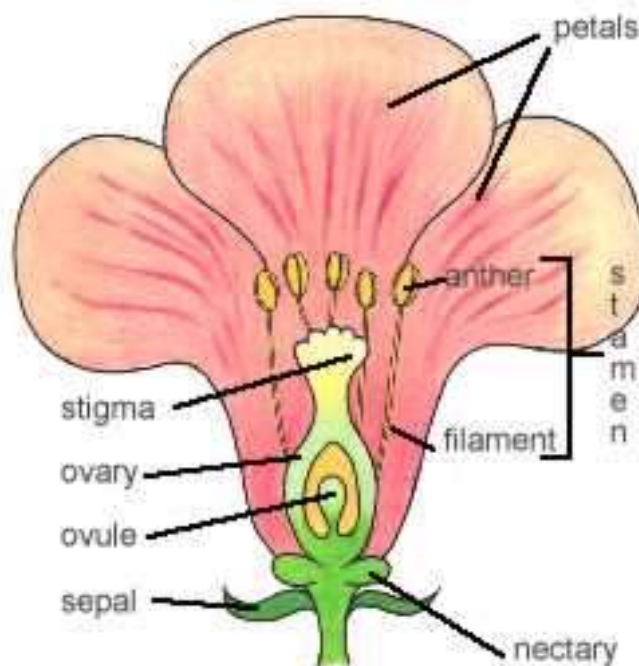

Part	Function
Petal	Colourful part of the flower. Attracts insects in insect-pollinated plants
Anther	Male part of the plant. Makes pollen.
Filament	Joins the anther to the rest of the flower.
Stigma	Female part of the plant. Receives pollen.
Ovary	Contains the ovules
Ovule	Eggs - female gametes
Pollen	Male gamete
Nectary	Makes nectar to attract insects in insect-pollinated plants
Sepal	Protects the flower when it is in bud

### Wind Pollinated

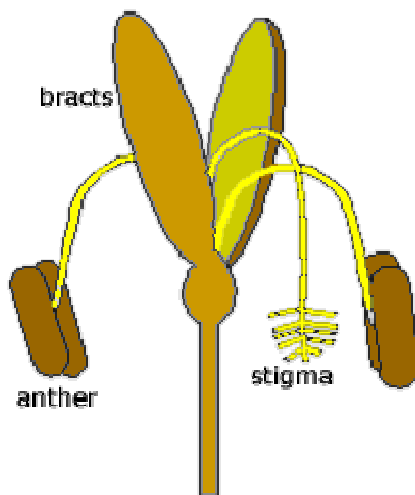

- Anthers are large and outside the flower
- Stigma is large and outside the flower
- Tiny colourless petals
- Pollen made in huge quantities
- No nectary

### Insect Pollinated

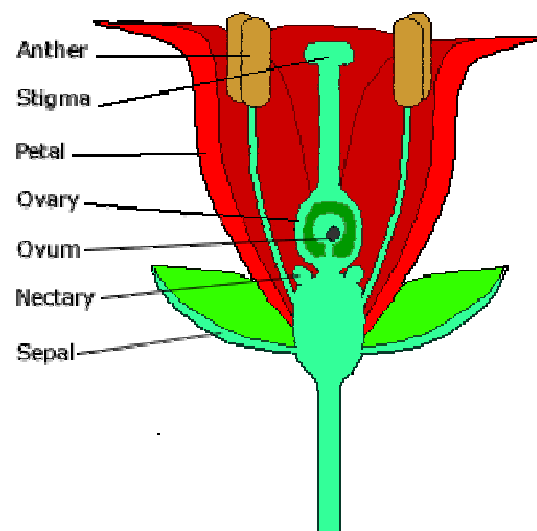

- Anthers are small and inside the flower
- Stigma is small and inside the flower
- Large colourful petals
- Has a nectary

**Pollination:** the deposition of pollen from the anther of one flower onto the stigma of a different flower of the same species.

When pollination occurs, the pollen grows a **pollen tube** down the stigma of the flower. The pollen tube carries the **nucleus** of the pollen into the ovary, where it fuses with an **ovule** (fertilisation).

When fertilization has happen the flower will change in the following ways:

1. Petals die and fall away
2. Fertilized ovule turns into a **seed**
3. Ovary may fill with sugars and turn into a **fruit**

In order to **germinate** (grow into a new plant) seeds need the following conditions:

- Presence of water
- Presence of O<sub>2</sub> (seed needs to respire)
- Correct temperature (recall enzymes work at optimum temp)

When a seed germinates the cells inside it start to grow rapidly and form the new shoot and root. The seed contains a limited store of **carbohydrate** and **lipid**, which it uses as a fuel for respiration to provide the energy for growth. During this stage the seed must produce leaves so it can begin to photosynthesize. The danger is that the seed will run out of stored energy before it makes leaves. If this happens it will die.

Plants can also reproduce asexually:

Natural methods	Artificial methods
<p><b>Runners</b> - a root from one plant grows a separate shoot, which grows into a new plant. Eventually the original root connecting the two plants breaks down, separating the plants</p> <p>See also <b>rhizomes, corms, bulbs and tubers</b> (not mentioned on syllabus)</p>	<p><b>Cuttings</b> - a branch from one plant is removed and planted in soil. It will grow new roots and become a new plant.</p> <p>See also <b>grafting</b> (not mentioned on syllabus)</p>

# Reproduction in Humans:

## Male reproductive System:

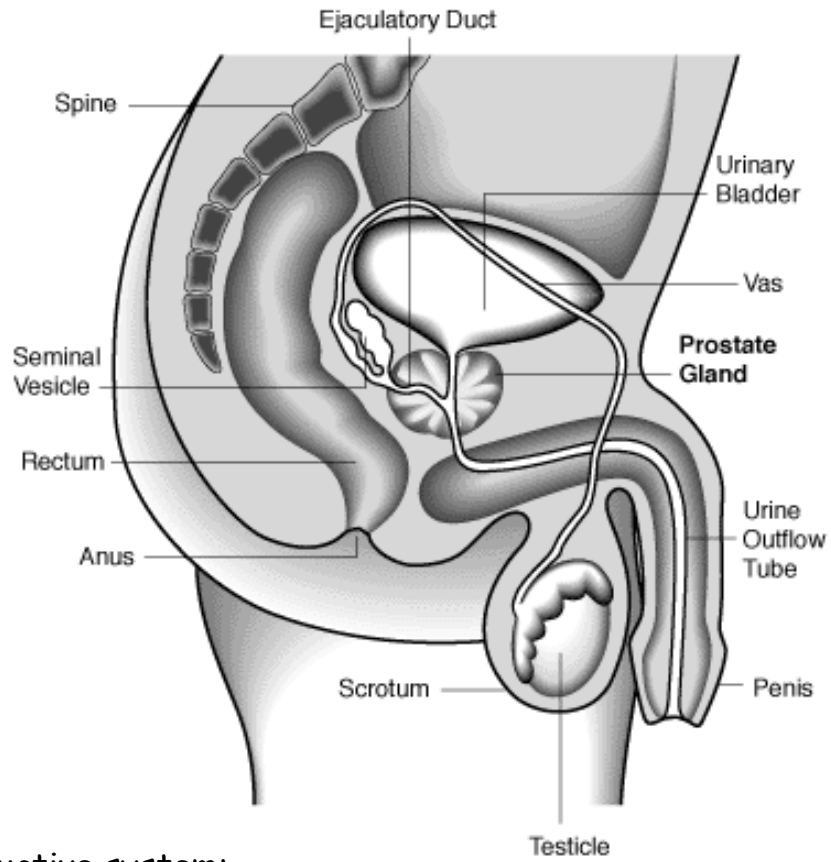

## Female reproductive system:

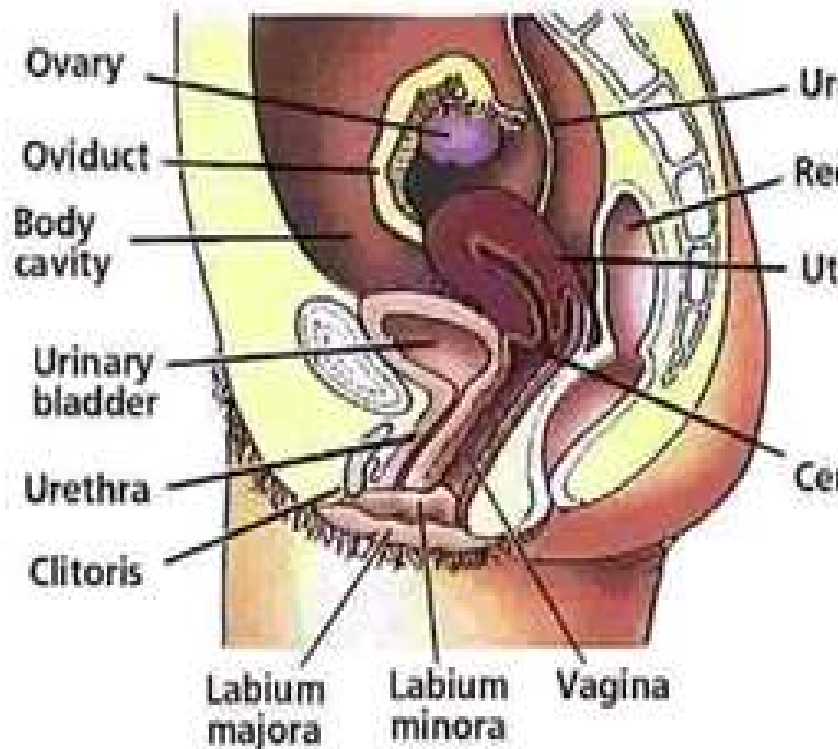

## Pregnancy:

When the egg and sperm fuse (fertilisation) the resulting **zygote** begins to divide by **mitosis** (see next section) and becomes an **embryo**. The embryo quickly develops a **placenta**, which brings the mother's blood supply very close to the foetus' blood supply. The two blood streams **never mix** (otherwise the mother's white blood cells would attack the foetus!), but they are close enough for diffusion to occur

Diffuse from foetus to mother -  $CO_2$ , water, urea

Diffuse from mother to foetus-  $O_2$ , glucose, amino acids, minerals

The placenta is adapted for diffusion in much the same way as other exchange organs, i.e. it has;

- Huge surface area (it has lots of villi-like projections)
- Only a few cells thick
- Blood supplies keep the concentration gradients high
- Counter-current system (this one's an A-level idea... look it up?!)

As well as the placenta the embryo also develops an **amnion** (membrane sac, which fills up with **amniotic fluid**). This helps cushion the embryo and protects it.

## Reproductive Hormones:

During puberty boys make **testosterone** in their **testes** and girls make **oestrogen** in their **ovaries**.

### **Testosterone:**

- Causes testes to drop & penis to enlarge
- Triggers spermatogenesis (sperm manufacture)
- Causes growth of pubic and body hair
- Causes larynx to enlarge (voice deepens)
- Causes muscles to grow

**Oestrogen:**

- Triggers menstruation to begin
- Causes maturation of vagina
- Causes breasts to grow
- Causes growth of pubic and body hair
- Causes hips to widen

Menstrual Cycle:

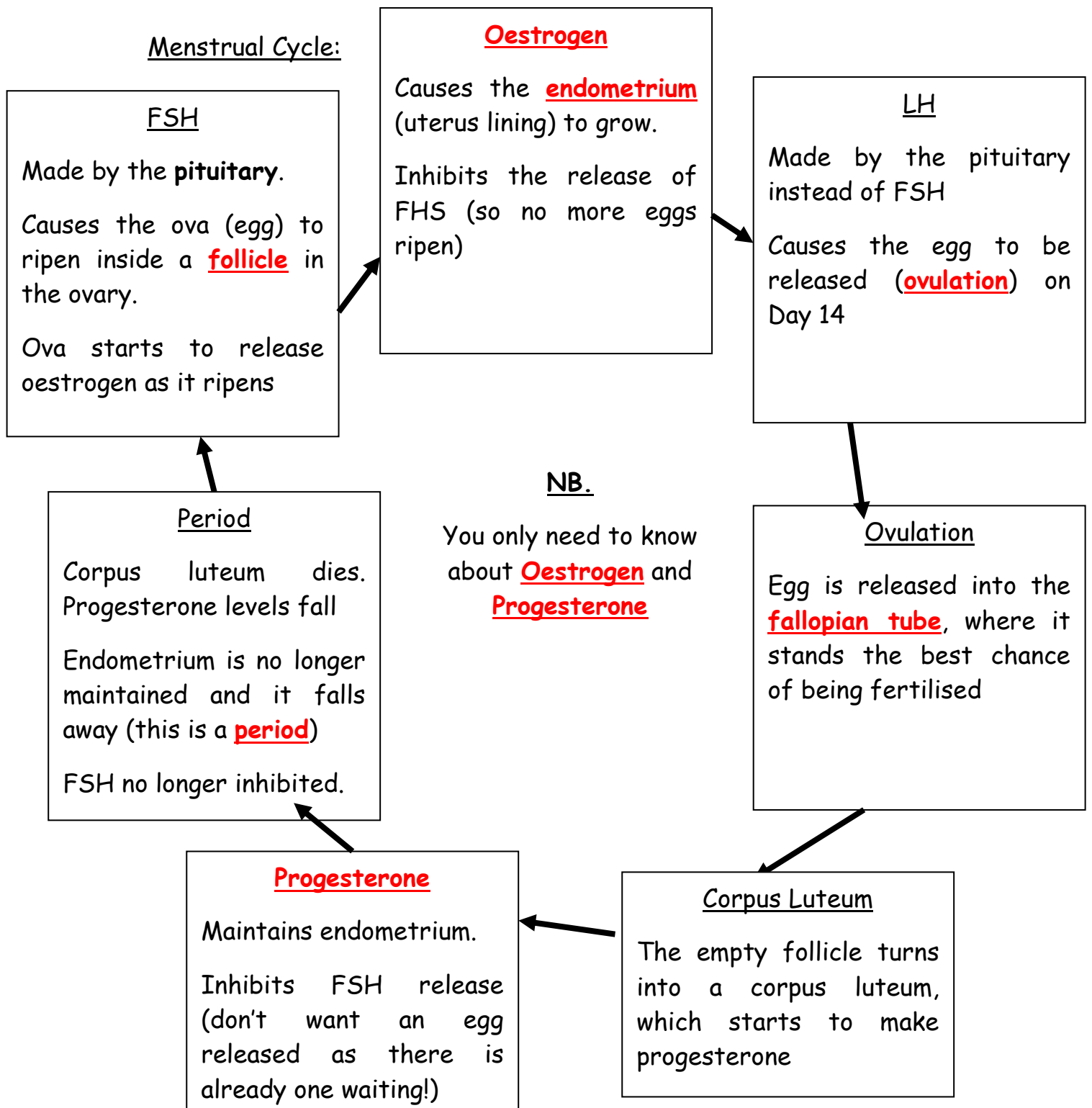

## b) Inheritance

The nucleus of every cell contains **DNA**. DNA is a **genetic code**. Each instruction in the code is called a **gene**. Each gene tells the cell how to make a **specific protein**. The proteins are what control the cell (e.g. enzymes are proteins, so are structural proteins like collagen). Sometimes more than one version of a gene occur. The different versions are called **alleles** (i.e. we all have the gene for iris pigment, but there are different colours of iris pigment, same gene but different alleles)

DNA is a very long molecule. To stop it from breaking it is coiled up inside the nucleus. The coiled up DNA forms a **chromosome**. Humans have 23 different chromosomes inside their cells. We have two copies of each chromosome, therefore, each cell contains 46 chromosomes. The **haploid number** is the number of different chromosomes (i.e. 23) and the **diploid number** is the total number of chromosomes in the cell (i.e. 46)

### Key Word Summary:

**This topic, more than any other, confuses people. Learn these thoroughly!**

**DNA:** A genetic code

**Gene:** One instruction in the code telling a cell how to make a **specific protein**

**Allele:** A different version of a gene

**Chromosome:** Coiled up DNA

**Haploid number:** the number of **different** chromosomes in a cell (23)

**Diploid number:** the **total number** of chromosomes in a cell (46)



Cell Division:

There are two types of cell division;

- **Mitosis** - used for growth, repair & asexual reproduction
- **Meiosis** - used to produce gametes for sexual reproduction

Mitosis	Meiosis
1. Produces <b>2 daughter cells</b>	1. Produces <b>4 gametes</b>
2. Daughter cells are <b>diploid</b> (i.e. only have 23 chromosomes)	2. Daughter cells are <b>haploid</b> (i.e. have 23 pairs of chromosomes)
3. Daughter cells are <b>genetically identical</b> to each other	3. Gametes are <b>genetically different</b> to each other
4. Daughter cells are <b>genetically identical</b> to parent cell	4. Gametes are <b>genetically different</b> to parent cell
5. Occurs in one stage	5. Occurs in two stages
6. Happens <b>everywhere</b> in the body	6. Happens in <b>reproductive organs</b> only

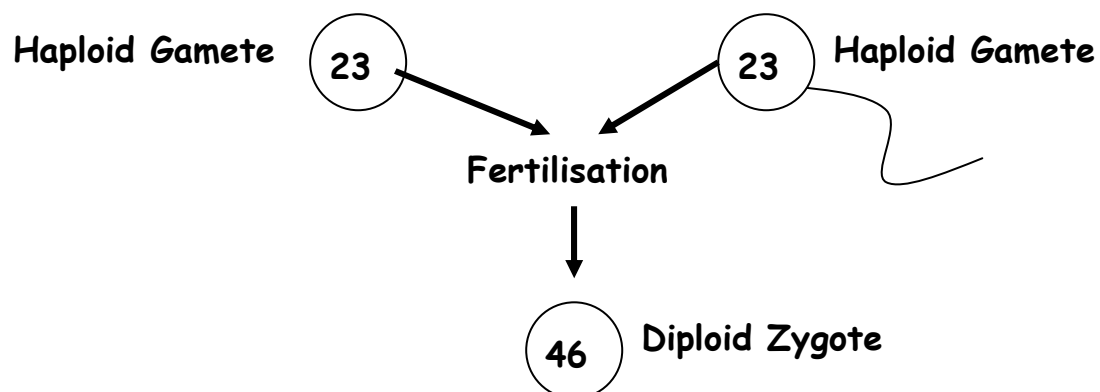

Therefore, fertilization produces a diploid cell (which will grow by mitosis) from two haploid gametes.

Each parent gives only **one** of each of the pairs of chromosomes to their gametes. A pair of chromosomes will have exactly the same genes on them, but not necessarily the same alleles! This is the source of genetic variation in gametes.

Alleles for the same gene can be;

- **Dominant** - always affect the **phenotype** (allele represented with capital letter)
- **Recessive** - never affect the phenotype in the presence of a dominant allele (allele represented with lower case letter)
- **Co-dominant** - affect the phenotype equally in the presence of another co-dominant allele (both alleles have capital letters)

Inheritance:

Inheritance patterns are always given using a **genetic diagram**. If this comes up you get loads of marks for it, but only if you use the genetic diagram!

### A Genetic Diagram

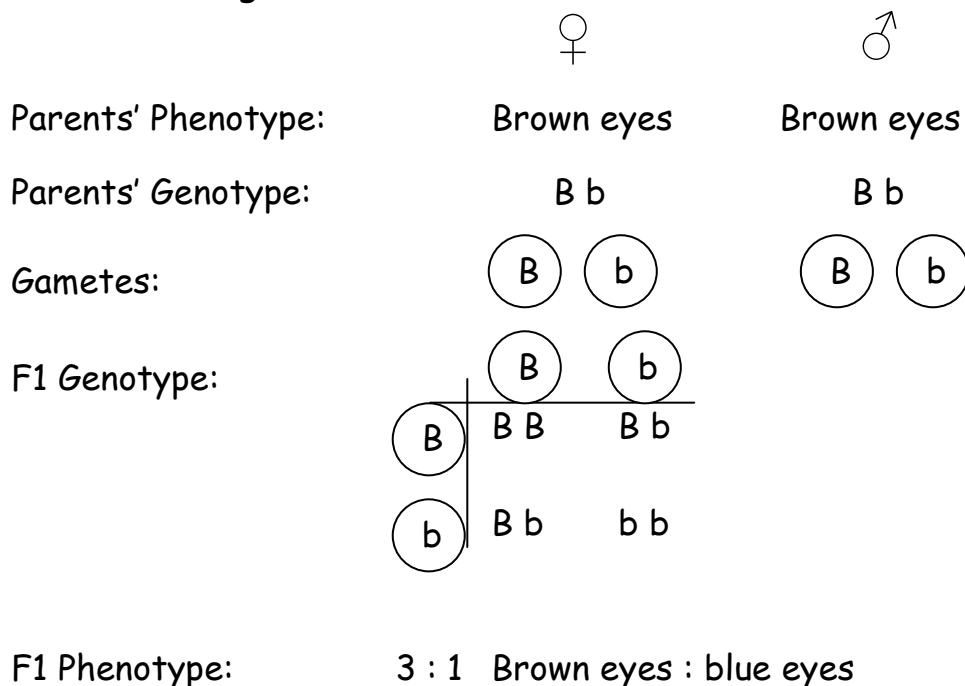

**Note the gametes are always put in circles**

More Key Words:

**Phenotype:** physical appearance

**Genotype:** the combination of alleles an individual possesses

**Heterozygous:** two different alleles in genotype (i.e. B b)

**Homozygous:** both alleles the same in genotype (i.e. B B or b b)

Inheritance of gender is governed by the 23<sup>rd</sup> chromosome. Boys have an X and a Y, girls have two X chromosomes

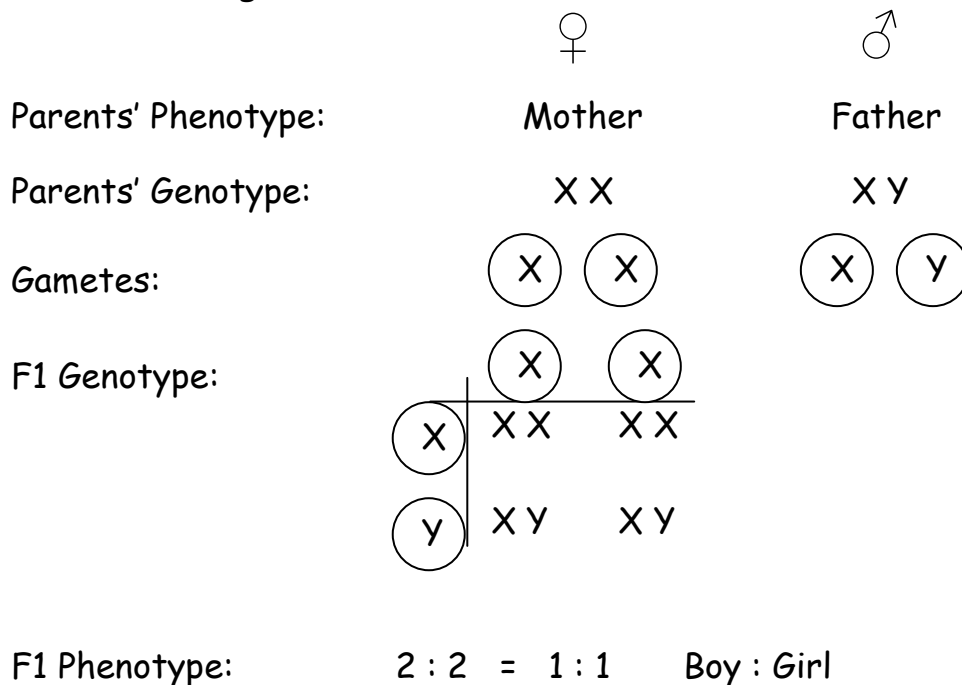
**A Genetic Diagram**

**Note the gender of the baby is determined by the sperm!**

Variation:

**Variation** within a species is produced by two factors

1. The environment
2. The genotype.

New alleles arise in the population through **mutation**

**Mutation** - a rare, random change in the genetic code of a gene.

The mutated gene will therefore produce a slightly different protein to the original non-mutant gene. The new protein might;

1. Work just as well as it did before (**neutral** mutation)
2. Work better than before (**beneficial** mutation)
3. Work worse / not at all (**harmful** mutation)

Beneficial mutations give a **selective advantage** to the individual. Individuals with this kind of mutated allele are more likely to survive, reproduce and pass their alleles on. This is the basis of **Natural Selection**

Natural Selection:

Darwin came up with this theory.

Darwin's 1<sup>st</sup> Observation: Not all individuals survive

Darwin's 2<sup>nd</sup> Observation: There is variation in a species

Darwin's Conclusion: The better adapted individuals survive (the "**fittest**") and reproduce, passing their alleles onto the next generation.

Over time this process leads to **evolution**.

**Evolution**: the formation of a new species from an original species

Mutations can be inherited or happen on their own. The frequency that mutation occurs naturally can be increased by exposure to **radiation** (e.g. gamma rays, X-rays and ultraviolet rays) and some chemical **mutagens** (e.g. chemicals in tobacco).

## Section 4: Ecology and the environment

### a) The organism in the environment

#### More lovely definitions for you to learn!

**Population:** all the individuals of a particular species within a defined area

**Community:** a group of different populations living in the same area

**Habitat:** the physical, chemical and biological environment in which an organism lives

**Ecosystem:** a community of living things and the environment in which they live

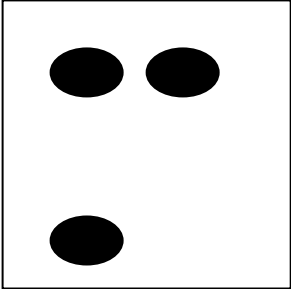
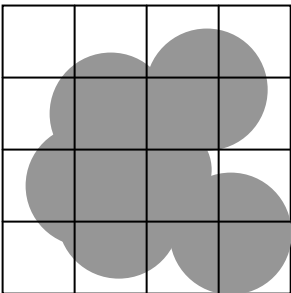
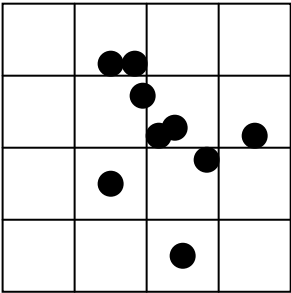
Quadrat	How it is used
	<p>A quadrat can be used to calculate the <b>total population</b> of a species (e.g. snails). Simply count the number of individuals in the quadrat. This technique only works for large organisms which can be distinguished as individuals (not always easy for plants, e.g. grass!)</p>
	<p>A quadrat can be used to calculate the <b>percentage cover</b> of a species (e.g. moss). The quadrat is divided into 100 smaller squares. The percentage cover of the quadrat is simply the number of squares filled with the species.</p>
	<p>A quadrat can be used to calculate the <b>percentage frequency</b> of a species (e.g. daisies in a field). The quadrat is divided into 100 smaller squares. You simply count a 1 for each square the species is in and a 0 for those where it is absent. This gives you an indication of the frequency of the species, it does not tell you the total population.</p>

In ecology we usually need to **sample** (this is because it is not practical to count all of the species we're interested in e.g. one cannot count all of the grass plants in a field!). Ecologists use **quadrats** to sample from.

*Quadrats can be any size you like (e.g. 5km by 5km sampling zebra herds in Africa, or 5cm by 5cm sampling lichen on a tree), but there are 3 different methods of using a quadrat. You need to be able to explain how you would use quadrats to find out information about specific species in their habitat.*

## b) Feeding relationships

Food chains are used to show the relationships between species in a habitat. E.g.

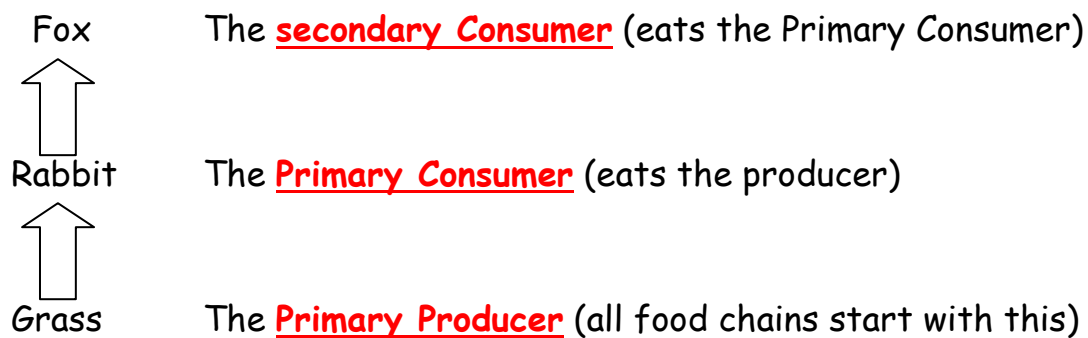

Each level in a food chain is called a **Trophic Level**

Food chains can be built up into complex **food webs**. The difference between food chains and food webs is that food webs have **branches**, chains never do.

## A Pyramid of Numbers

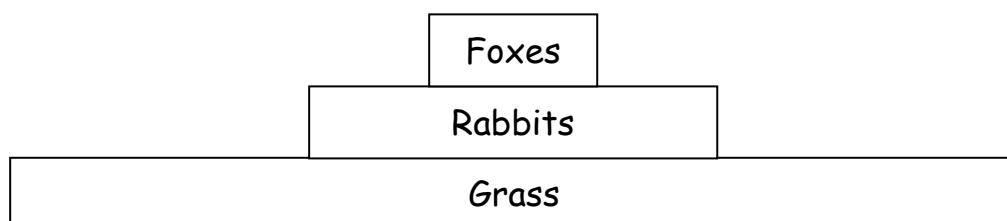

This shows the **populations** (to scale) of the species in the chain

Sometimes a Pyramid of numbers can be inverted (i.e. have a tiny base). This occurs if there is a **parasitic relationship** in the food chain i.e. one tree, but many caterpillars eating the leaves!

To stop this a pyramid of biomass is more frequently used. This always has a pyramidal shape.

### A Pyramid of Biomass

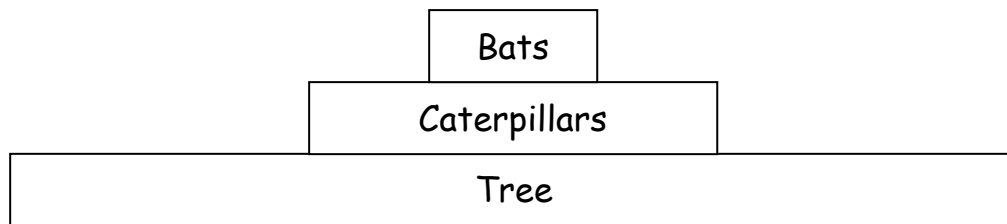

**Biomass** - the mass of the organic material an organism is made from (i.e. dry it out totally and weigh it, water doesn't count!)

We can also represent the energy flow in a food chain using a **Pyramid of Energy Transfer**.

### A Pyramid of Energy Transfer

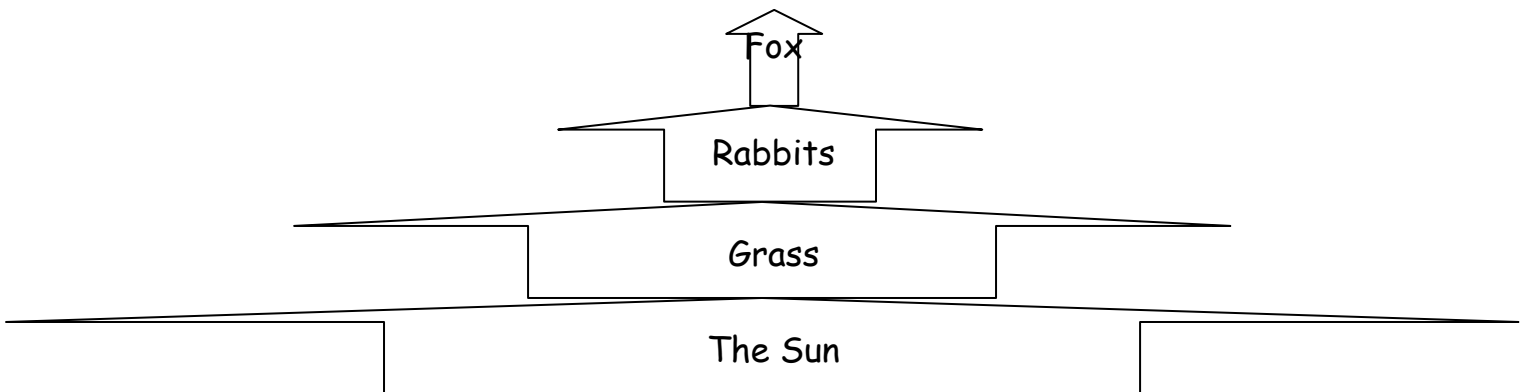

This gives an indication of the huge amount of **energy** that is not passed on to the next trophic level. This is because at each level energy is wasted on;

- Respiration (most of it as waste heat)
- Undigested / egested food
- Used in movement

The Water Cycle:

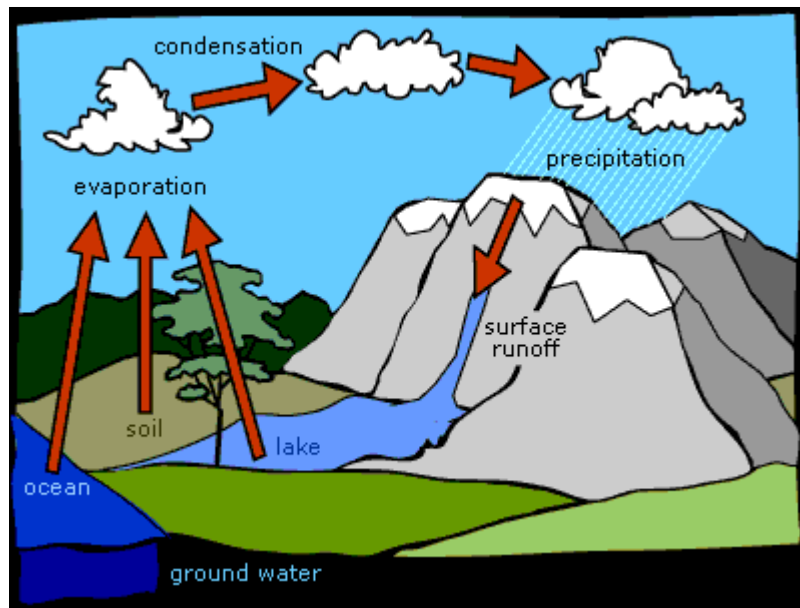

Key ideas - **Evaporation**, **Condensation**, **Precipitation** & **Transpiration** (rather unhelpfully not shown on this diagram)

The Carbon Cycle:

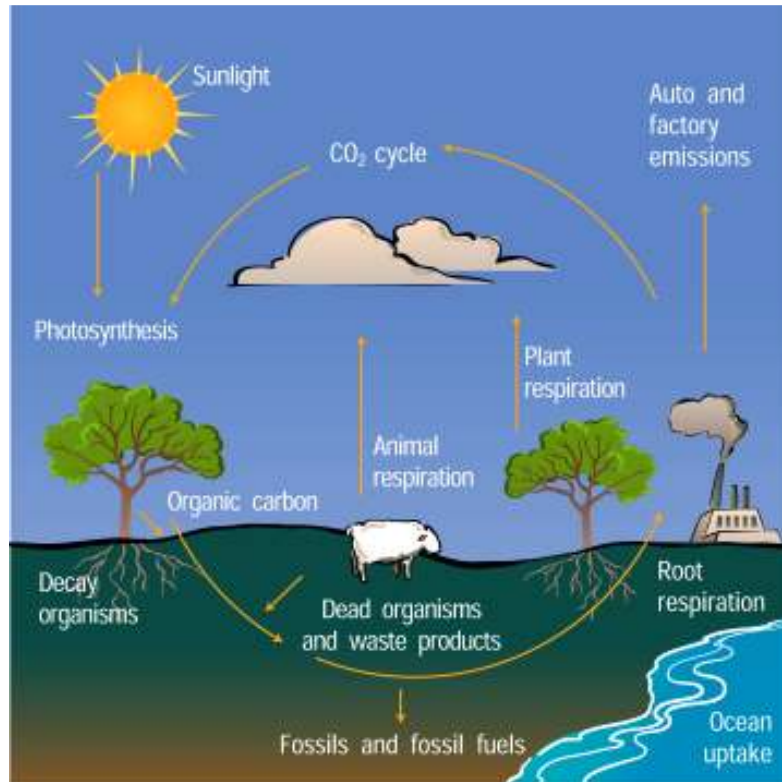

Key ideas - **Respiration**, **Photosynthesis**, **Decomposition** & **Combustion**

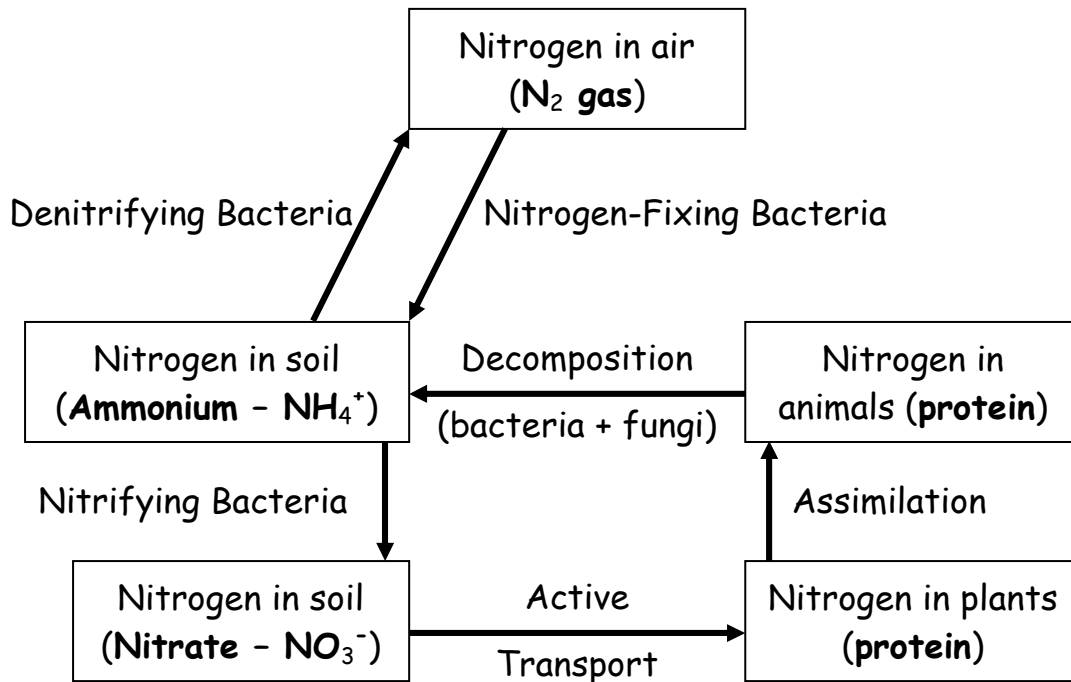

The Nitrogen Cycle:

This is not particularly easy to understand. You need to know the roles of all the different bacteria. There are 4;

- **Decomposers** - turn nitrogen in protein into ammonium ( $NH_4^+$ )
- **Denitrifying Bacteria** - turn ammonium ( $NH_4^+$ ) into  $N_2$
- **Nitrifying bacteria** - turn ammonium ( $NH_4^+$ ) into nitrate ( $NO_3^-$ )
- **Nitrogen-fixing bacteria** - turn  $N_2$  into ammonium ( $NH_4^+$ )

**Extension - leguminous plants (not technically on syllabus)**

All of the above bacteria are naturally present in the soil. The only exception to this is that some Nitrogen-fixing bacteria (e.g. *Rhizobium*) live in the roots of some plants. These plants are called **legumes** (e.g. peas, clover etc). They have a **symbiotic** relationship with the bacteria i.e. both the bacteria and the plant benefit from working together.

## d) Human influence on the environment

You need to know about the following environmental problems:

- Acid rain
- Greenhouse effect
- Eutrophication
- Deforestation

### Acid rain:

SO<sub>2</sub>, CO<sub>2</sub> and NO<sub>x</sub> (oxides of nitrogen) dissolve in rain to form Sulphuric Acid, Carbonic Acid and Nitric Acid. This falls as acid rain, which destroys soil, pollutes waterways and causes erosion

### Greenhouse Effect:

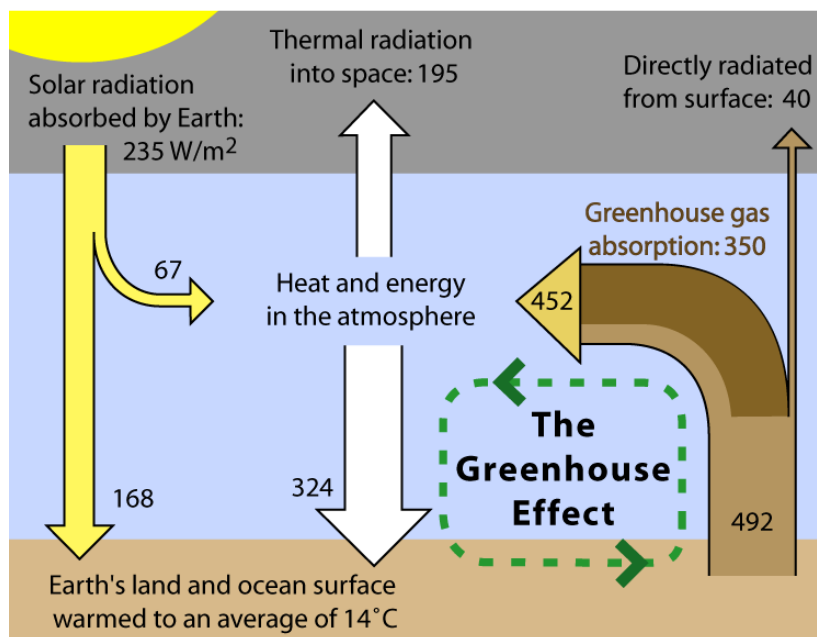

Incoming radiation passes through the atmosphere and hits the Earth, where it is **absorbed**. The Earth **re-emits** the radiation as longer-wavelength Infra-Red radiation. This is the problem. IR radiation is absorbed by **greenhouse gases** on its way out of the atmosphere. This traps the heat in the atmosphere.

The greenhouse gases are: **water vapour**, **CO<sub>2</sub>**, **NO<sub>x</sub>**, **methane** and **CFCs**

Greenhouse Gas	Source
Water Vapour	Humans haven't had much effect on this - its a naturally occurring greenhouse gas
CO <sub>2</sub>	Released from burning fossil fuels
NO <sub>x</sub>	Released from burning fossil fuels
Methane	Produced by cows (yes, cow farts) and rice paddy fields. As agriculture becomes more and more intensive methane emissions rise
CFCs	Used to be used as coolant in fridges and propellant in aerosols. Now banned, but there are still lots of old fridges in scrap yards leaking CFCs

The theory goes that the **greenhouse effect** is causing **global warming**, which is bad. Global warming might cause:

- Polar ice cap melting
- Sea levels rising
- Extinction of species living in cold climates
- Changes in rainfall (both droughts and flooding)
- Changes in species distribution (i.e. tropical species spreading, like mosquitoes)

#### Eutrophication:

1. **Nitrate** enters a waterway (**sewage** or **fertilizer run-off**)
2. Nitrate causes **algal bloom**
3. Algae block out light for plants living on the waterway bed
4. These plants respire as they can't photosynthesize
5. O<sub>2</sub> levels fall
6. Fish die
7. Dead fish are decomposed by bacteria, which themselves respire, using up more O<sub>2</sub>
8. pH levels fall as decomposition produces acids
9. Everything dies. Waterway is incapable of supporting life

## Deforestation:

Cutting down trees and not replacing them is bad. It causes;

- Leaching of soil minerals
- Soil erosion (no roots holding soil together)
- Desertion (new deserts forming)
- Disturbance of the water cycle (less transpiration can lead to flooding and / or drought)
- Increase in  $CO_2$  levels
- Decrease in  $O_2$  production

**Over-fishing** and **over-grazing** can cause food chains to collapse.

## Section 5: The use of Biological resources

### a) Food production

#### Food Production using Crop plants:

**Greenhouses** and **polythene tunnels** raise the temperature (by the greenhouse effect... guess why it's called that), which increases the rate of photosynthesis, which increases crop **yield**

**Yield** - The total mass of the edible part of crop

If the level of  $CO_2$  in the greenhouse is increased the yield will further increase (remember,  $CO_2$  is a limiting factor in p/s)

If fertilizers are added (specifically those that contain **Potassium**, **Nitrate** and **Phosphate**- **KNP fertilisers**) then the yield will increase even more!

**Potassium** - essential for plant membranes

**Nitrate** - essential for making plant proteins

**Phosphate** - essential for DNA and membranes

Pest Control can also be used to increase Yield. This can be done either using pesticides or biological controls.

**Pesticide** - a chemical that kills pests (anything that eats your crop), but does not harm the crop plant

**Biological control** - introducing a biological organism which will eat the pest, but not the crop plant (e.g. birds are sometimes encouraged inside greenhouses because they eat caterpillars)

### **Food Production using Microorganisms:**

#### **Yeast:**

Remember that **yeast** are capable of respiring **aerobically** (producing  $CO_2$  and water) and **anaerobically** (producing  $CO_2$  and ethanol). Yeast are therefore used in the brewing industry.

In order to make beer **barley** seeds are allowed to germinate by soaking the barley seeds in warm water. This is called **malting**. The germinating barley seeds break down their carbohydrate stores, releasing sugar. After a couple of days the barley seeds are gently roasted (which kills them) and put into a **fermenter** with yeast. The yeast use the sugar for **anaerobic respiration** and produce beer.

*You need to know an experiment that shows the production of  $CO_2$  by yeast, in different conditions. The best example is to mix a yeast suspension with a **sucrose** solution and place in a boiling tube with a delivery tube attached. Any  $CO_2$  produced can be collected over water or bubbled through lime water.*

#### **Lactobacillus:**

Lactobacillus bacterium is This bacterium is used to turn milk into yoghurt. It uses **lactose** sugar in the milk to produce **lactic acid** by **anaerobic respiration**. The lactic acid affects the milk proteins, making the yoghurt curdle (go solid) and giving it the characteristic tart taste.

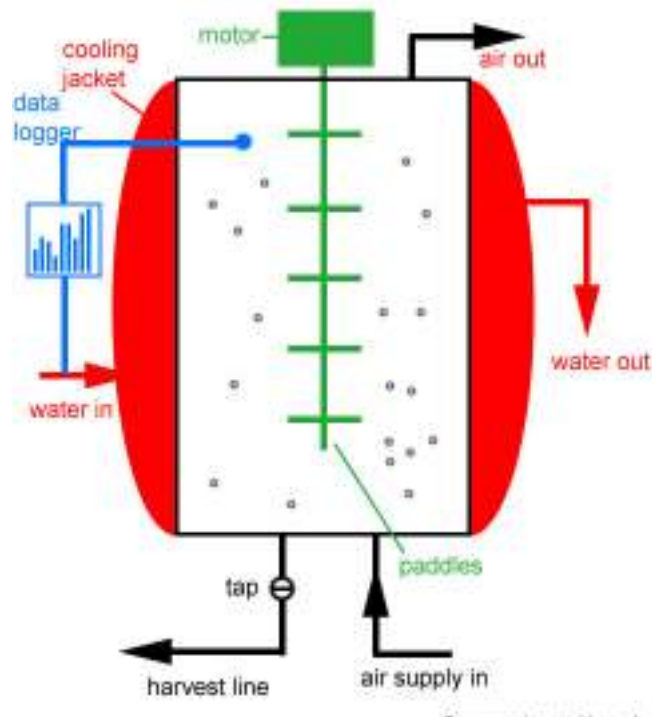

Important details:

**Cooling jacket** - keeps the microorganisms at optimum temperature. They will produce lots of heat through **respiration**, therefore need to be cooled!

**Paddles** - keep stirring the mixture. This stops waste products from building up and keeps the air evenly mixed

**Nutrient medium** - supplies the microorganisms with fuel for respiration

**Sterile Air supply** - supplies clean  $O_2$  for respiration (note: this is not required in anaerobic fermentation processes)

**Data-logger** - monitors temperature and pH, keeps the fermenter at optimum conditions

**You don't need to be able to draw this out, but you could be asked to label a diagram of a fermenter or be asked to explain the function of the various parts of a fermenter.**

## Food Production using Fish Farming:

Fish are farmed in **fish farms** because they are a good source of **protein**. Fish farms keep lots of fish in very small tanks to minimize space requirements. To stop the fish fighting with each other these precautions are taken;

- Different fish species are kept in separate tanks. This stops competition **between species** of fish (**intraspecific competition**)
- Fish of different genders are kept separately (unless they are being bred)
- Fish of different ages are kept separately. This stops competition between fish of the **same species** (**interspecific competition**)

As with the fermentation, the quality of the water is closely monitored and the fish are continuously supplied with fresh **sterile** water so that wastes are washed out constantly. The fish are kept in sterile water to limit disease, which would spread very quickly in the cramped ponds.

The fish are often over-fed, or fed with **protein-rich food**. Sometimes **hormones** are added to the water to **speed growth**. In addition to this only the biggest and most healthy fish are allowed to breed. This is an example of **selective breeding**.

### b) *Selective Breeding*

**Selective Breeding** - individuals with desired characteristics are bred together to produce offspring which express both desired characteristics.

Examples of this are: increased yield and reduction of stem length in **wheat** and increased yield of meat and milk in **cattle**.

## c) Genetic Modification (Genetic engineering)

### The structure of DNA:

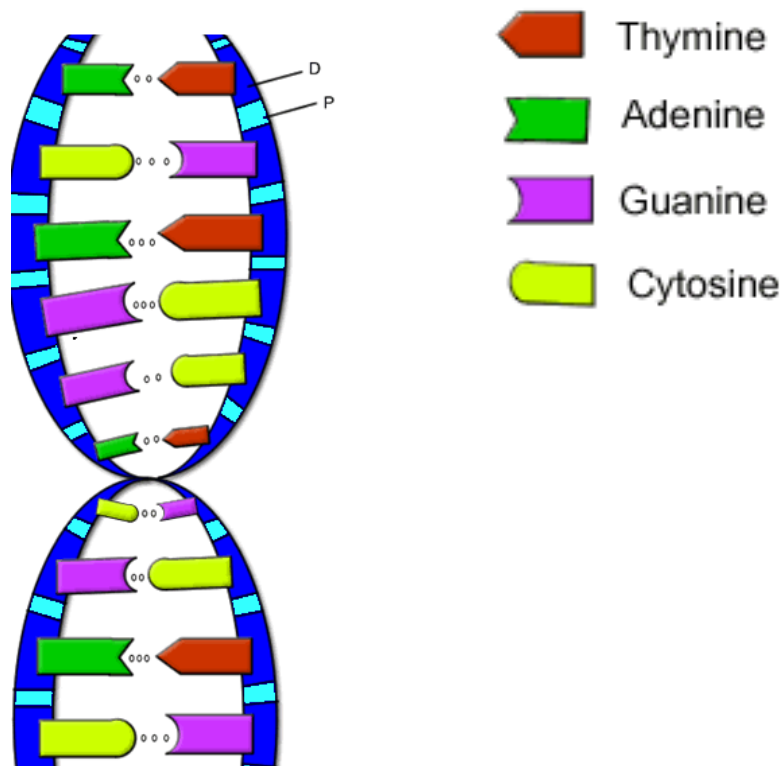

DNA is a **double-stranded** molecule. The strands coil up to form a **double-helix**. The strands are linked by a series of **paired bases**.

**Thymine** (T) pairs with **Adenine** (A)

**Guanine** (G) pairs with **Cytosine** (C)

The bases are a crucial part of DNA. The sequence of bases is what created the **genetic code!**

### Process of genetic engineering:

The example you need to know is the creation of *E coli* bacteria that makes human insulin.

However, a more fun example is *Alba*, the glow-in-the-dark bunny that makes the protein **luminol** (taken from a jellyfish!)

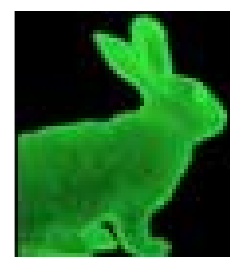



1. Extract target gene (human insulin gene) from donor cell. This is done by cutting the gene out of human DNA using a **restriction enzyme**
2. Cut open the bacterial DNA, also using the **restriction enzyme**
3. Insert the gene and "stitch the DNA together" using **DNA Ligase** enzyme
4. Get the new DNA into the bacterium. This is done using a **vector**

Common vectors include **Viruses** and **Plasmids**

Now your **transgenic** bacterium is complete. All you need to do is grow it in a **fermenter** and it makes lots of insulin for you!

**Transgenic Organism** - Organism containing DNA from two or more sources (i.e. an organism that's been genetically engineered to express a foreign gene)

Scientists are experimenting with genetic engineering all the time. Plants are good to genetically engineer because they are more simple and there are fewer ethical issues.

Genetically modified (GM) crops are engineered to:

- Have bigger yields
- Be frost resistant (e.g. frost resistant strawberries)
- Have resistance to disease
- Grow in harsher environments (e.g. drought-resistant rice)
- Have vitamins in them that they would not normally have (e.g. golden corn)
- Have a longer sell-by date (e.g. non-squash tomatoes)
- Be a different colour / taste to normal (e.g. chocolate carrots)
- Have stronger taste (e.g. chilis)
- Be easier to eat (e.g. easy-peel oranges)

## d) Cloning

Cloning is used to make many copies of a single individual. Usually the individual has a very **desirable phenotype** and has often been produced at the end of a **selective breeding** or **GE programme**.

### Cloning in plants:

The easiest way to clone a plant is to take a **cutting** or a graft (see earlier). However, **micropropagation** (tissue culture) can be used in large-scale cloning programmes.

**Micropropagation** - small pieces of plants (**explants**) are grown in a Petri dish on nutrient medium. Samples of the culture can be taken off and grown separately. If the right hormones are added the culture will turn into a miniature plant (a **plantlet**). This can be done on a huge scale to produce 1000s of plantlets from a single culture.

### Cloning in animals:

1. Take an **embryonic cell**
2. Remove it's nucleus (**enucleate** it)
3. Replace with the nucleus from an adult cell (from the animal you want to clone)
4. The embryonic cell grows into an embryo clone of the adult, from which the donor nucleus came

This process was used to create **Dolly the sheep**

Cloning can be used **beneficially** in agriculture to increase the yield of crop plants. However, cloning genetically engineered animals organisms allows us to mass-produce very useful organisms e.g. the *E. coli* bacterium that makes human insulin has been cloned many times. Now all diabetics have access to human insulin.

The END!